

Copyright Notice

This documentation and the software included with this product are copyrighted 2003 by Advantech Co., Ltd. All rights are reserved. Advantech Co., Ltd. reserves the right to make improvements in the products described in this manual at any time without notice. No part of this manual may be reproduced, copied, translated or transmitted in any form or by any means without the prior written permission of Advantech Co., Ltd. Information provided in this manual is intended to be accurate and reliable. However, Advantech Co., Ltd. assumes no responsibility for its use, nor for any infringements of the rights of third parties which may result from its use.

Acknowledgments

PC-LabCard is a trademark of Advantech Co., Ltd. IBM and PC are trademarks of International Business Machines Corporation. MS-DOS, Windows, Microsoft Visual C++ and Visual BASIC are trademarks of Microsoft Corporation. Intel and Pentium are trademarks of Intel Corporation. Delphi and C++ Builder are trademarks of Borland Software Corporation.

CE notification

The PCI-1710/1710L/1710HG/1710HGL/1711/1711L/1716/1716L, developed by ADVANTECH CO., LTD., has passed the CE test for environmental specifications when shielded cables are used for external wiring. We recommend the use of shielded cables. This kind of cable is available from Advantech. Please contact your local supplier for ordering information.

On-line Technical Support

For technical support and service, please visit our support website at:

<http://www.advantech.com/support>

Part No.: 2000000041

2nd Edition

Printed in Taiwan

November 2003

(This page is left blank for hard printing.)

Contents

1. Introduction	3
1.1 Features	5
1.2 Installation Guide	9
1.3 Software	11
1.4 Accessories	12
2. Installation	17
2.1 Unpacking	17
2.2 Driver Installation	19
2.3 Hardware Installation	21
2.4 Device Setup & Configuration	24
2.5 Device Testing	28
3. Signal Connections	37
3.1 Overview	37
3.2 I/O Connector	37
3.3 Analog Input Connections	41
3.4 Analog Output Connections	46
3.5 Trigger Source Connections	47
3.6 Field Wiring Considerations	48
4. Software Overview	53
4.1 Programming Choices	53
4.2 DLL Driver Programming Roadmap	54
5. Calibration	61
5.1 PCI-1710/1710L/1710HG/1710HGL Calibration	62

5.2 PCI-1711/1711L Calibration.....	67
5.3 PCI-1716/1716L Calibration	71
Appendix A. Specifications	87
A.1 PCI-1710/1710L/1710HG/1710HGL	87
A.2 PCI-1711/1711L Specifications	90
A.3 PCI-1716/1716L Specifications	92
Appendix B. Block Diagrams	95
B.1 Block Diagram of PCI-1710/1710L/1710HG/1710HGL	95
B.2 Block Diagram of PCI-1711/1711L.....	96
B.3 Block Diagram of PCI-1716/1716L	97
Appendix C. Register Structure and Format.....	99
C.1 Overview.....	99
C.2 I/O Port Address Map.....	100
C.3 Channel Number and A/D Data — BASE+0 and BASE+1	107
C.4 Software A/D Trigger — BASE+0.....	109
C.5 A/D Channel Range Setting — BASE+2	110
C.6 MUX Control — BASE+4 and BASE+5.....	114
C.7 Control Register — BASE+6	118
C.8 Status Register — BASE+6 and BASE+7	121
C.9 Clear Interrupt and FIFO — BASE+8 and BASE+9.....	122
C.10 D/A Output Channel 0 — BASE+10 and BASE+11	122
C.11 D/A Output Channel 0 — BASE+10 and BASE+11	123
C.12 D/A Output Channel 1 — BASE+12 and BASE+13	124
C.13 D/A Output Channel 1 — BASE+12 and BASE+13	125
C.14 D/A Reference Control —BASE+14	126

C.15 Digital I/O Registers — BASE+16 and BASE+17	128
C.16 Calibration Registers — BASE+18 and BASE+19.....	129
C.17 Board ID Registers — BASE+20.....	131
C.18 Programmable Timer/Counter Registers BASE+24, BASE+26, BASE+28 and BASE+30.....	131
Appendix D. 82C54 Counter Chip Function	133
D.1 The Intel 82C54	133
D.2 Counter Read/Write and Control Registers.....	135
D.3 Counter Operating Modes.....	139
D.4 Counter Operations	142
Appendix E. PCI-1716/1716L Calibration (Manually).....	145
E.1 A/D Calibration	145
E.2 D/A Calibration (for PCI-1716 only).....	148
Appendix F. Screw-terminal Board.....	153
F.1 Introduction	153
F.2 Features	154
F.3 Applications.....	154

(This page is left blank for hard printing.)

Tables

Table 3-1 I/O Connector Signal Description	40
Table C-1 PCI-1710/1710L/1710HG/1710HGL/1711/1711L register format (Part 1)	101
Table C-1 PCI-1716/1716L register format (Part 2)	102
Table C-1 PCI-1710/1710L/1710HG/1710HGL/1711/1711L/ 1716/1716L register format (Part 3)	103
Table C-1 PCI-1710/1710L/1710HG/1710HGL/1711/1711L register format (Part 4)	104
Table C-1 PCI-1716/1716L register format (Part 5)	105
Table C-1 PCI-1710/1710L/1710HG/1710HGL/1711/1711L/ 1716/1716L register format (Part 6)	106
Table C-2 PCI-1710/1710L/1710HG/1710HGL/1711/1711L Register for channel number and A/D data	107
Table C-3 PCI-1716/1716L Register for A/D data	108
Table C-4 Register for A/D channel range setting	110
Table C-5 Gain codes for PCI-1710/1710L	111
Table C-6 Gain codes for PCI-1710HG/1710HGL	112
Table C-7 Gain codes for PCI-1711/1711L	113
Table C-8 Register for multiplexer control	114
Table C-9 Control Register	118
Table C-10 Status Register	121
Table C-11 Register to clear interrupt and FIFO	122
Table C-12 Register for load D/A channel 0 data	122
Table C-13 Register for D/A channel 0 data	123

Table C-14 Register for load D/A channel 1 data	124
Table C-15 Register for D/A channel 1 data	125
Table C-16 PCI-1710/1710HG/1711 Register for D/A reference control....	126
Table C-17 PCI-1716 Register for D/A reference control	126
Table C-18 Register for digital input	128
Table C-19 Register for digital output.....	128
Table C-20 Calibration Command and Data Register	129
Table C-21 Calibration Command and Data Register	130
Table C-22 Register for Board ID	131
Table E-1 A/D binary code table	147
Table E-2 D/A binary code table	151

Figures

Fig.1-1 Installation Flow Chart	10
Fig.2-1 The Setup Screen of Advantech Automation Software	19
Fig.2-2 Different options for Driver Setup.....	20
Fig.2-3 The device name listed on the Device Manager	23
Fig. 2-4 The Device Manager dialog box.....	25
Fig. 2-5 Selecting the device you want to install	25
Fig. 2-6 The Device Setting dialog box.....	26
Fig. 2-7 The Device Name appearing on the list of devices box	27
Fig. 2-8 Analog Input tab on the Device Test dialog box.....	28
Fig. 2-9 Analog Input tab on the Device Test dialog box.....	29
Fig. 2-10 Analog Output tab on the Device Test dialog box.....	30
Fig. 2-11 Digital Input tab on the Device Test dialog box.....	31
Fig. 2-12 Digital Output tab on the Device Test dialog box	32
Fig. 2-13 Counter tab on the Device Test dialog box.....	33
Fig. 3-1 I/O connector pin assignments for the PCI-1710/ 1710L/1710HG/1710HGL/1711/1711L/1716/1716L	39
Fig. 3-2 Single-ended input channel connection.....	42
Fig. 3-3 Differential input channel connection - ground reference signal source.....	43
Fig. 3-4 Differential input channel connection - floating signal source.....	44
Fig. 3-5 Analog output connections	46
Fig. 5-1 PCI-1710/1710L/L1710HG/1710HGL VR assignment	63
Fig. 5-2 PCI-1711/1711L VR assignment	68
Fig. 5-3 PCI-1716/1716L VR assignment.....	71

Fig. 5-4 Selecting the device you want to calibrate	73
Fig. 5-5 Warning message before start calibration	73
Fig. 5-6 Auto A/D Calibration Dialog Box	74
Fig. 5-7 A/D Calibration Procedure 1	74
Fig. 5-8 A/D Calibration Procedure 2	75
Fig. 5-9 A/D Calibration Procedure 3	75
Fig. 5-10 A/D Calibration is finished	76
Fig. 5-11 Range Selection in D/A Calibration	77
Fig. 5-12 Calibrating D/A Channel 0	77
Fig. 5-13 Calibrating D/A Channel 1	78
Fig. 5-14 D/A Calibration is finished	78
Fig. 5-15 Selecting Input Range in Manual A/D Calibration panel	80
Fig. 5-16 Adjusting registers	80
Fig. 5-17 & Fig. 5-18 Selecting D/A Range and Choosing Output Voltage	82
Fig. 5-19 Adjusting registers	83

CHAPTER

1

Introduction

(This page is left blank for hard printing.)

1. Introduction

Thank you for buying the Advantech PCI-1710/1710L/1710HG/1710HGL/1711/1711L/1716/1716L PCI card. The Advantech PCI-1710/1710L/1710HG/1710HGL/1711/1711L/1716/1716L is a powerful data acquisition (DAS) card for the PCI bus. It features a unique circuit design and complete functions for data acquisition and control, including A/D conversion, D/A conversion, digital input, digital output, and counter/timer. PCI-1710/1710L/1710HG/1710HGL/1711/1711L/1716/1716L provides specific functions for different user requirements:

The Advantech PCI-1710/1710L/1710HG/1710HGL/1711/1711L/1716/1716L is a powerful data acquisition (DAS) card for the PCI bus. It features a unique circuit design and complete functions for data acquisition and control, including A/D conversion, D/A conversion, digital input, digital output, and counter/timer.

PCI-1710/1710L/1710HG/1710HGL/1711/1711L/1716/1716L provides specific functions for different user requirements:

PCI-1710	12-bit, 100kS/s Multifunction card
PCI-1710L	12-bit, 100kS/s Multifunction card w/o analog output
PCI-1710HG	12-bit, 100kS/s High-Gain Multifunction card
PCI-1710HGL	12-bit, 100kS/s High-Gain Multifunction card

	w/o analog output
PCI-1711	12-bit, 100kS/s 16-ch S.E. Inputs Low-cost Multifunction card
PCI-1711L	12-bit, 100kS/s 16-ch S.E. Inputs Low-cost Multifunction card w/o analog output
PCI-1716	16-bit, 250kS/s High-Resolution Multifunction card
PCI-1716L	16-bit, 250kS/s High-Resolution Multifunction card w/o analog output

The following sections of this chapter will provide further information about features of the multifunction cards, a Quick Start for installation, together with some brief information on software and accessories for the PCI-1710/1710L/1710HG/1710HGL/1711/1711L/1716/1716L card.

1.1 Features

The Advantech PCI-1710/1710L/1710HG/1710HGL/1711/1711L/1716/1716L provides users with the most requested measurement and control functions as below:

- ◆ PCI-bus mastering for data transfer
- ◆ 16-channel Single-Ended or 8 differential A/D Input
- ◆ 12-bit A/D conversion with up to 100 kHz sampling rate (PCI-1710/1710L/1710HG/1710HGL/1711/1711L)
- ◆ 16-bit A/D conversion with up to 250 kHz sampling rate (PCI-1716/1716L)
- ◆ Programmable gain for each input channel (only for PCI-1710/1710L/1710HG/1710HGL/1716/1716L)
- ◆ On board samples FIFO buffer:
4K for PCI-1710/1710L/1710HG/1710HGL, 1K for PCI-1716/1716L
- ◆ 2-channel D/A Output (PCI-1710/1710HG/1711/1716)
- ◆ 16-channel Digital Input
- ◆ 16-channel Digital Output
- ◆ Programmable Counter/Timer
- ◆ Automatic Channel/Gain Scanning
- ◆ Board ID

The Advantech PCI-1710/1710L/1710HG/1710HGL/1711/1711L/1716/1716L offers the following main features:

Plug-and-Play Function

The Advantech PCI-1710/1710L/1710HG/1710HGL/1711/1711L/1716/1716L is a Plug-and-Play device, which fully complies with the PCI Specification. Rev 2.1 for PCI-1710/1710L/1710HG/1710HGL/1711/1711L, and Rev 2.2 for PCI-1716/1716L. During card installation, all bus-related configurations such as base I/O address and interrupts are conveniently taken care of by the Plug-and-Play function. You have virtually no need to set any jumpers or DIP switches.

Flexible Input Type and Range Settings

The PCI-1710/1710L/1710HG/1710HGL/1711/1711L/1716/1716L features an automatic channel/gain scanning circuit. This circuit design controls multiplexer switching during sampling. Users can set different gain values for each channel according to their needs for the corresponding range of input voltage. The gain value settings thus selected is stored in the SRAM. This flexible design enables multi-channel and high-speed sampling for high-performance data acquisition.

On-board FIFO (First-In-First-Out) Memory

The PCI-1710/1710L/1710HG/1710HGL/1711/1711L/1716/1716L provides an on-board FIFO memory buffer, storing up to 4K A/D samples. Users can either enable or disable the interrupt request feature of the FIFO buffer. While the interrupt request for FIFO is enabled, users are allowed to specify whether an interrupt request will be sent with each sampling action or only when the FIFO buffer is half saturated. This useful feature enables a continuous high-speed data transfer with a more predictable performance on operating systems.

Optional D/A Output for Cost Savings

The PCI-1710/1710HG/1711/1716 goes further with 2 analog output channels, while the PCI-1710L/1710HGL/1711L/1716L doesn't. It is for users to differentiate between the PCI-1710/1710HG/1711/1716 and the PCI-1710L/1710HGL/1711L/1716L according to what they really need as the best solution with no extra cost.

16 Digital Inputs and 16 Digital Outputs

The PCI-1710/1710L/1710HG/1710HGL/1711/1711L/1716/1716L provides 16 digital input channels and 16 digital output channels. Users are left with great flexibility to design and customize their applications according to their specific needs.

On-board Programmable Counter

The PCI-1710/1710L/1710HG/1710HGL/1711/1711L/1716/1716L is equipped with a programmable counter, which can serve as a pacer trigger for A/D conversions. The counter chip is an 82C54 or its equivalent, which incorporates three 16-bit counters on a 10 MHz clock. One of the three counters is used as an event counter for input channels or pulse generation. The other two are cascaded into a 32-bit timer for pacer triggering.

Short Circuit Protection

The PCI-1710/1710L/1710HG/1710HGL/1716/1716L is equipped with short circuit protection device (polyswitch) on the $+12V_{DC}$ / $+5V_{DC}$ power supply pins. If any of the power supply pins is shorted to ground (i.e. short circuit occurs), the protection device will shut off the current output automatically. After the short circuit has been released for about two minutes, the power supply pins will return to output current.

Note:

1. Pace trigger determines how fast A/D conversion will be done in pacer trigger mode.
 2. For detailed specifications of the PCI-1710/1710L/1710HG/1710HGL/1711/1711L/1716/1716L, please refer to *Appendix A, Specifications*.
-

1.2 Installation Guide

Before you install your PCI-1710/1710L/1710HG/1710HGL/1711/1711L/1716/1716L card, please make sure you have the following necessary components:

- ◆ **PCI-1710/1710L/1710HG/1710HGL/1711/1711L/1716/1716L**
Multifunction card
- ◆ **PCI-1710/1710L/1710HG/1710HGL/1711/1711L/1716/1716L**
User's Manual
- ◆ **Driver software** Advantech DLL drivers (included in the companion CD-ROM)
- ◆ **Wiring cable** PCL-10168
- ◆ **Wiring board** PCLD-8710, ADAM-3968
- ◆ **Computer** Personal computer or workstation with a PCI-bus slot (running *Windows 95/98/NT/2000/XP*)

Some other optional components are also available for enhanced operation:

- ◆ **Application software** ActiveDAQ, GeniDAQ or other third-party software packages

After you get the necessary components and maybe some of the accessories for enhanced operation of your Multifunction card, you can then begin the Installation procedures. *Fig. 1-1* on the next page provides a concise flow chart to give users a broad picture of the software and hardware installation procedures:

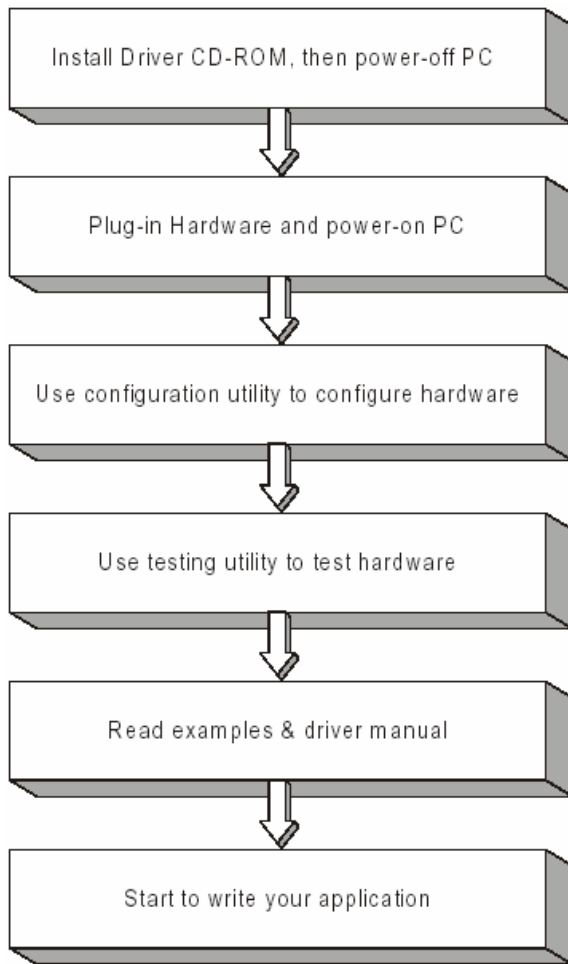

Fig.1-1 Installation Flow Chart

1.3 Software

Advantech offers a rich set of DLL drivers, third-party driver support and application software to help fully exploit the functions of your PCI-1710/1710L/1710HG/1710HGL/1711/1711L/1716/1716L card:

- ◆ DLL driver (on the companion CD-ROM)
- ◆ LabVIEW driver
- ◆ Advantech ActiveDAQ
- ◆ Advantech GeniDAQ

For more information on software, please refer to *Chapter 4, Software Overview*.

Users who intend to program directly at the registers of the Multifunction card can have register-level programming as an option. Since register-level programming is often difficult and laborious, it is usually recommended only for experienced programmers. For more information, please refer to *Appendix C, Register Structure and Format*.

1.4 Accessories

Advantech offers a complete set of accessory products to support the PCI-1710/1710L/1710HG/1710HGL/1711/1711L/1716/1716L cards.

These accessories include:

Wiring Cable

- **PCL-10168** The PCL-10168 shielded cable is specially designed for PCI-1710/1710L/1710HG/1710HGL/1711/1711L/1716/1716L cards to provide high resistance to noise. To achieve a better signal quality, the signal wires are twisted in such a way as to form a “twisted-pair cable”, reducing cross-talk and noise from other signal sources. Furthermore, its analog and digital lines are separately sheathed and shielded to neutralize EMI/EMC problems.

Wiring Boards

- **ADAM-3968** The ADAM-3968 is a 68-pin SCSI wiring terminal module for DIN-rail mounting. This terminal module can be readily connected to the Advantech PC-Lab cards and allow easy yet reliable access to individual pin connections for the PCI-1710/1710L/1710HG/1710HGL/1711/1711L/1716/1716L card.

- **PCLD-8710** The PCLD-8710 is a DIN-rail mounting screw-terminal board to be used with any of the PC-LabCards which have 68-pin SCSI connectors. The PCLD-8710 features the following functions:
 - ◆ Two additional 20-pin flat-cable connectors for digital input and output
 - ◆ Reserved space on the board to meet future needs for signal-conditioning circuits (e.g. low-pass filter, voltage attenuator and current shunt)
 - ◆ Industrial-grade screw-clamp terminal blocks for heavy-duty and reliable connections.

(This page is left blank for hard printing.)

CHAPTER
2

Installation

(This page is left blank for hard printing.)

2. Installation

This chapter gives users a package item checklist, proper instructions about unpacking and step-by-step procedures for both driver and card installation. Be noted that using PCI-1710 for example.

2.1 Unpacking

After receiving your PCI-1710/1710L/1710HG/1710HGL/1711/1711L/1716/1716L package, please inspect its contents first. The package should contain the following items:

- PCI-1710/1710L/1710HG/1710HGL/1711/1711L/1716/1716L card
- Companion CD-ROM (DLL driver included)
- User's Manual

The PCI-1710/1710L/1710HG/1710HGL/1711/1711L/1716/1716L card harbors certain electronic components vulnerable to electrostatic discharge (ESD). ESD could easily damage the integrated circuits and certain components if preventive measures are not carefully paid attention to. **Before removing the card from the antistatic plastic bag, you should take following precautions to ward off possible ESD damage:**

- ◆ Touch the metal part of your computer chassis with your hand to discharge static electricity accumulated on your body. Or one can also use a grounding strap.
- ◆ Touch the antistatic bag to a metal part of your computer chassis

before opening the bag.

- ◆ Take hold of the card only by the metal bracket when removing it out of the bag.

After taking out the card, first you should:

- ◆ Inspect the card for any possible signs of external damage (loose or damaged components, etc.). If the card is visibly damaged, please notify our service department or our local sales representative immediately. Avoid installing a damaged card into your system.

Also pay extra caution to the following aspects to ensure proper installation:

- ◆ Avoid physical contact with materials that could hold static electricity such as plastic, vinyl and Styrofoam.
- ◆ Whenever you handle the card, grasp it only by its edges. DO NOT TOUCH the exposed metal pins of the connector or the electronic components.

Note:

Keep the antistatic bag for future use. You might need the original bag to store the card if you have to remove the card from PC or transport it elsewhere.

2.2 Driver Installation

We recommend you to install the driver before you plug the PCI-1710/1710L/1710HG/1710HGL/1711/1711L/1716/1716L card into your system, since this will guarantee a smooth installation process.

The 32-bit DLL driver Setup program for the PCI-1710/1710L/1710HG/1710HGL/1711/1711L/1716/1716L card is included on the companion CD-ROM that is shipped with your DAS card package. Please follow the steps below to install the driver software:

Step 1: Insert the companion CD-ROM into your CD-ROM drive.

Step 2: The *Setup* program will be launched automatically if you have the *Autorun* function enabled on your system. When the *Setup* program is launched, you'll see the following setup screen.



Fig.2-1 The Setup Screen of Advantech Automation Software

Note:

If the autoplay function is not enabled on your computer, use Windows Explorer or Windows **Run** command to execute SETUP.EXE on the companion CD-ROM.

Step 3: Select the *Installation* option, then the *Individual Drivers* option.

Step 4: Select the specific device then just follow the installation instructions step by step to complete your device driver setup.

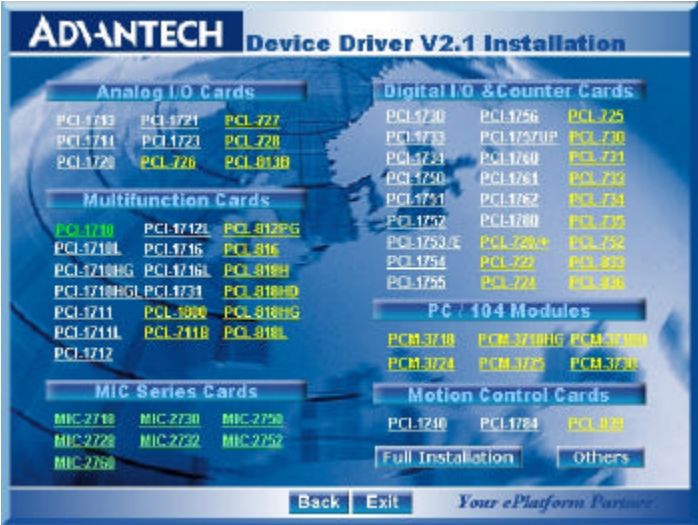

Fig.2-2 Different options for Driver Setup

For further information on driver-related issues, an online version of *DLL Drivers Manual* is available by accessing the following path:
Start/ Programs/ Advantech Automation/ Device Manager/ Device Driver's Manual

2.3 Hardware Installation

Note:

Make sure you have installed the driver first before you install the card (please refer to *2.2 Driver Installation*)

After the DLL driver installation is completed, you can now go on to install the PCI-1710/1710L/1710HG/1710HGL/1711/1711L/1716/1716L card in any PCI slot on your computer. But it is suggested that you should refer to the computer user manual or related documentations if you have any doubt. Please follow the steps below to install the card on your system:

Step 1: Turn off your computer and unplug the power cord and cables.

TURN OFF your computer before installing or removing any components on the computer.

Step 2: Remove the cover of your computer.

Step 3: Remove the slot cover on the back panel of your computer.

Step 4: Touch the metal part on the surface of your computer to neutralize the static electricity that might be on your body.

Step 5: Insert the PCI-1710/1710L/1710HG/1710HGL/1711/1711L/1716/1716L card into a PCI slot. Hold the card only by its edges and carefully align it with the slot. Insert the card firmly into place. Use of excessive force must be avoided, otherwise the card might be damaged.

Step 6: Fasten the bracket of the PCI card on the back panel rail of the computer with screws.

Step 7: Connect appropriate accessories (68-pin cable, wiring terminals, etc. if necessary) to the PCI card.

Step 8: Replace the cover of your computer chassis. Re-connect the cables you removed in step 2.

Step 9: Plug in the power cord and turn on the computer .

Note:

 In case you installed the card without installing the DLL driver first, *Windows 95/98* will recognize your card as an “unknown device” after rebooting, and will prompt you to provide the necessary driver. You should ignore the prompting messages (just click the **Cancel** button) and set up the driver according to the steps described in *2.2 Driver Installation*.

After the PCI-1710/1710L/1710HG/1710HGL/1711/1711L/1716/1716L card is installed, you can verify whether it is properly installed on your system in the *Device Manager*:

1. Access the *Device Manager* through **Star/ Control Panel/ System/ Device Manager**.
2. The device name of the PCI-1710/1710L/1710HG/1710HGL/1711/1711L/1716/1716L should be listed on the *Device Manager*.

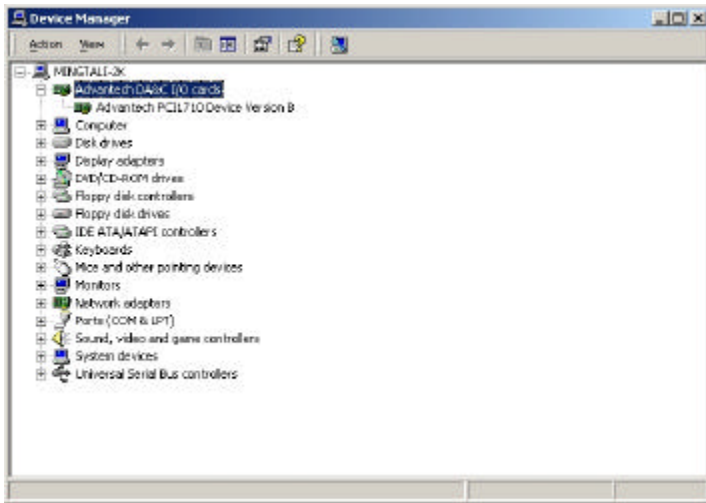

Fig.2-3 The device name listed on the Device Manager

Note:

If your card is properly installed, you should see the *device name* of your card listed on the *Device Manager* tab. **If you do see your device name listed on it but marked with an exclamation sign “!”, it means your card has not been correctly installed.** In this case, remove the card device from the *Device Manager* by selecting its device name and press the **Remove** button. Then go through the driver installation process again.

After your card is properly installed on your system, you can now configure your device using the *Device Manager* program that has itself already been installed on your system during driver setup. A complete device installation procedure should include device setup, configuration and testing. The following sections will guide you through the *setup*, *configuration* and *testing* of your device.

2.4 Device Setup & Configuration

The *Device Manager* program is a utility that allows you to set up, configure and test your device, and later stores your settings on the system registry. These settings will be used when you call the APIs of *Advantech Device Drivers*.

Setting Up the Device

Step 1: To install the I/O device for your card, you must first run the *Device Installation* program by accessing:

Start/ Programs/ Advantech Automation/ Device Manager/ Advantech Device Manager.

Step 2: You can then view the device(s) already installed on your system (if any) in the *Installed Devices* list box. Since you haven't installed any device yet, you might see a blank list such as the one in *Fig. 2-4.*

Step 3: Scroll down the *Supported Devices* box to find the device that you want to install, then click the *Add...* button to evoke the *Existing Unconfigured Device* dialog box such as the one shown in *Fig. 2-5.* The *Existing Unconfigured Device* dialog box lists all the installed devices of selected option on your system. Select the device you want to configure from the list box and press the **OK** button. After you have clicked **OK**, you will see a *Device Setting* dialog box such as the one in *Fig. 2-6.*



Fig. 2-4 The Device Manager dialog box

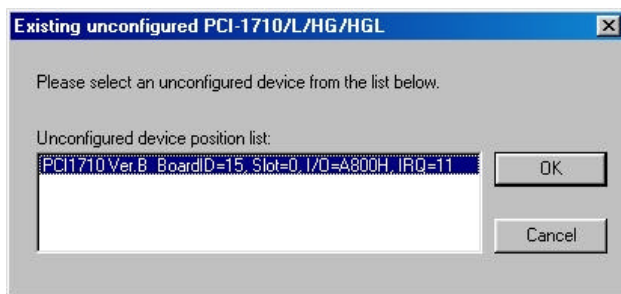

Fig. 2-5 Selecting the device you want to install

Configuring the Device

Step 4: On the *Device Setting* dialog box (Fig. 2-6), you can configure the voltage source either as External or Internal, and specify the voltage output range for the two D/A channels.



Fig. 2-6 *The Device Setting dialog box*

Note:

- 1 ?  Users can configure the source of D/A reference voltage either as *Internal* or *External*, and select the output voltage range. When selecting voltage source as **Internal**, users have two options for the output voltage range : **0 ~ 5 V** and **0 ~ 10 V**.
- 2 ? When selected as **External**, the output voltage range is determined by the external reference voltage in the following way :
- 3 ? **By inputting an external reference voltage: -xV , where |x| <= 10, you will get a output voltage range: 0 to xV.**

Step 5: After you have finished configuring the device, click **OK** and the device name will appear in the *Installed Devices* box as

Fig. 2-7.

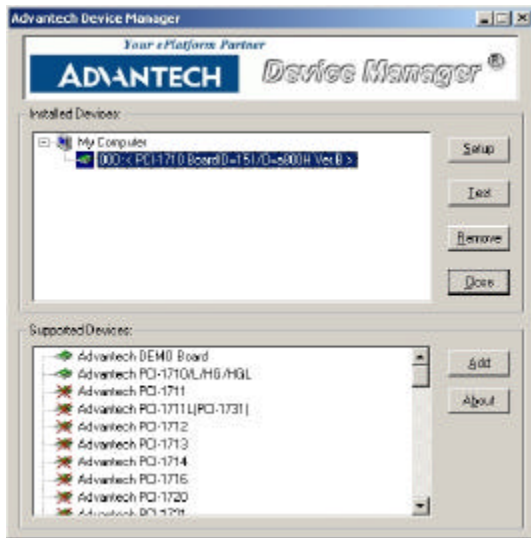

Fig. 2-7 *The Device Name appearing on the list of devices box*

Note:

As we have noted, the device name “**000: <PCI-1710 BoardID=15 I/O=a800H Ver.B>**” begins with a device number “000”, which is specifically assigned to each card. The device number is passed to the driver to specify which device you wish to control.

If you want to test the card device further, go right to the next section on the *Device Testing*.

2.5 Device Testing

Following through the *Setup* and *Configuration* procedures to the last step described in the previous section, you can now proceed to test the device by clicking the **Test** Button on the *Device Manager* dialog box (Fig. 2-8). A *Device Test* dialog box will appear accordingly:

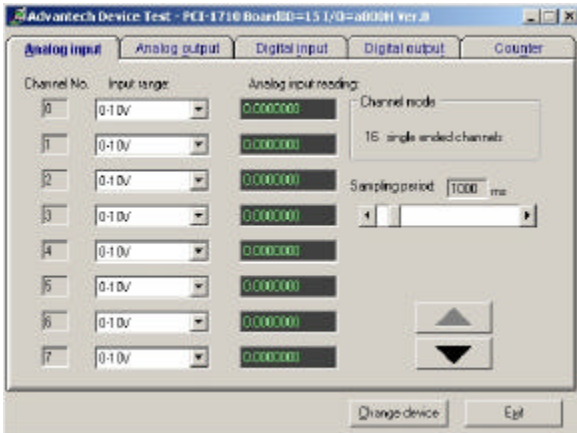

Fig. 2-8 Analog Input tab on the Device Test dialog box

On the *Device Test* dialog box, users are free to test various functions of PCI-1710/1710L/1710HG/1710HGL/1711/1711L/1716/1716L on the *Analog input*, *Digital input*, *Digital output* or *Counter* tabs. And the *Analog output* function only available for PCI-1710/1710HG/1711/1716.

Note:

- You can access the *Device Test* dialog box either by the previous procedure for the Device Installation Program or simply by accessing *Start/Programs/ Advantech Automation/ Device Manager/ Advantech Device Manager*.
- All the functions are performed by software polling method. For high speed data acquirement or output, they have to use corresponding VC example like ADINT or ADDMA or ADBMDMA.

Testing Analog Input Function

Click the *Analog Input* tab to bring it up to the front of the screen. Select the input range for each channel in the *Input range* drop-down boxes. Configure the sampling rate on the scroll bar. Switch the channels by using the up/down arrow.

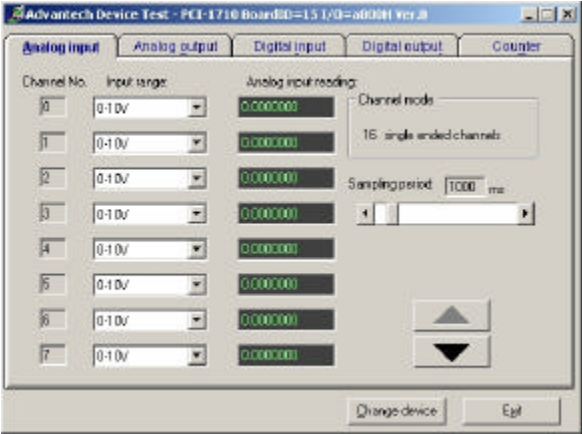

Fig. 2-9 Analog Input tab on the Device Test dialog box

Testing Analog Output Function (only for PCI-1710/ 1710HG/1711/1716)

Click the *Analog Output* tab to bring it up to the foreground. The *Analog Output* tab allows you to output quasi-sine, triangle, or square waveforms generated by the software automatically, or output single values manually. You can also configure the waveform frequency and output voltage range.

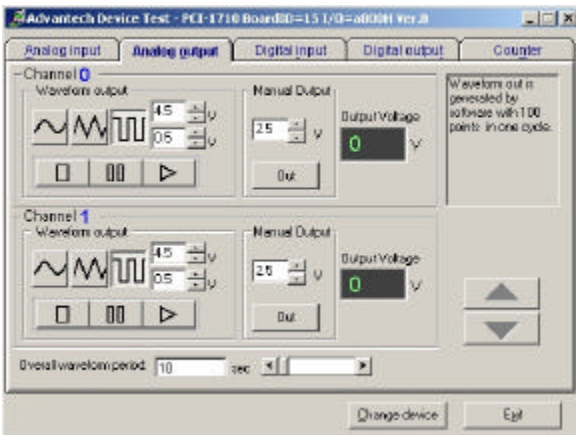

Fig. 2-10 *Analog Output tab on the Device Test dialog box*

Testing Digital Input Function

Click the *Digital Input* tab to show forth the *Digital Input* test panel as seen below. Through the color of the lamps, users can easily discern whether the status of each digital input channel is either high or low.

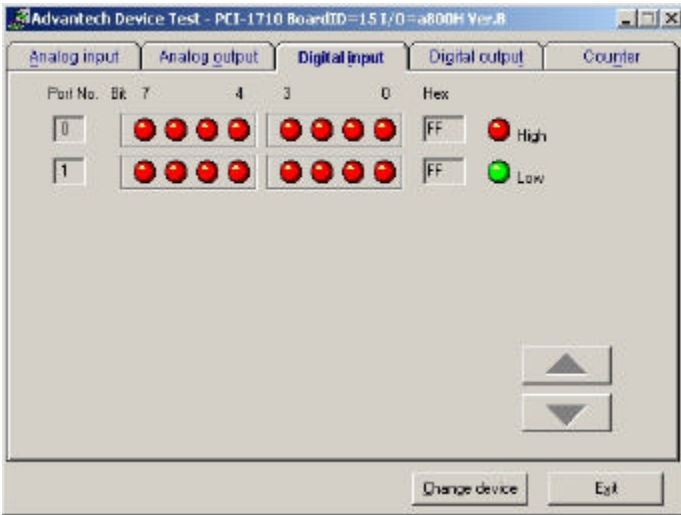

Fig. 2-11 Digital Input tab on the Device Test dialog box

Testing Digital Output Function

Click the *Digital Output* tab to bring up the *Digital Output* test panel such as the one seen on the next page. By pressing the buttons on each tab, users can easily set each digital output channel as *high* or *low* for the corresponding port.

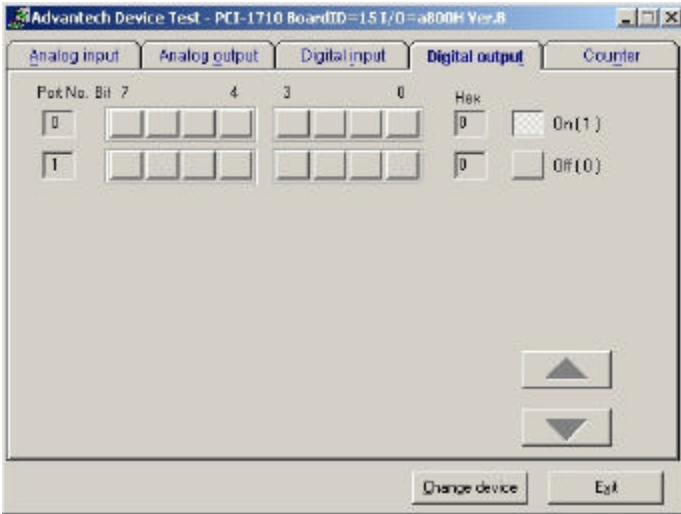

Fig. 2-12 *Digital Output* tab on the *Device Test* dialog box

Testing Counter Function

Click the *Counter* Tab to bring its test panel forth. The counter channel (*Channel 0*) offers the users two options: Event counting and Pulse out. If you select Event counting, you need first to connect your clock source to pin CNT0_CLK, and the counter will start counting after the pin CNT0_GATE is triggered. If you select Pulse Out, the clock source will be output to pin CNT0_OUT. You can configure the *Pulse Frequency* by the scroll bar right below it.

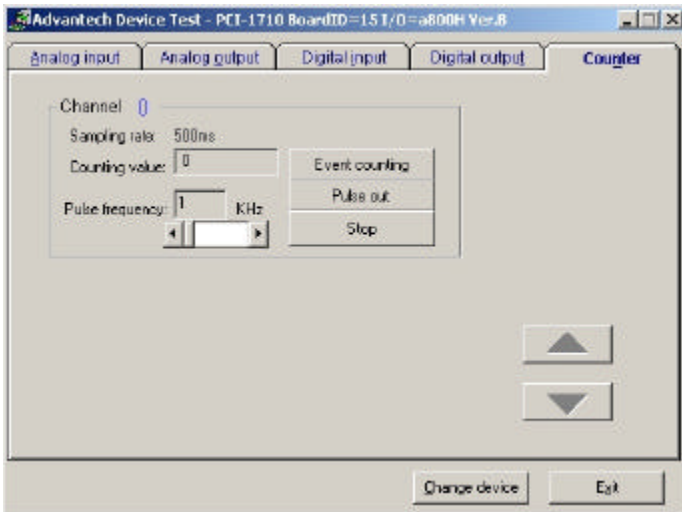

Fig. 2-13 Counter tab on the Device Test dialog box

Only after your card device is properly set up, configured and tested, can the device installation procedure be counted as complete. After the device installation procedure is completed, you can safely proceed to the next chapter, *Signal Connections*.

(This page is left blank for hard printing.)

CHAPTER
3

Signal Connections

(This page is left blank for hard printing.)

3. Signal Connections

3.1 Overview

Maintaining signal connections is one of the most important factors in ensuring that your application system is sending and receiving data correctly. A good signal connection can avoid unnecessary and costly damage to your PC and other hardware devices. This chapter provides useful information about how to connect input and output signals to the PCI-1710/1710L/1710HG/1710HGL/1711/1711L/1716/1716L via the I/O connector.

3.2 I/O Connector

The I/O connector on the PCI-1710/1710L/1710HG/1710HGL/1711/1711L/1716/1716L is a 68-pin connector that enable you to connect to accessories with the PCL-10168 shielded cable.

Note:

The PCL-10168 shielded cable is especially designed for the PCI-1710/1710L/1710HG/1710HGL/1711/1711L/1716/1716L to reduce noise in the analog signal lines. Please refer to *1.4 Accessories*.

Pin Assignment

Fig. 3-1 shows the pin assignments for the 68-pin I/O connector on the PCI-1710/1710L/1710HG/1710HGL/1711/1711L/1716/ 1716L.

Note:

The three ground references AIGND, AOGND, and DGND should be used discreetly each according to its designated purpose. Actually, we offer the individual GND pin for AI, AO and DIO to provide best signal quality. However, all the signals on the DA&C card need to refer to the same GND finally. So we test and choice a best point to connect AIGND, AOGND and DGND together. In short, this is base on the "single-point" ground principle.

AI0	68	34	AI1
AI2	67	33	AI3
AI4	66	32	AI5
AI6	65	31	AI7
AI8	64	30	AI9
AI10	63	29	AI11
AI12	62	28	AI13
AI14	61	27	AI15
AIGND	60	26	AIGND
DA0_REF	59	25	DA1_REF
DA0_OUT	58	24	DA1_OUT
AOGND	57	23	AOGND
DI0	56	22	DI1
DI2	55	21	DI3
DI4	54	20	DI5
DI6	53	19	DI7
DI8	52	18	DI9
DI10	51	17	DI11
DI12	50	16	DI13
DI14	49	15	DI15
DGND	48	14	DGND
DO0	47	13	DO1
DO2	46	12	DO3
DO4	45	11	DO5
DO6	44	10	DO7
DO8	43	9	DO9
DO10	42	8	DO11
DO12	41	7	DO13
DO14	40	6	DO15
DGND	39	5	DGND
CNT0_CLK	38	4	PACER_OUT
CNT0_OUT	37	3	TRG_GATE
CNT0_GATE	36	2	EXT_TRG
+12V	35	1	+5V

Fig. 3-1 I/O connector pin assignments for the PCI-1710/1710L/1710HG/1710HGL/1711/1711L/1716/1716L

*: Pins 23~25 and pins 57~59 are not defined for PCI-1710L/1710HGL/1711L/1716L

I/O Connector Signal Description

Table 3-1 I/O Connector Signal Description

Signal Name	Reference	Direction	Description
AI<0...15>	AIGND	Input	Analog Input Channels 0 through 15. Each channel pair, AI<i, i+1> (i = 0, 2, 4...14), can be configured as either two single-ended inputs or one differential input.
AIGND	-	-	Analog Input Ground. The three ground references (AIGND, AOGND, and DGND) are connected together on the PCI-1710/1710L/1710HG/1710HGL card.
A00_REF A01_REF	AOGND	Input	Analog Output Channel 0/1 External Reference.
A00_OUT A01_OUT	AOGND	Output	Analog Output Channels 0/1.
AOGND	-	-	Analog Output Ground. The analog output voltages are referenced to these nodes. The three ground references (AIGND, AOGND, and DGND) are connected together on the PCI-1710/1710L/1710HG/1710HGL card.
DI<0...15>	DGND	Input	Digital Input channels.
DO<0...15>	DGND	Output	Digital Output channels.
DGND	-	-	Digital Ground. This pin supplies the reference for the digital channels at the I/O connector as well as the +5VDC supply. The three ground references (AIGND, AOGND, and DGND) are connected together on the PCI-1710/1710L/1710HG/1710HGL card.
CNT0_CLK	DGND	Input	Counter 0 Clock Input. The clock input of counter 0 can be either external (up to 10 MHz) or internal (1 MHz), as set by software.
CNT0_OUT	DGND	Output	Counter 0 Output.
CNT0_GATE	DGND	Input	Counter 0 Gate Control.
PACER_OUT	DGND	Output	Pacer Clock Output. This pin pulses once for each pacer clock when turned on. If A/D conversion is in the pacer trigger mode, users can use this signal as a synchronous signal for other applications. A low - to- high edge triggers A/D conversion to start.
TRG_GATE	DGND	Input	A/D External Trigger Gate. When TRG_GATE is connected to +5 V, it will enable the external trigger signal to input. When TRG_GATE is connected to DGND, it will disable the external trigger signal to input.
EXT_TRG	DGND	Input	A/D External Trigger. This pin is external trigger signal input for the A/D conversion. A low -to-high edge triggers A/D conversion to start.
+12V	DGND	Output	+12 VDC Source.
+5V	DGND	Output	+5 VDC Source.

3.3 Analog Input Connections

The PCI-1710/1710L/1710HG/1710HGL/1716/1716L supports both 16-channel Single-Ended or 8 differential A/D Input, however the PCI-1711/1711L only supports 16 single-ended analog inputs. Each individual input channel is software-selected.

Single-ended Channel Connections

The single-ended input configuration has only one signal wire for each channel, and the measured voltage (V_m) is the voltage of the wire as referenced against the common ground.

A signal source without a local ground is also called a “floating source”. It is fairly simple to connect a single-ended channel to a floating signal source. In this mode, the PCI-1710/1710L/1710HG/1710HGL/1711/1711L/1716/1716L provides a reference ground for external floating signal sources. *Fig. 3-2* shows a single-ended channel connection between a floating signal source and an input channel on the PCI-1710/1710L/1710HG/1710HGL/1711/1711L/1716/1716L.

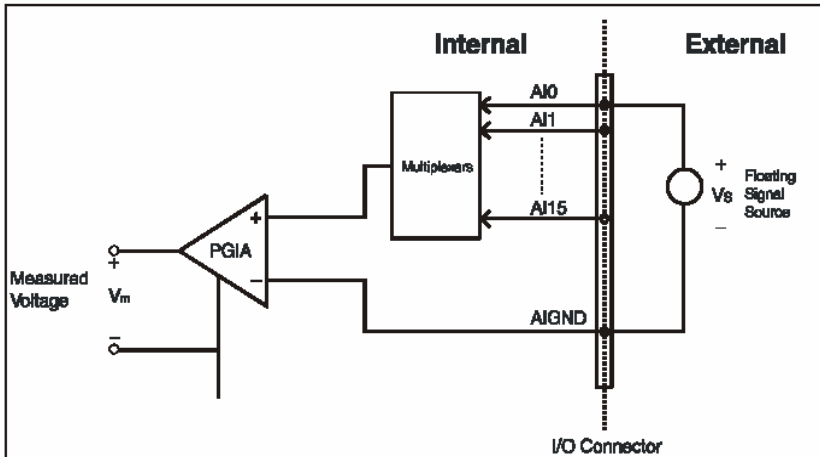

Fig. 3-2 Single-ended input channel connection

Differential Channel Connections

The differential input channels operate with two signal wires for each channel, and the voltage difference between both signal wires is measured. On the PCI-1710/1710L/1710HG/1710HGL/1716/1716L, when all channels are configured to differential input, up to 8 analog channels are available.

If one side of the signal source is connected to a local ground, the signal source is ground-referenced. Therefore, the ground of the signal source and the ground of the card will not be exactly of the same voltage. The difference between the ground voltages forms a common-mode voltage (V_{cm}).

To avoid the ground loop noise effect caused by common-mode voltages, you can connect the signal ground to the Low input. *Fig. 3-3* shows a differential channel connection between a ground-reference signal source and an input channel on the PCI-1710/1710L/1710HG/1710HGL/1716/1716L. With this connection, the PGIA rejects a common-mode voltage V_{cm} between the signal source and the PCI-1710/1710L/1710HG/1710HGL/1716/1716L ground, shown as V_{cm} in *Fig. 3-3*.

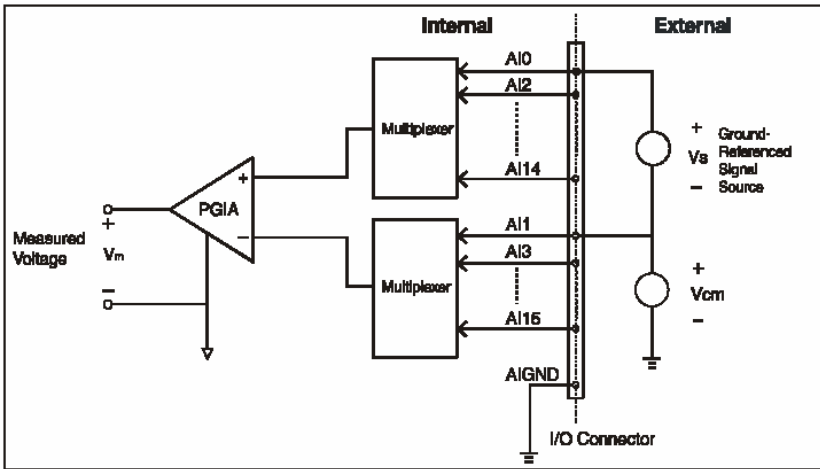

Fig. 3-3 Differential input channel connection - ground reference signal source

If a floating signal source is connected to the differential input channel, the signal source might exceed the common-mode signal range of the PGIA, and the PGIA will be saturated with erroneous voltage-readings. You must therefore reference the signal source

against the AIGND.

Fig. 3-4 shows a differential channel connection between a floating signal source and an input channel on the PCI-1710/1710L/1710HG/1710HGL/1716/1716L. In this figure, each side of the floating signal source is connected through a resistor to the AIGND. This connection can reject the common-mode voltage between the signal source and the PCI-1710/1710L/1710HG/1710HGL/1716/1716L ground.

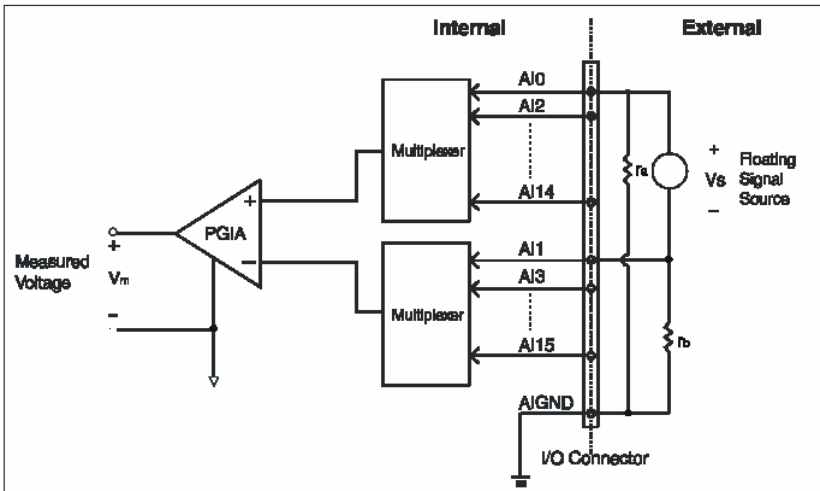
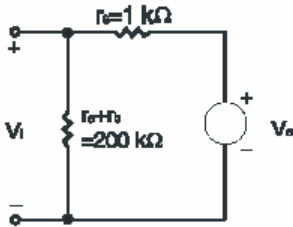

Fig. 3-4 Differential input channel connection - floating signal source

However, this connection has the disadvantage of loading the source down with the series combination (sum) of the two resistors. For r_a

and r_b , for example, if the input impedance r_s is 1 kW, and each of the two resistors is 100 kW, then the resistors load down the signal source with 200 kW ($100 \text{ kW} + 100 \text{ kW}$), resulting in a -0.5% gain error. The following gives a simplified representation of the circuit and calculating process.



- V_s : ideal signal source
- V_i : measured signal sources
- r_s : output impedance of signal source
- r_s, r_b : series-wound resistors

$$V_i = \frac{r_s + r_b}{r_s + r_s + r_b} V_s = \frac{200}{1 + 200} V_s = \frac{200}{201} V_s$$

$$\text{Gain error} = \frac{V_i - V_s}{V_s} = -\frac{1}{201} = -0.5\%$$

3.4 Analog Output Connections

The PCI-1710/1710HG/1711/1716 provides two D/A output channels (PCI-1710L/1710HGL/1711L/1716L are not designed to have this function), **AO0_OUT** and **AO1_OUT**. Users may use the PCI-1710/1710HG/1711/1716 internally-provided precision -5V (-10V) reference to generate 0 to +5 V (+10 V) D/A output range. Users also may create D/A output range through external references, **AO0_REF** and **AO1_REF**. The external reference input range is +/-10 V. For example, connecting with an external reference of -7 V will generate 0 ~ +7 V D/A output.

Fig. 3-5 shows how to make analog output and external reference input connections on the PCI-1710/1710HG/1711/1716.

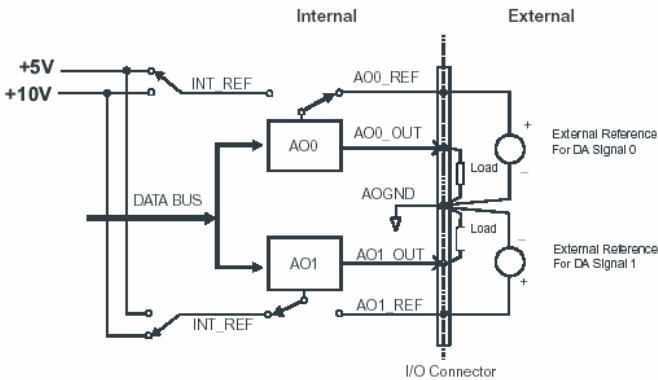

Fig. 3-5 Analog output connections

3.5 Trigger Source Connections

Internal Pacer Trigger Connection

The PCI-1710/1710L/1710HG/1710HGL/1711/1711L/1716/1716L includes one 82C54 compatible programmable Timer/Counter chip which provides three 16-bit counters connected to a 10 MHz clock, each designated specifically as Counter 0, Counter 1 and Counter 2. Counter 0 is a counter which counts events from an input channel or outputting pulse. Counter 1 and Counter 2 are cascaded to create a 32-bit timer for pacer triggering. A low-to-high edge from the Counter 2 output (**PACER_OUT**) will trigger an A/D conversion on the PCI-1710/1710L/1710HG/1710HGL/1711/1711L/1716/1716L. At the same time, you can also use this signal as a synchronous signal for other applications.

External Trigger Source Connection

In addition to pacer triggering, the PCI-1710/1710L/1710HG/1710HGL/1711/1711L/1716/1716L also allows external triggering for A/D conversions. When a +5 V source is connected to **TRG_GATE**, the external trigger function is enabled. A low-to-high edge coming from **EXT_TRG** will trigger an A/D conversion on the PCI-1710/1710L/1710HG/1710HGL/1711/1711L/1716/1716L. When **DGND** is connected to **TRG_GATE**, the external trigger function is thereby disabled.

3.6 Field Wiring Considerations

When you use the PCI-1710/1710L/1710HG/1710HGL/1711/1711L/1716/1716L to acquire data from outside, noises in the environment might significantly affect the accuracy of your measurements if due cautions are not taken. The following measures will be helpful to reduce possible interference running signal wires between signal sources and the PCI-1710/1710L/1710HG/1710HGL/1711/1711L/1716/1716L.

- ♦ The signal cables must be kept away from strong electromagnetic sources such as power lines, large electric motors, circuit breakers or welding machines, since they may cause strong electromagnetic interference. Keep the analog signal cables away from any video monitor, since it can significantly affect a data acquisition system.
- ♦ If the cable travels through an area with significant electromagnetic interference, you should adopt individually shielded, twisted-pair wires as the analog input cable. This type of cable has its signal wires twisted together and shielded with a metal mesh. The metal mesh should only be connected to one point at the signal source ground.
- ♦ Avoid running the signal cables through any conduit that might have power lines in it.
- ♦ If you have to place your signal cable parallel to a power line that has a high voltage or high current running through it, try to keep a safe distance between them. Or, you should place the

signal cable at a right angle to the power line to minimize the undesirable effect.

- ◆ The signals transmitted on the cable will be directly affected by the quality of the cable. In order to ensure better signal quality, we recommend that you use the PCL-10168 shielded cable.

(This page is left blank for hard printing.)

CHAPTER

4

Software Overview

(This page is left blank for hard printing.)

4. Software Overview

This chapter gives you an overview of the software programming choices available and a quick reference to source codes examples that can help you be better oriented to programming. After following the instructions given in *Chapter 2*, it is hoped that you feel comfortable enough to proceed further.

Programming choices for DAS cards: You may use Advantech application software such as Advantech DLL driver. On the other hand, advanced users are allowed another option for register-level programming, although not recommended due to its laborious and time-consuming nature.

4.1 Programming Choices

DLL Driver

The Advantech DLL Drivers software is included on the companion CD-ROM at no extra charge. It also comes with all the Advantech DAS cards. Advantech's DLL driver features a complete I/O function library to help boost your application performance. The Advantech DLL driver for *Windows 95/98/NT/2000/XP* works seamlessly with development tools such as Visual C++, Visual Basic, Borland C++ Builder and Borland Delphi.

Register-level Programming

Register-level programming is reserved for experienced programmers who find it necessary to write codes directly at the level of device registers. Since register-level programming requires much effort and time, we recommend that you use the Advantech DLL drivers instead. However, if register-level programming is indispensable, you should refer to the relevant information in *Appendix C, Register Structure and Format*, or to the example codes included on the companion CD-ROM.

4.2 DLL Driver Programming Roadmap

This section will provide you a roadmap to demonstrate how to build an application from scratch using Advantech DLL driver with your favorite development tools such as Visual C++, Visual Basic, Delphi and C++ Builder. The step-by-step instructions on how to build your own applications using each development tool will be given in the *DLL Drivers Manual*. Moreover, a rich set of example source codes are also given for your reference.

Programming Tools

Programmers can develop application programs with their favorite development tools:

- ◆ **Visual C++**
- ◆ **Visual Basic**
- ◆ **Delphi**
- ◆ **C++ Builder**

For instructions on how to begin programming works in each development tool, Advantech offers a *Tutorial Chapter* in the *DLL Drivers Manual* for your reference. Please refer to the corresponding sections in this chapter on the *DLL Drivers Manual* to begin your programming efforts. You can also take a look at the example source codes provided for each programming tool, since they can get you very well-oriented.

The *DLL Drivers Manual* can be found on the companion CD-ROM. Or if you have already installed the DLL Drivers on your system, The *DLL Drivers Manual* can be readily accessed through the **Start** button:

Start/Programs/Advantech Automation/Device Manager/Device Driver's Manual

The example source codes could be found under the corresponding installation folder such as the default installation path:

\Program Files\ADVANTECH\ADSAPI\Examples

For information about using other function groups or other development tools, please refer to the *Creating Windows 95/98/NT/2000/XP Application with DLL Driver* chapter and the *Function Overview* chapter on the *DLL Drivers Manual*.

Programming with DLL Driver Function Library

Advantech DLL driver offers a rich function library to be utilized in various application programs. This function library consists of numerous APIs that support many development tools, such as Visual C++, Visual Basic, Delphi and C++ Builder.

According to their specific functions or services, those APIs can be categorized into several function groups:

- ◆ **Analog Input Function Group**
- ◆ **Analog Output Function Group**
- ◆ **Digital Input/Output Function Group**
- ◆ **Counter Function Group**
- ◆ **Temperature Measurement Function Group**
- ◆ **Alarm Function Group**
- ◆ **Port Function Group**
- ◆ **Communication Function Group**
- ◆ **Event Function Group**

For the usage and parameters of each function, please refer to the *Function Overview* chapter in the *DLL Drivers Manual*.

Troubleshooting DLL Driver Error

Driver functions will return a status code when they are called to perform a certain task for the application. When a function returns a code that is not zero, it means the function has failed to perform its designated function. To troubleshoot the DLL driver error, you can pass the error code to **DRV_GetErrorMessage** function to return the

error message. Or you can refer to the *DLL Driver Error Codes Appendix* in the *DLL Drivers Manual* for a detailed listing of the Error Code, Error ID and the Error Message.

(This page is left blank for hard printing.)

CHAPTER

5

Calibration

(This page is left blank for hard printing.)

5. Calibration

This chapter provides brief information on PCI-1710/1710L/1710HG/1710HGL/1711/1711L/1716/1716L calibration. Regular calibration checks are important to maintain accuracy in data acquisition and control applications. We provide the calibration programs or utility on the companion CD-ROM to assist you in A/D and D/A calibration.

Note:

If you installed the program to another directory, you can find these programs in the corresponding subfolders in your destination directory.

The PCI-1710/1710L/1710HG/1710HGL/1711/1711L/1716/1716L has been calibrated at the factory for initial use. However, a calibration of the analog input and the analog output function every six months is recommended.

These calibration programs make calibration an easy job. With a variety of prompts and graphic displays, these programs will lead you through the calibration and setup procedures, showing you all the correct settings and adjustments.

To perform a satisfactory calibration, you will need a 4½-digit digital multi-meter and a voltage calibrator or a stable, noise-free DC

voltage source.

Note:

Before you calibrate the A/D or D/A function, you must turn on the power at least **15 minutes** to make sure the DAS card getting stable.

5.1 PCI-1710/1710L/1710HG/1710HGL Calibration

Two calibration programs are included on the companion CD-ROM :

ADCAL.EXE A/D calibration program

DACAL.EXE D/A calibration program

(only for PCI-1710/1710HG)

These calibration programs are designed only for the DOS environment. Access these programs from the default location:

\Program Files\ADVANTECH\ADSAPI\Utilities\PCI1710

VR Assignment

There are five variable resistors (VRs) on the PCI-1710/1710HG card and three variable resistors (VRs) on the PCI-1710L/1710HGL card. These variable resistors are to facilitate accurate adjustments for all A/D and D/A channels. Please refer to the following two figures for the VR positions.

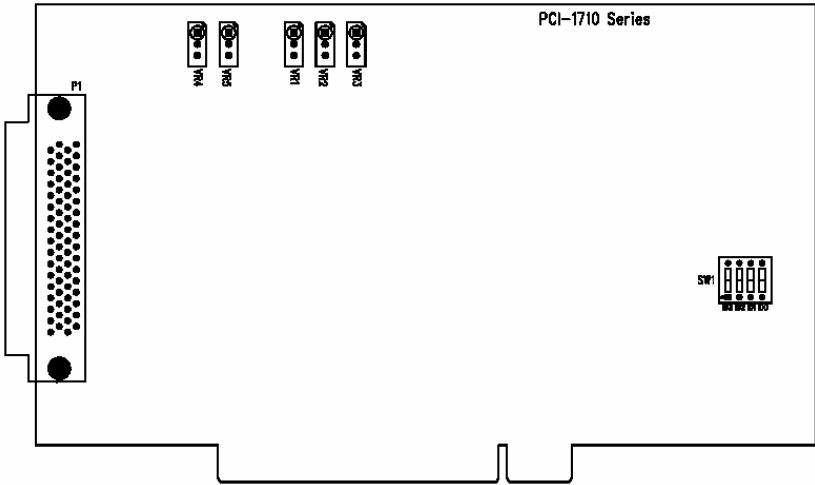

**Fig. 5-1 PCI-1710/1710L/L1710HG/1710HGL
VR assignment**

The following list shows the function of each VR :

VR	Function
VR1	A/D unipolar offset adjustment
VR2	A/D bipolar offset adjustment
VR3	A/D full scale (gain) adjustment
VR4	D/A channel 0 full scale adjustment (for PCI-1710/1710HG only)
VR5	D/A channel 1 full scale adjustment (for PCI-1710/1710HG only)

A/D Calibration

Regular and accurate calibration procedures ensure the maximum possible accuracy. The ADCAL.EXE calibration program leads you through the whole A/D offset and gain adjustment procedure. The basic steps are outlined below:

1. Set analog input channel AI0 as single-ended, bipolar, range ± 5 V, and set AI1 as single-ended, unipolar, range 0 to 10 V.
2. Connect a DC voltage source with value equal to 0.5 LSB (-4.9959 V) to AI0.
3. Adjust VR2 until the output codes from the card's AI0 flickers between 0 and 1.
4. Connect a DC voltage source with a value of 4094.5 LSB (4.9953 V) to AI0.
5. Adjust VR3 until the output codes from the card's AI0 flickers between 4094 and 4095.
6. Repeat step 2 to step 5, adjusting VR2 and VR3.
7. Connect a DC voltage source with value equal to 0.5 LSB (1.22 mV) to AI1.
8. Adjust VR1 until the output codes from the card's AI1 flickers between 0 and 1.

A/D code		Mapping Voltage	
Hex.	Dec.	Bipolar ± 5 V	Unipolar 0 to 10V
000h	0	-4.9971 V	0 V
7FFh	2047	-0.0024 V	4.9947 V
800h	2048	0 V	4.9971 V
FFFh	4095	4.9947 V	9.9918 V

D/A Calibration (for PCI-1710/1710HG only)

In a way similar to the ADCAL.EXE program, the DACAL.EXE program leads you through the whole D/A calibration procedure.

You can either use the on-board -5 V (-10 V) internal reference voltage or use an external reference. If you use an external reference, connect a reference voltage within the range ± 10 V to the reference input of the D/A output channel you want to calibrate. Adjust the full scale (gain) of D/A channel 0 and 1, with VR4 and VR5 respectively.

Note:

Using a precision voltmeter to calibrate the D/A outputs is recommended.

Set the D/A data register to 4095 and adjust VR3 until the D/A output voltage equals the reference voltage minus 1 LSB, but with the opposite sign. For example, if V_{ref} is -5 V, then V_{out} should be +4.9959 V. If V_{ref} is -10 V, V_{out} should be +9.9918 V.

Self A/D Calibration

Under many conditions, it is difficult to find a good enough DC voltage source for A/D calibration. There is a simple method to solve this problem. First, you should calibrate D/A channel 0, DA0_OUT, with internal reference -5 V, and D/A channel 1, DA1_OUT, with reference -10 V.

Then, run the ADCAL.EXE program to finish the self-A/D calibration procedure.

1. Set AI0 as differential, bipolar, range ± 5 V and AI2 as differential, unipolar, range 0 to 10 V.
2. Connect DA0_OUT with codes equal to 4095 LSB (4.9959 V) to AI 0. Notice that the polarity of AI0 should be connected with reverse polarity (i.e. D/A + to A/D -, D/A - to A/D +).
3. Adjust VR2 until the output codes from the card's AI0 flicker between 0 and 1.
4. Connect DA0_OUT with codes equal to 4095 LSB (4.9959 V) to AI0.
5. Adjust VR3 until the output codes from the card's AI0 flickers between 4094 and 4095.
6. Repeat steps 2 through 5, adjusting VR2 and VR3.
7. Connect DA1_OUT with codes equal to 1 LSB (2.44 mV) to AI2.
8. Adjust VR1 until the output codes from the card's AI1 flicker between 0 and 1.
9. Finish ADCAL.EXE.

5.2 PCI-1711/1711L Calibration

Three calibration programs are included on the companion CD-ROM :

ADCAL.EXE **A/D calibration program**

DACAL.EXE **D/A calibration program**

(only for PCI-1711)

SELFCAL.EXE **D/A self-calibration program**

(only for PCI-1711)

These calibration programs are designed only for the DOS environment. Access these programs from the default location:

|Program Files|ADVANTECH|ADSAPI|Utilities|PCI1711

VR Assignment

There are four variable resistors (VRs) on the PCI-1711 card and two variable resistors (VRs) on the PCI-171L card. These variable resistors are to facilitate accurate adjustments for all A/D and D/A channels. Please refer to the following two figures for the VR positions.

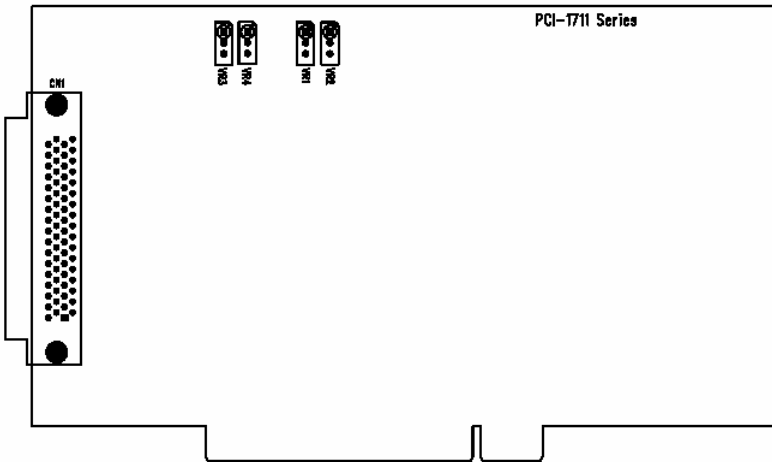

Fig. 5-2 PCI-1711/1711L VR assignment

The following list shows the function of each VR :

VR	Function
VR1	A/D bipolar offset adjustment
VR2	A/D full scale (gain) adjustment
VR3	D/A channel 0 full scale adjustment (for PCI-1711 only)
VR4	D/A channel 1 full scale adjustment (for PCI-1711 only)

A/D Calibration

Regular and accurate calibration procedures ensure the maximum possible accuracy. The A/D calibration program ADCAL.EXE leads you through the whole A/D offset and gain adjustment procedure.

The basic steps are outlined below:

1. Connect a DC voltage source of +9.995 V to AI0.
2. Connect AGND to AI1, AI2, AI3, AI4 and AI5.
3. Run the ADCAL.EXE program.
4. Adjust VR2 until the output codes from the card's AI0 are focused on FFE (at least 70%), and adjust VR1 until the output codes from the card's AI1, AI2, AI3, AI4 and AI5 are focused on 7FF (at least 70%).
5. Press the SPACE key to finish A/D calibration.

D/A Calibration (for PCI-1711 only)

The D/A calibration program DACAL.EXE leads you through the whole D/A calibration procedure.

You can select the on-board -5V or -10V internal reference voltage or an external voltage as your analog output reference voltage. If you use an external reference, connect a reference voltage within the range of $\pm 10\text{V}$ to the reference input of the D/A output channel you want to calibrate. Adjust the full scale of D/A channel 0 and 1, with VR3 and VR4 respectively.

Note:

Using a precision voltmeter to calibrate the D/A outputs is recommended.

You can adjust VR3 and VR4 until the D/A channel 0 and 1 output voltages approach the reference voltage (at least 1LSB), but with the reverse sign. For example, if V_{ref} is $-5V$, then V_{out} should be $+5V$. If V_{ref} is $-10V$, V_{out} should be $+10V$.

Self A/D Calibration

We know, in most cases, it is difficult to find a good enough DC voltage source for A/D calibration. We provide a self-adjusted A/D calibration program “SELFCAL.EXE” to help solve this problem.

The steps of self-calibration are outlined as below:

1. Connect DA0_OUT to AI0.
2. Connect AGND to AI1, AI2, AI3, AI4 and AI5.
3. Run the SELFCAL.EXE program.
4. First calibrate the D/A channel. Adjust VR3 until the DA0_OUT output voltage approaches $+10V$. Then press the **SPACE** key.
5. Next we will do the A/D calibration. Now the DA0_OUT output voltage will be $+9.995V$, then adjust VR2 until the output codes from the card's AI0 focused on FFE (at least 70%) and adjust VR1 until the output codes from the card's AI1, AI2, AI3, AI4 and AI5 focused on 7FF (at least 70%).
6. Press the **SPACE** key to finish calibration procedures.

5.3 PCI-1716/1716L Calibration

A calibration utility, AutoCali, is included on the companion CD-ROM :

AutoCali.EXE PCI-1716/1716L calibration utility

This calibration utility is designed for the Microsoft®Windows™ environment. Access this program from the default location:

\Program Files\ADVANTECH\ADSAPI\Utilities\PCI1716

VR Assignment

There is one variable resistor (VR1) on the PCI-1716/1716L to adjust the accurate reference voltage on the PCI-1716/1716L. We have provided a test point (See TP4 in *Figure 5-3*) for you to check the reference voltage on board. Before you start to calibrate A/D and D/A channels , please adjust VR1 until the reference voltage on TP4 has reached +5.0000 V. *Figure 5-3* shows the locations of VR1 and TP4.

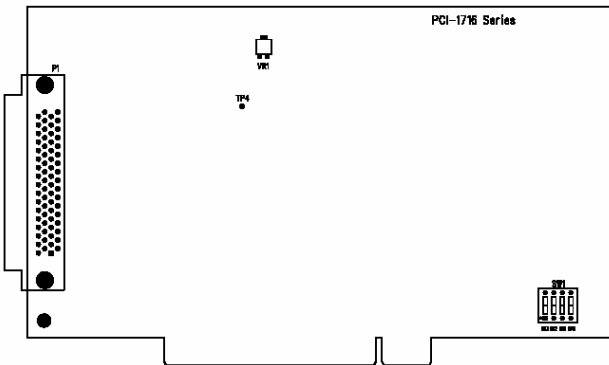

Fig. 5-3 PCI-1716/1716L VR assignment

Calibration Utility

The calibration utility, *AutoCali.EXE*, provides four functions - auto A/D calibration, auto D/A calibration, manual A/D calibration and manual D/A calibration. The program helps the user to easily finish the calibration procedures automatically; however, the user can calibrate the PCI-1716/1716L manually. Appendix E illustrated the standard calibration procedures for your reference. If you want to calibrate the hardware in your own way, these two sections will guide you. The following steps will guide you through the PCI-1716/1716L software calibration.

Step 1: Access the calibration utility program *AutoCali.exe* from the default location:

C: *\Program Files\ADVANTECH\ADSAPI\Utilities\
PCI1716*

Note:

If you installed the program to another directory, you can find this program in the corresponding subfolders in your destination directory.

Step 2: Select PCI-1716/1716L in the ADSDAQ dialog box.

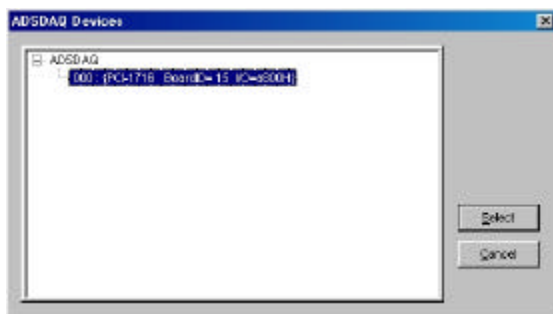

Fig. 5-4 Selecting the device you want to calibrate

Step 3: After you start to calibrate the PCI-1716/1716L, please don't forget to adjust VR1.

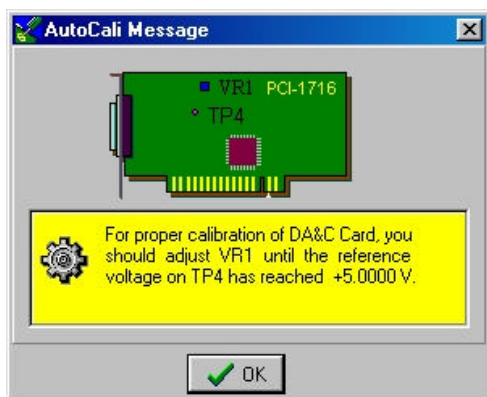

Fig. 5-5 Warning message before start calibration

A/D channel Auto-Calibration

Step 4: Click the *Auto A/D Calibration* tab to show the A/D channel auto-calibration panel (Fig. 5-6). Press the start button to calibrate A/D channels automatically.

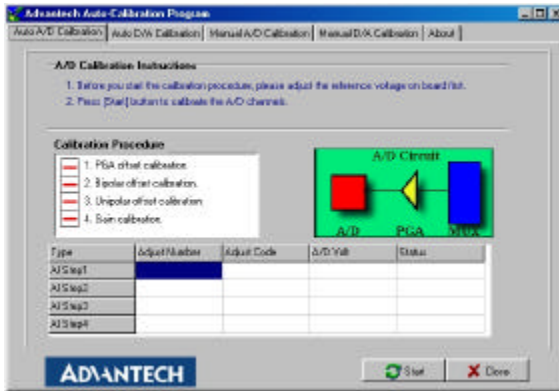

Fig. 5-6 Auto A/D Calibration Dialog Box

Step 5: The first A/D calibration procedure is enabled (Fig. 5-7).

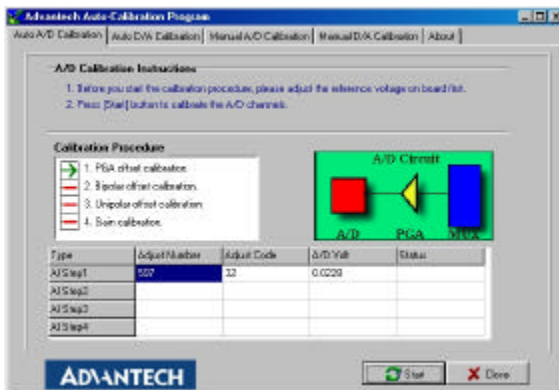

Fig. 5-7 A/D Calibration Procedure 1

Step 6: The second A/D calibration procedure is enabled (Fig. 5-8)

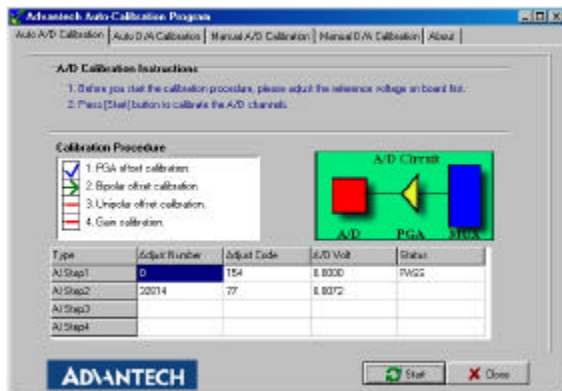

Fig. 5-8 A/D Calibration Procedure 2

Step 7: The third A/D calibration procedure is enabled (Fig. 5-9)

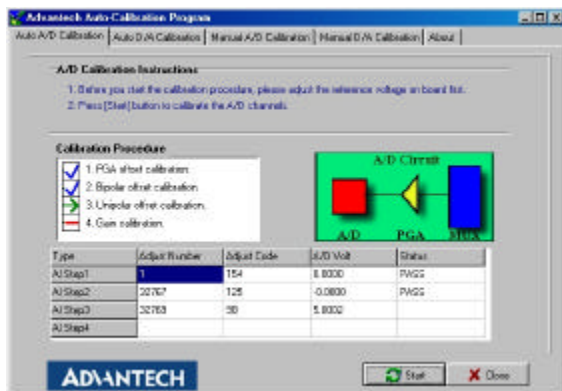

Fig. 5-9 A/D Calibration Procedure 3

Step 8: Auto-calibration is finished. (Fig. 5-10)

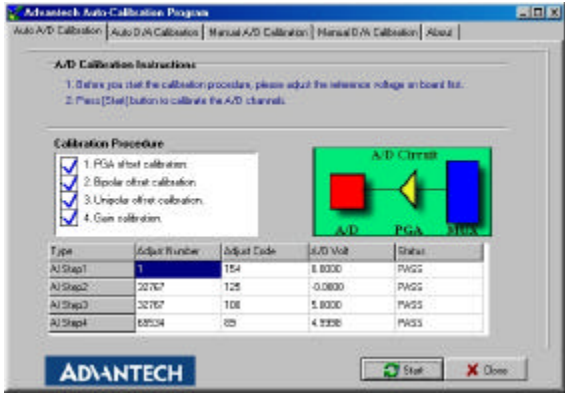

Fig. 5-10 A/D Calibration is finished

D/A channel Auto-Calibration

Step 9: Click the *Auto D/A Calibration* tab to show the D/A channel auto calibration panel. Please finish the A/D calibration procedure first before you start the D/A calibration procedure. There are two D/A channels in PCI-1716; select the output range for each channel and then press the start button to calibrate D/A channels (Fig. 5-11).

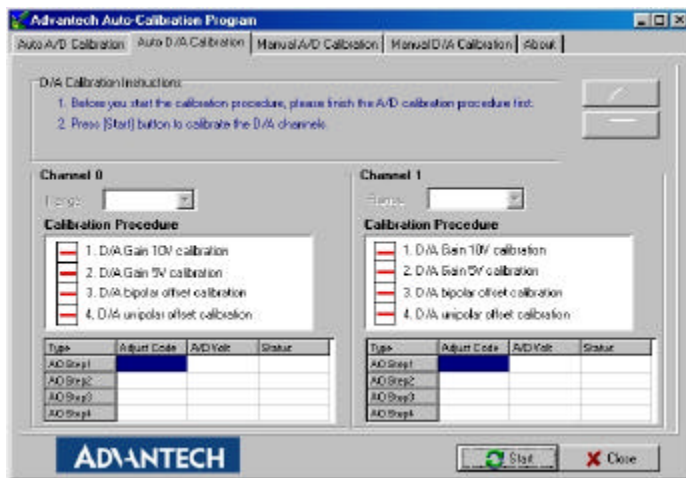

Fig. 5-11 Range Selection in D/A Calibration

Step 10: D/A channel 0 calibration is enabled (Fig. 5-12)

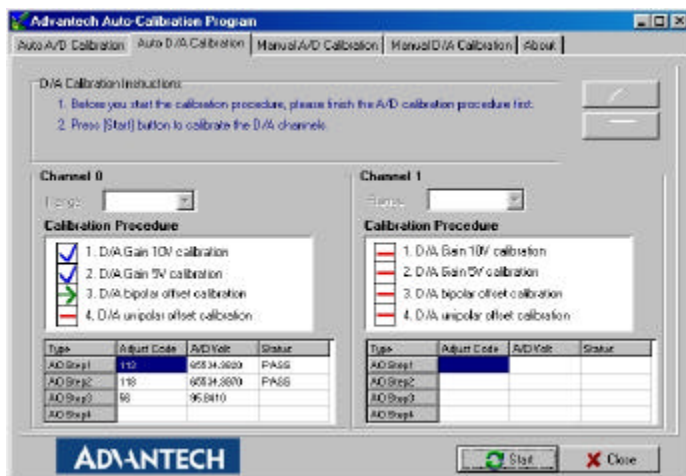

Fig. 5-12 Calibrating D/A Channel 0

Step 11: D/A channel 1 calibration is enabled (Fig. 5-13)

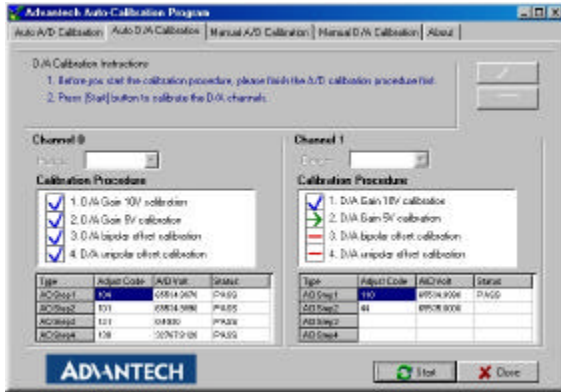

Fig. 5-13 Calibrating D/A Channel 1

Step 12: Auto-calibration is finished (Fig. 5-14)

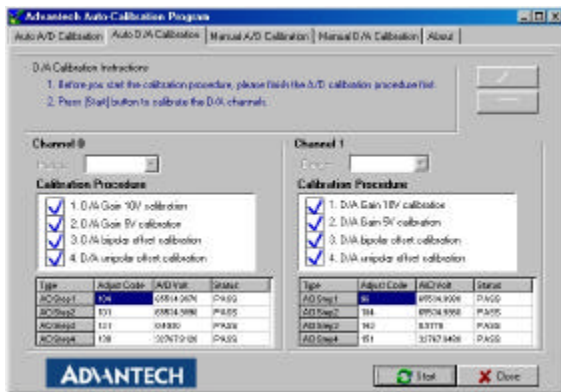

Fig. 5-14 D/A Calibration is finished

A/D channel Manual-Calibration

Step 1: Click the *Manual A/D Calibration* tab to show the A/D channel manual calibration panel. Before calibrating, acquire the reference voltage from a precision standard voltage reference. Go to the **Range** form, select a channel and the target voltage range according to the input voltage value from a precision standard voltage reference (*Fig. 5-15*).

Note:

- The input voltage value you selected from a precision standard voltage reference needs to correspond with the one that the PCI-1716/1716L can read.
 - The input voltage will be analog code so the computer will convert the voltage data into digital code; therefore, the input voltage value you selected from a precision standard voltage reference needs to correspond with the one that the PCI-1716/1716L can read. For example, if the input range is 0 ~ 5V, then input voltage should be 2.9992V not 3V.
-

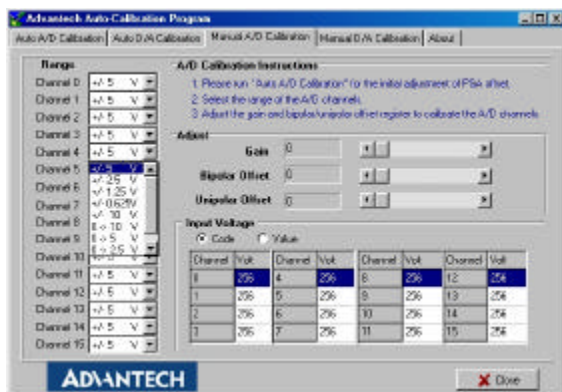

Fig. 5-15 Selecting Input Range in Manual A/D Calibration panel

Step 2: According to the difference between reference voltage and receiving data in PCI-1716/1716L, adjust the gain, bipolar offset and unipolar offset registers (Fig. 5-16)

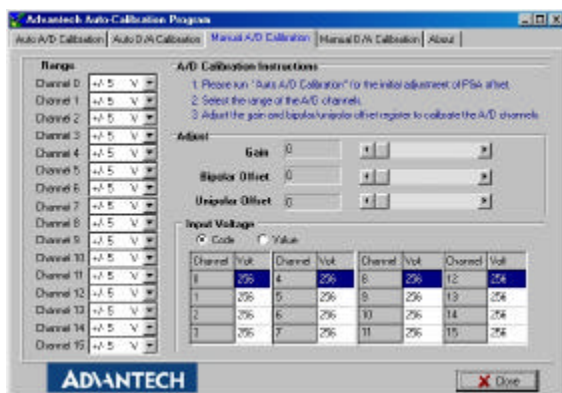

Fig. 5-16 Adjusting registers

Step 3: Adjust the registers until they fall between the input voltage from the standard voltage reference and the receiving voltage reflected in the Manual A/D Calibration tab.

D/A channel Manual-Calibration

Step 1: Click the *Manual D/A Calibration* tab to show the D/A channel manual calibration panel. Two D/A channels are individually calibrated . Before calibrating, output desired voltage from the D/A channels and measure it through an external precision multi-meter.

Step 2: For example, choose channel 0; select the Range and select the wished output voltage code or value from the radio buttons (Fig. 5-17 and Fig. 5-18).

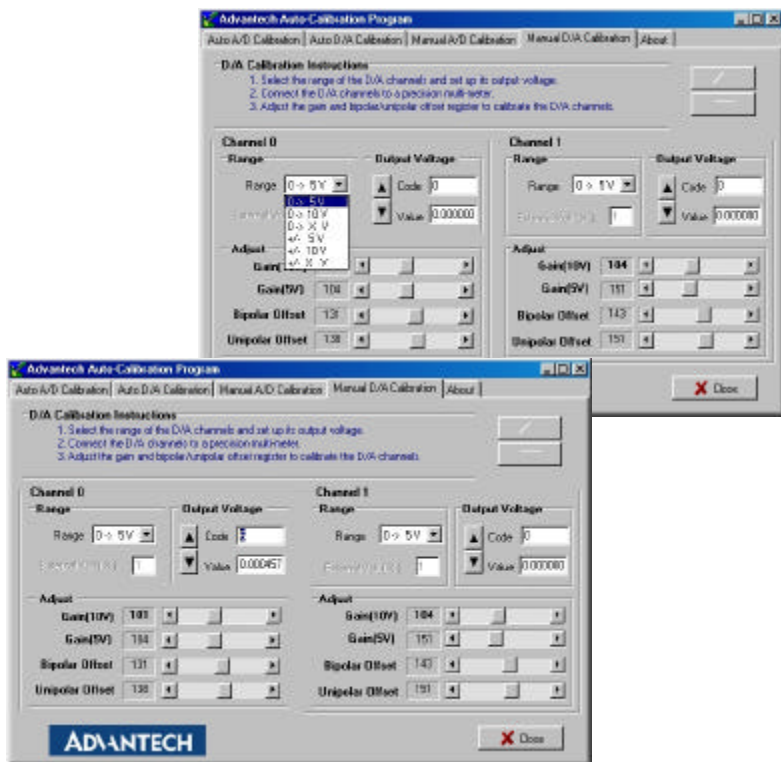

Fig. 5-17 & Fig. 5-18 Selecting D/A Range and Choosing Output Voltage

Step 3: According to the difference between the output voltage from D/A channel and the value in the multi-meter, adjust the gain, bipolar offset and unipolar offset registers (*Fig. 5-19*)

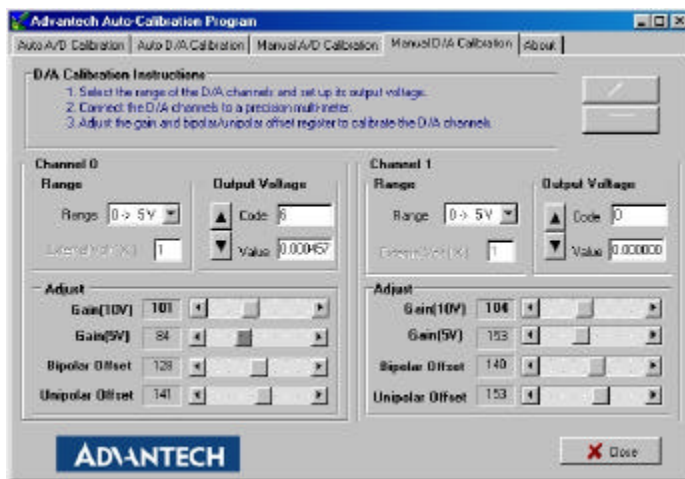

Fig. 5-19 Adjusting registers

Step 4: Adjust registers until they fall between the output voltage from the D/A channel and the value in the multi-meter.

(This page is left blank for hard printing.)

Appendixes

(This page is left blank for hard printing.)

Appendix A. Specifications

A.1 PCI-1710/1710L/1710HG/1710HGL

Analog Input

Channels	16 single-ended or 8 differential or combination																
Resolution	12-bit																
FIFO Size	4k samples																
PCI-1710/1710L Max. Sampling Rate1	100 KS/s																
PCI-1710HG/1710HGL Max. Sampling Rate	Gain	0.5,1		5,10		50,100		500,1000									
	Speed	100 kS/s		35 kS/s		7 kS/s		770 S/s									
Conversion Time	8 μ s																
Input range and Gain List for PCI-1710 / 1710L	Gain	0.5		1		2		4		8							
	Unipolar	N/A		0-10		0-5		0-2.5		0-1.25							
	Bipolar	± 10		± 5		± 2.5		± 1.25		± 0.625							
Input range and Gain List for PCI-1710HG / 1710HGL	Gain	0.5		1		5		10		50		100		500		1000	
	Unipolar	N/A		0-10		N/A		0-1		N/A		0-0.1		N/A		0-0.01	
	Bipolar	± 10		± 5		± 1		± 0.5		± 0.1		± 0.05		± 0.01		± 0.005	
Drift	Gain	1		2		4		8		16							
	Zero (μ V/ $^{\circ}$ C)	15		15		15		15		15							
	Gain (ppm/ $^{\circ}$ C)	25		25		25		30		40							
Small Signal Bandwidth for PGA	Gain	1		2		4		8		16							
	Bandwidth	4.0MHz		2.0MHz		1.5MHz		0.65MHz		0.35MHz							
Common mode voltage	± 11 V max. (operational)																
Max. Input voltage	± 15 V																
Input Impedance	1G Ω / 5 pF																
Trigger Mode	Software, on-board Programmable Pacer or External																
PCI-1710/1710L Accuracy	DC	INLE: ± 1 LSB															
		Monotonicity: 12 bits															
		Offset error: Adjustable to zero															
		Gain	0.5		1		2		4		8						
		Gain error (% FSR)	0.01		0.01		0.02		0.02		0.04						
		Ch Type	S.E./D		S.E./D		D		D		D						
PCI-1710HG/1710HGL Accuracy	DC	SNR: 68 dB															
		ENOB: 11 bits															
		INLE: ± 1 LSB															
		Monotonicity: 12 bits															
		Offset error: Adjustable to zero															
		Gain	0.5,1		5,10		50,100		500		1000						
Gain error (% FSR)	0.01		0.02		0.04		0.08		0.08								
Ch Type	S.E./D		S.E./D		D		D		D								
External TTL Trigger Input	Low High	SNR: 68 dB															
		ENOB: 11 bits															
		0.4 V max.															
		2.4V min.															

Analog Output

Channels	2	
Resolution	12-bit	
Output Range (Internal & External Reference)	Using Internal Reference	0 - +5V, 0 - +10 V
	Using External Reference	0 - + x V @ + x V (-10 x 10)
Accuracy	Relative	±0.5 LSB
	Differential Non-linearity	±0.5 LSB (monotonic)
Gain Error	Adjustable to zero	
Slew Rate	10 V / μ s	
Drift	40 ppm / °C	
Driving Capability	3 mA	
Max. Update Rate	100 K samples /s	
Output Impedance	0.810 (min)	
Digital Rate	5 M Hz	
Settling Time	26 μ s (to ± 1/2 LSB of FSR)	
Reference Voltage	Internal	- 5V - + 5V
	External	- 10V - +10V

Digital Input/Output

Input Channels	16	
Input Voltage	Low	0.4 V max.
	High	2.4V min.
Input Load	Low	0.4 V max. @ - 0.2mA
	High	2.7V min. @ 20 μ A
Output Channels	16	
Output Voltage	Low	0.4 V max. @ + 8.0 mA (sink)
	High	2.4V min. @ - 0.4 mA (source)

Counter/Timer

Channels	3 channels, 2 channels are permanently configured as programmable pacers; 1 channel is free for user application	
Resolution	16-bit	
Compatibility	TTL level	
Base Clock	Channel 2: Takes input from output of channel 1 Channel 1: 1MHz Channel 0: Internal 100kHz or external clock (1 MHz) max Selected by software	
Max. Input Frequency	1 M Hz	
Clock Input	Low	0.8 V max.
	High	2.0 V min.
Gate Input	Low	0.8 V max.
	High	2.0 V min.
Counter Output	Low	0.5 V max. @ +24mA
	High	2.4 V min. @ -15mA

General

I/O Connector Type	68-pin SCSI-II female	
Dimensions	175 mm x 100 mm (6.9" x 3.9")	
Power Consumption	Typical	+ 5 V @ 850mA
	Max.	+ 5 V @ 1 A
Temperature	Operation	0 ~ +60 °C (32~ 158) (refer to IEC 65 - 2 - 1 ,2)
	Storage	-20 ~ +70 °C (-4 ~158)
Relative Humidity	Operation	5 ~ 85% RH non-condensing (refer to IEC 68 -1,-2,-3)
	Storage	5 ~ 95% RH non-condensing (refer to IEC 68 -1,-2,-3)
Certification	CE certified	

A.2 PCI-1711/1711L Specifications

Analog Input

Channels	16 Single-Ended					
Resolution	12-bit					
FIFO Size	1K samples					
Max. Sampling Rate	100 KS/s max.					
Conversion Time	10 μ s					
Input Range and Gain List	Gain	1	2	4	8	16
	Input	$\pm 10V$	$\pm 5V$	$\pm 2.5V$	$\pm 1.25V$	$\pm 0.625V$
Drift (ppm /)	Zero	1	2	4	8	16
	Zero	15	15	15	15	15
	Gain	25	25	25	30	40
Small Signal Bandwidth for PGA	Bandwidth	4.0 M Hz	2.0 M Hz	1.5 M Hz	0.65 M Hz	0.35 M Hz
	Max. Input Overvoltage	$\pm 15V$				
Input Protect	30 Vp-p					
Input Impedance	2 M Ω / 5 pF					
Trigger Mode	Software, On-board Programmable Pacer or external					
Accuracy	DC	INLE: ± 0.5 LSB				
		Monotonicity: 12 bits				
		Offset error : Adjustable to zero				
		Gain error: 0.005% FSR (Gain=1)				
	AC	SNR : 68 dB				
		ENOB: 11 bits				

Analog Output (Only for PCI-1711)

Channels	2	
Resolution	12-bit	
Output Range (Internal & External Reference)	Using Internal Reference	0 ~ +5V, 0 ~ +10 V
	Using External Reference	0 ~ +x V @ +x V (-10 x 10)
Accuracy	Relative	± 0.5 LSB
	Differential Non-linearity	± 0.5 LSB (monotonic)
Gain Error	Adjustable to zero	
Slew Rate	11 V/ μ s	
Drift	40 ppm / $^{\circ}C$	
Driving Capability	3 mA	
Throughput	38 KS/s (min.)	
Output Impedance	0.810	
Settling Time	26 μ s (to $\pm 1/2$ LSB of FSR)	
Reference Voltage	Internal	-5 V or -10 V
	External	-10V ~+10V

Digital Input/Output

Input Channels	16	
Input Voltage	Low	0.4 V max.
	High	2.4V min.
Input Load	Low	0.4 V max. @ -0.2mA
	High	2.7V min. @ 20 μ A
Output Channels	16	
Output Voltage	Low	0.4 V max. @ + 8.0 mA (sink)
	High	2.4V min. @ - 0.4 mA (source)

Programmable Counter/Timer

Channels	3 channels, 2 channels are permanently configured as programmable pacers;1 channel is free for user application	
Resolution	16-bit	
Compatibility	TTL level	
Base Clock	Channel 2:Takes input from output of channel 1 Channel 1:1MHz Channel 0: Internal 1MHz or external clock (10 MHz) max Selected by software	
Max. Input Frequency	10 MHz	
Clock Input	Low	0.8 V max.
	High	2.0 V min.
Gate Input	Low	0.8 V max.
	High	2.0 V min.
Counter Output	Low	0.5 V max. @ +24mA
	High	2.4 V min. @ -15mA

General

I/O Connector Type	68-pin SCSI-II female	
Dimensions	175 mm x 100 mm (6.9" x 3.9")	
Power Consumption	Typical	+ 5 V @ 850mA
	Max.	+ 5 V @ 1 A
Temperature	Operation	0 ~ +60 °C (32~ 158) (refer to IEC 65 - 2 - 1 ,2)
	Storage	-20 ~ +70°C (-4 ~158)
Relative Humidity	Operation	5 ~ 85% RH non-condensing (refer to IEC 68 -1,-2,-3)
	Storage	5 ~ 95% RH non-condensing (refer to IEC 68 -1,-2,-3)
Certification	CE certified	

A.3 PCI-1716/1716L Specifications

Analog Input

Channels	16 Single-Ended or 8 Bridgedifferential or combination					
Resolution	16-bit					
FIFO Size	1K samples					
Max. Sampling Rate	250 KS/s max.					
Conversion Time	2.5 μ s					
Input range and Gain List	Gain	0.5	1	2	4	8
	Unipolar	N/A	0-10	0-5	0-2.5	0-1.2
	Bipolar	\pm 10V	\pm 5V	\pm 2.5V	\pm 1.25V	\pm 0.625V
Small Signal Bandwidth for PGA	Gain	0.5	1	2	4	8
	Bandwidth	4.0 M Hz	4.0 M Hz	2.0 M Hz	1.5 M Hz	0.65 M Hz
Common mode Voltage	\pm 11 V max. (operational)					
Max. Input Voltage	\pm 20V					
Input Protect	30 Vp-p					
Input Impedance	100 MO / 10 pF(Off) ; 100 MO / 10 OpF(On)					
Trigger Mode	Software, On-board Programmable Pacer or external					
Accuracy	DC	INLE: \pm 1 LSB				
		INLE: \pm 1 LSB				
		Zero (Offset) error: Adjustable to \pm 1 LSB				
		Gain	0.5	1	2	4
	Gain error (%FSR)	0.15	0.03	0.03	0.05	0.1
	AC	SNR : 82 dB				
		ENOB: 13.5 bits				
THD: - 84 Db typical						
Clocking and Trigger Inputs	Trigger Mode	Software, on-board programmable pacer or external				
	A/D pacer clock	250 k Hz (max.) ; 58 μ s Hz (min.)				
	External A/D trigger Clock	Min. pulse width: 2 μ s (high); 2 μ s (low) Max. frequency: 250KHz				

Analog Input (Only for PCI-1716)

Channels	2	
Resolution	16-bit	
Operation mode	Single output	
Throughput *	200 KS/s max. per channel (FSR)	
Output Range (Internal & External Reference)	Using Internal Reference	0 ~ +5V, 0 ~ +10V, -5V ~ +5V, -10V ~ +10V
	Using External Reference	0 ~ +x V @ + x V (-10 x 10) -x ~ +x V @ + x V (-10 x 10)
Accuracy	DC	DNLE: ± 1 LSB (monotonic)
		INLE: ± 1 LSB
		Zero (Offset) error: Adjustable to ± 1 LSB
		Gain (Full-scale) error: Adjustable to ± 1 LSB
Dynamic Performance	Setting Time	5 μ s (to 4 LSB of FSR)
	Slew Rate	20 V / μ s
Drift	10 ppm /	
Driving Capability	± 20 mA	
Output Impedance	0.10 max.	

Digital Input/Output

Input Channels	16	
Input Voltage	Low	0.4 V max.
	High	2.4V min.
Input Load	Low	0.4 V max. @ -0.2mA
	High	2.7V min. @ 20 μ A
Output Channels	16	
Output Voltage	Low	0.4 V max. @ + 8.0 mA (sink)
	High	2.4V min. @ - 0.4 mA (source)

Counter/Timer

Channels	3 channels, 2 channels are permanently configured as programmable pacers;1 channel is free for user application	
Resolution	16-bit	
Compatibility	TTL level	
Base Clock	Channel 2:Takes input from output of channel 1 Channel 1:1MHz Channel 0: Internal 1MHz or external clock (10 MHz) max Selected by software	
Max. Input Frequency	1 M Hz	
Clock Input	Low	0.8 V max.
	High	2.0 V min.
Gate Input	Low	0.8 V max.
	High	2.0 V min.
Counter Output	Low	0.5 V max. @ +24mA
	High	2.4 V min. @ -15mA

General

I/O Connector Type	68-pin SCSI-II female	
Dimensions	175 mm x 100 mm (6.9" x 3.9")	
Power Consumption	Typical	+ 5 V @ 850mA + 12V @ 600mA
	Max.	+ 5 V @ 1 A + 12V @ 700mA
Temperature	Operation	0 ~ +60 °C (32~ 158) (refer to IEC 65 – 2 - 1 ,2)
	Storage	-20 ~ +85 °C (-4 ~158)
Relative Humidity	Operation	5 ~ 85% RH non-condensing (refer to IEC 68 -1,-2,-3)
	Storage	5 ~ 95% RH non-condensing (refer to IEC 68 -1,-2,-3)
Certification	CE certified	

Appendix B. Block Diagrams

B.1 Block Diagram of PCI-1710/1710L/1710HG/1710HGL

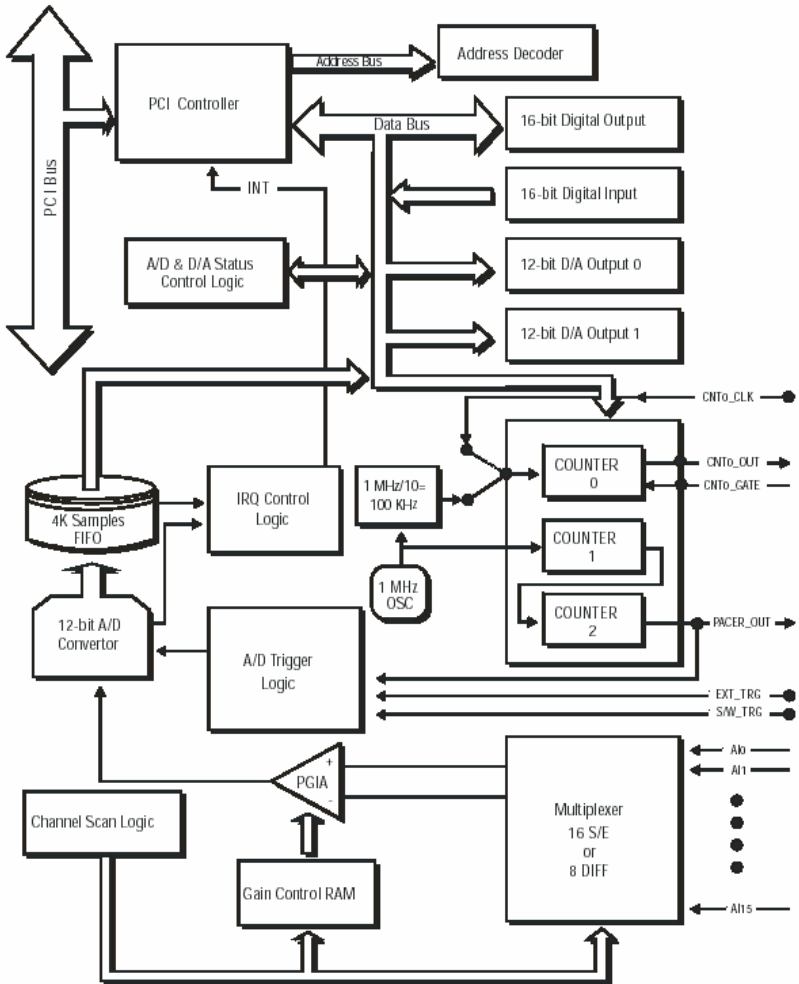

B.2 Block Diagram of PCI-1711/1711L

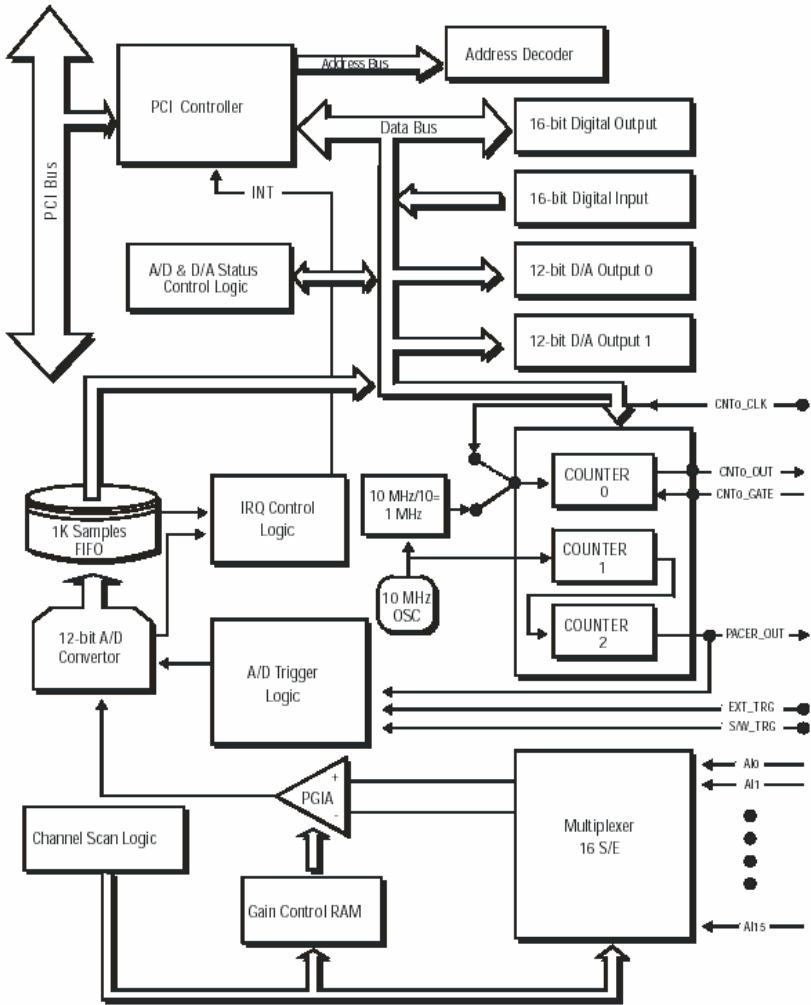

B.3 Block Diagram of PCI-1716/1716L

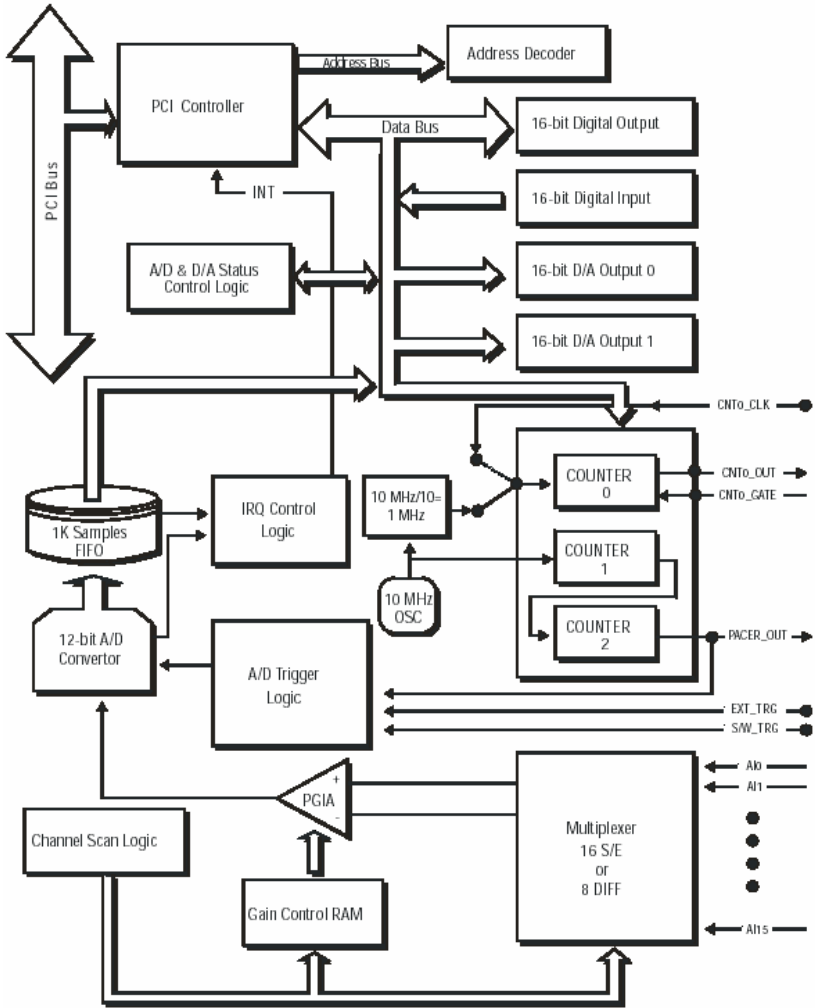

(This page is left blank for hard printing.)

Appendix C. Register Structure and Format

C.1 Overview

The PCI-1710/1710L/1710HG/1710HGL/1711/1711L/1716/1716L is delivered with an easy-to-use 32-bit DLL driver for user programming under the *Windows 95/98/NT/2000/XP* operating system. We advise users to program the PCI-1710/1710L/1710HG/1710HGL/1711/1711L/1716/1716L using the 32-bit DLL driver provided by Advantech to avoid the complexity of low-level programming by register.

The most important consideration in programming the PCI-1710/1710L/1710HG/1710HGL/1711/1711L/1716/1716L at the register level is to understand the function of the card's registers. The information in the following sections is provided only for users who would like to do their own low-level programming.

C.2 I/O Port Address Map

The PCI-1710/1710L/1710HG/1710HGL/1711/1711L/1716/1716L requires 32 consecutive addresses in the PC's I/O space. The address of each register is specified as an offset from the card's base address. For example, BASE+0 is the card's base address and BASE+7 is the base address plus seven bytes.

The *Table C-1* shows the function of each register of the PCI-1710/1710L/1710HG/1710HGL/1711/1711L/1716/1716L or driver and its address relative to the card's base address.

**Table C-1 PCI-1710/1710L/1710HG/1710HGL/1711/1711L
register format (Part 1)**

Base Address +decimal	Read							
	7	6	5	4	3	2	1	0
	Channel Number and A/D Data							
1	CH3	CH2	CH1	CH0	AD11	AD10	AD9	AD8
0	AD7	AD6	AD5	AD4	AD3	AD2	AD1	AD0
	N/A							
3								
2								
	N/A							
5								
4								
	Status Register							
7					IRQ	F/F	F/H	F/E
6		CNT0	ONE/FH	IROEN	GATE	EXT	PACER	SW
	N/A							
9								
8								
	N/A							
11								
10								
	N/A							
13								
12								
	N/A							
15								
14								

Table C-1 PCI-1716/1716L register format (Part 2)

Base Address +decimal	Read							
	7	6	5	4	3	2	1	0
	A/D Data							
1	AD15	AD14	AD13	AD12	AD11	AD10	AD9	AD8
0	AD7	AD6	AD5	AD4	AD3	AD2	AD1	AD0
	N/A							
3								
2								
	N/A							
5								
4								
	A/D Status Register							
7	CAL				IRQ	F/F	F/H	F/E
6	AD16/12	CNT0	ONE/FH	IROEN	GATE	EXT	PACER	SW
	N/A							
9								
8								
	D/A channel 0 data							
11								
10								
	D/A channel 1 data							
13								
12								
	N/A							
15								
14								

**Table C-1 PCI-1710/1710L/1710HG/1710HGL/1711/1711L/
1716/1716L register format (Part 3)**

Base Address +decimal	Read							
	7	6	5	4	3	2	1	0
	Digital Input							
17	DI15	DI14	DI13	DI12	DI11	DI10	DI9	DI8
16	DI7	DI6	DI5	DI4	DI3	DI2	DI1	DI0
	N/A							
19								
18								
	Board ID (only for PCI-1716/1716L)							
21								
20					BD3	BD2	BD1	BD0
	N/A							
23								
22								
	Counter 0							
25								
24	D7	D6	D5	D4	D3	D2	D1	D0
	Counter 1							
27								
26	D7	D6	D5	D4	D3	D2	D1	D0
	Counter 2							
29								
28	D7	D6	D5	D4	D3	D2	D1	D0
	N/A							
31								
30								

**Table C-1 PCI-1710/1710L/1710HG/1710HGL/1711/1711L
register format (Part 4)**

Base Address +decimal	Write							
	7	6	5	4	3	2	1	0
	Software A/D Trigger							
1								
0								
	A/D Channel Range Setting							
3								
2			*S/D	*B/U		G2	G1	G0
	Multiplexer Control							
5					Stop channel			
4					Start channel			
	A/D Control Register							
7								
6		CNT0	ONE/FH	IRQEN	GATE	EXT0	PACER	SW
	Clear Interrupt and FIFO							
9	Clear FIFO							
8	Clear interrupt							
	D/A Output Channel 0							
11					DA11	DA10	DA9	DA8
10	DA7	DA6	DA5	DA4	DA3	DA2	DA1	DA0
	D/A Output Channel 1							
13					DA11	DA10	DA9	DA8
12	DA7	DA6	DA5	DA4	DA3	DA2	DA1	DA0
	D/A Control Register							
15								
14					DA1_I/E	DA1_5/10	DA0/I/E	DA0_5/10

*: S/D, B/U are not supported for PCI-1711/1711L

Table C-1 PCI-1716/1716L register format (Part 5)

Base Address +decimal	Write							
	7	6	5	4	3	2	1	0
	Software A/D Trigger							
1								
0								
	A/D Channel Range Setting							
3								
2			S/D	B/U		G2	G1	G0
	Multiplexer Control							
5					Stop channel			
4					Start channel			
	A/D Control Register							
7	CAL							
6	AD16/12	CNT0	ONE/FH	IRQEN	GATE	EXT0	PACER	SW
	Clear Interrupt and FIFO							
9	Clear FIFO							
8	Clear interrupt							
	D/A Output Channel 0							
11	DA15	DA14	DA13	DA12	DA11	DA10	DA9	DA8
10	DA7	DA6	DA5	DA4	DA3	DA2	DA1	DA0
	D/A Output Channel 1							
13	DA15	DA14	DA13	DA12	DA11	DA10	DA9	DA8
12	DA7	DA6	DA5	DA4	DA3	DA2	DA1	DA0
	D/A Control Register							
15					DA1_LDEN	DA1_I/E	DA0_B/U	DA1_5/10
14					DA0_LDEN	DA0_I/E	DA0_B/U	DA0_5/10

**Table C-1 PCI-1710/1710L/1710HG/1710HGL/1711/1711L/
1716/1716L register format (Part 6)**

Base Address +decimal	Write							
	7	6	5	4	3	2	1	0
	Digital Output							
17	DO15	DO14	DO13	DO12	DO11	DO10	DO9	DO8
16	DO7	DO6	DO5	DO4	DO3	DO2	DO1	DO0
	Calibration Command and Data (only for PCI-1716/1716L)							
19					CM3	CM2	CM1	CM0
18	D7	D6	D5	D4	D3	D2	D1	D0
	N/A							
21								
20								
	N/A							
23								
22								
	Counter 0							
25								
24								
	Counter 1							
27								
26								
	Counter 2							
29								
28								
	Counter Control							
31								
30								

C.3 Channel Number and A/D Data — BASE+0 and BASE+1

BASE+0 and BASE+1 hold the result of A/D conversion data.

For PCI-1710/1710L/1710HG/1710HGL/1711/1711L, the 12 bits of data from the A/D conversion are stored in BASE+1 bit 3 to bit 0 and BASE+0 bit 7 to bit 0. BASE+1 bit 7 to bit 4 hold the source A/D channel number.

**Table C-2 PCI-1710/1710L/1710HG/1710HGL/1711/1711L
Register for channel number and A/D data**

Read	Channel Number and A/D Data							
Bit #	7	6	5	4	3	2	1	0
BASE + 1	CH3	CH2	CH1	CH0	AD11	AD10	AD9	AD8
BASE + 0	AD7	AD6	AD5	AD4	AD3	AD2	AD1	AD0

AD11 ~ AD0

Result of A/D Conversion

AD0 the least significant bit (LSB) of A/D data

AD11 the most significant bit (MSB)

CH3 ~ CH0

A/D Channel Number

CH3 ~ CH0 hold the number of the A/D channel from which the data is received

CH3 MSB

CH0 LSB

For PCI-1716/1716L, the 16 bits of data from the A/D conversion are stored in BASE+1 bit 7 to bit 0 and BASE+0 bit 7 to bit 0.

Table C-3 PCI-1716/1716L Register for A/D data

Read	A/D Data							
Bit #	7	6	5	4	3	2	1	0
BASE + 1	AD15	AD14	AD13	AD12	AD11	AD10	AD9	AD8
BASE + 0	AD7	AD6	AD5	AD4	AD3	AD2	AD1	AD0

AD15 ~ AD0

Result of A/D Conversion

AD0 the least significant bit (LSB) of A/D data

AD15 the most significant bit (MSB)

C.4 Software A/D Trigger — BASE+0

You can trigger an A/D conversion by software, the card's on-board pacer or an external pulse.

BASE+6, Bit 2 to bit 0, select the trigger source.

(see *Section C.7, Control Register -- BASE+6*)

If you select software triggering, a write to the register BASE+0 with any value will trigger an A/D conversion.

C.5 A/D Channel Range Setting — BASE+2

Each A/D channel has its own input range, controlled by a gain code stored in the on-board RAM.

To change the range code for a channel:

- ? Write the same channel in BASE+4 (the start channel) and BASE+5 (the stop channel) (refer to *Section C.6*).
- ? Write the gain code to BASE+2 bit 0 to bit 2.

Table C-4 Register for A/D channel range setting

Write	A/D Channel Range Setting							
Bit #	7	6	5	4	3	2	1	0
BASE + 2			*S/D	*B/U		G2	G1	G0

*: S/D, B/U are not supported for PCI-1711/1711L

S/D Single-ended or Differential

0 single-ended

1 differential.

B/U Bipolar or Unipolar

0 bipolar

1 unipolar.

G2 to G0 Gain Code

Table C-5 lists the gain codes for the PCI-1710/1710L.

Table C-6 lists the gain codes for the PCI-1710HG/1710HGL.

Table C-7 lists the gain codes for the
PCI-1711/1711L.

Table C-5 Gain codes for PCI-1710/1710L

PCI-1710/1710L					
Gain	Input Range(V)	B/U	Gain Code		
			G2	G1	G0
1	-5 to +5	0	0	0	0
2	-2.5 to +2.5	0	0	0	1
4	-1.25 to +1.25	0	0	1	0
8	-0.625 to +0.625	0	0	1	1
0.5	-10 to +10	0	1	0	0
	N/A	0	1	0	1
	N/A	0	1	1	0
	N/A	0	1	1	1
1	0 to 10	1	0	0	0
2	0 to 5	1	0	0	1
4	0 to 2.5	1	0	1	0
8	0 to 1.25	1	0	1	1
	N/A	1	1	0	0
	N/A	1	1	0	1
	N/A	1	1	1	0
	N/A	1	1	1	1

Table C-6 Gain codes for PCI-1710HG/1710HGL

PCI-1710HG/1710HGL					
Gain	Input Range(V)	B/U	Gain Code		
			G2	G1	G0
1	-5 to +5	0	0	0	0
10	-0.5 to +0.5	0	0	0	1
100	-0.05 to +0.05	0	0	1	0
1000	-0.005 to +0.005	0	0	1	1
0.5	-10 to +10	0	1	0	0
5	-1 to +1	0	1	0	1
50	-0.1 to +0.1	0	1	1	0
500	-0.01 to +0.01	0	1	1	1
1	0 to 10	1	0	0	0
10	0 to 1	1	0	0	1
100	0 to 0.1	1	0	1	0
1000	0 to 0.01	1	0	1	1
	N/A	1	1	0	0
	N/A	1	1	0	1
	N/A	1	1	1	0
	N/A	1	1	1	1

Table C-7 Gain codes for PCI-1711/1711L

PCI-1711/1711L				
Gain	Input Range(V)	Gain Code		
		G2	G1	G0
1	-10 to +10	0	0	0
2	-5 to +5	0	0	1
4	-2.5 to +2.5	0	1	0
8	-1.25 to +1.25	0	1	1
16	-0.625 to +0.625	1	0	0

Example: To set channel 3 as gain=1

1. Write channel 3 to BASE+4 as 00000011.
2. Write channel 3 to BASE+5 as 00000011.
3. Refer to the gain code list, write gain=1 to BASE+2 as 00000000.

C.6 MUX Control — BASE+4 and BASE+5

Table C-8 Register for multiplexer control

Write	Multiplexer Control							
Bit #	7	6	5	4	3	2	1	0
BASE + 5					STO3	STO2	STO1	STO0
BASE + 4					STA3	STA2	STA1	STA0

STA3 ~ STA0 Start Scan Channel Number

STO3 ~ STO0 Stop Scan Channel Number

- When you set the gain code of analog input channel n, you should set the Multiplexer start & stop channel number to channel n to prevent any unexpected errors. In fact BASE+4 bit 3 to bit 0, STA3 ~ STA0, act as a pointer to channel n' s address in the SRAM when you program the A/D channel setting (*refer to Section C.5*).

Caution!

We recommend you to set the same start and stop channel when writing to the register BASE+2. Otherwise, if the A/D trigger source is on, the multiplexer will continuously scan between channels and the range setting may be set to an unexpected channel. Make sure the A/D trigger source is turned off to avoid this kind of error.

The write-only registers of BASE +4 and BASE+5 control how the multiplexers (Multiplexer) scan.

- ? BASE+4 bit 3 to bit 0, STA3 ~ STA0, hold the start scan channel number.
- ? BASE+5 bit 3 to bit 0, STO3 ~ STO0, hold the stop scan channel number.

Writing to these two registers automatically initializes the scan range of the Multiplexer. Each A/D conversion trigger also sets the Multiplexer to the next channel. With continuous triggering, the Multiplexer will scan from the start channel to the stop channel and then repeat. The following examples show the scan sequences of the Multiplexer.

Example 1

If the start scan input channel is AI3 and the stop scan input channel is AI7, then the scan sequence is AI3, AI4, AI5, AI6, AI7, AI3, AI4, AI5, AI6, AI7, AI3, AI4...

Example 2

If the start scan channel is AI13 and the stop scan channel is AI2, then the scan sequence is AI13, AI14, AI15, AI0, AI1, AI2, AI13, AI14, AI15, AI0, AI1, AI2, AI13, AI14...

The scan logic of the PCI-1710/1710L/1710HG/1710HGL/1716/1716L card is powerful and easily understood. You can set the gain code, B/U and S/D, for each channel. For the Analog Input function, we set two AI channel AI<i, i+1> (i= 0, 2, 4, ...,14) work as a pair.

For example, the AI0 and AI1 is a pair. When in single-ended mode, we can get data from AI0 and AI1 separately. But if we set them as differential mode, the results polling AI0 and AI1 will be the same. That is if we set the AI0 and AI1 as a differential input channel, we can get the correct result no matter we polling channel 0 or channel 1.

But if we want to use the multiple channels input function, the things will be a little bit different. If we set two AI channel as a differential channel, it will be take as one channel in the data array. Since the resulted data array of the multi-channel scan function is ranked with the order of channel, let us give a example to make it more clear. Now we set channel 0, 1 as differential and 2, 3 as single ended and then 4,5 as differential mode. And we set the start channel as channel 0 and number of channel as 4, the result will be

```
##.#### -> channel 0,1
##.#### -> channel 2
##.#### -> channel 3
##.#### -> channel 4,5
##.#### -> channel 0,1
##.#### -> channel 2
##.#### -> channel 3
##.#### -> channel 4,5
##.#### -> channel 0,1
```

Warning!

Only even channels can be set as differential. An odd channel will become unavailable if its preceding channel is set as differential. Only for PCL-1710/1710L/1710H/1710HG/1710HGL/1716/1716L

C.7 Control Register — BASE+6

The write-only register BASE+6 and BASE+7 allows users to set an A/D trigger source and an interrupt source.

Table C-9 Control Register

Write	A/D Status Register							
Bit #	7	6	5	4	3	2	1	0
BASE + 7	* CAL							
BASE + 6	*AD16/12	CNT0	ONE/FH	IRQEN	GATE	EXT	PACER	SW

*: AD16/12 and CAL are only supported for PCI-1716/1716L

SW Software trigger enable bit

1 enable

0 disable.

PACER Pacer trigger enable bit

1 enable

0 disable.

EXT External trigger enable bit

1 enable;

0 disable.

Note:

Users cannot enable SW, PACER and EXT concurrently.

GATE External trigger gate function enable bit.

0 Disable

1 Enable

IRQEN	Interrupt enable bit.
	0 Disable
	1 Enable
ONE/FH	Interrupt source bit
	0 Interrupt when an A/D conversion occurs
	1 Interrupt when the FIFO is half full.
CNT0	Counter 0 clock source select bit
	0 The clock source of Counter 0 comes from the internal clock 1 MHz for PCI-1711/1711L/1716/1716L 100 KHz for PCI-1710/1710L/1710HG/ 1710HGL
	1 The clock source of Counter 0 comes from the external clock maximum up to 10 MHz for PCI-1711/1711L/ 1716/1716L maximum up to 1 MHz for PCI-1710/1710L/ 1710HG/1710HGL
AD16/12	Analog Input resolution.
	0 16 bit
	1 12 bit. And those two registers BASE+0 & BASE+1 will the same as PCI-1710/1710L/1710HG/1710HGL/1711/1711L (<i>Table C-2</i>)
CAL	Analog I/O calibration bit
	0 Normal mode All analog input and outputs channels are

connected to 68 pin SCSI-II connector respectively.

1 A/D and D/A calibration mode

The wiring becomes that AI0 is connected to 0 V (AGND), AI2 is connected to +5 V, AI4 is connected to AO0, and AI6 is connected to AO1 automatically.

C.8 Status Register — BASE+6 and BASE+7

The registers of BASE+6 and BASE+7 provide information for A/D configuration and operation.

Table C-10 Status Register

Write	A/D Control Register							
Bit #	7	6	5	4	3	2	1	0
BASE + 7	*CAL				IRQ	F/F	F/H	F/E
BASE + 6	*AD16/12	CNT0	ONE/FH	IROEN	GATE	EXT	PACER	SW

*: CAL is only supported for PCI-1716/1716L

The content of the status register of BASE+6 is the same as that of the control register.

F/E FIFO Empty flag

This bit indicates whether the FIFO is empty.

1 means that the FIFO is empty.

F/H FIFO Half-full flag

This bit indicates whether the FIFO is half-full.

1 means that the FIFO is half-full.

F/F FIFO Full flag

This bit indicates whether the FIFO is full.

1 means that the FIFO is full.

IRQ Interrupt flag

This bit indicates the interrupt status.

1 means that an interrupt has occurred.

C.9 Clear Interrupt and FIFO — BASE+8 and BASE+9

Writing data to either of these two bytes clears the interrupt or the FIFO.

Table C-11 Register to clear interrupt and FIFO

Write	Clear Interrupt and FIFO							
Bit #	7	6	5	4	3	2	1	0
BASE + 9	Clear FIFO							
BASE + 8	Clear Interrupt							

C.10 D/A Output Channel 0 — BASE+10 and BASE+11

The PCI-1716 provides the innovative design as *gate control* for Analog Output function. It works as general Analog Output function when you disable the flag (bit 3 (DA0_LDEN) of BASE+14). That means the data will be output immediately. However, when you enable the flag, you need to read these two registers BASE+10 and BASE+11 to output the data to the Analog Output channel.

Table C-12 Register for load D/A channel 0 data

Read	Load D/A Channel 0 data							
Bit #	7	6	5	4	3	2	1	0
BASE + 11								
BASE + 10								

C.11 D/A Output Channel 0 — BASE+10 and BASE+11

The write-only registers of BASE+10 and BASE+11 accept data for D/A Channel 0 output.

PCI-1710L/1710HGL/1711L/1716L

The PCI-1710L/1710HGL/1711L/1716L is not equipped with the D/A functions.

PCI-1711/1710HG/1711/1716

Table C-13 Register for D/A channel 0 data

Write	D/A Output Channel 0							
Bit #	7	6	5	4	3	2	1	0
BASE + 11	*DA15	*DA14	*DA13	*DA12	DA11	DA10	DA9	DA8
BASE + 10	DA7	DA6	DA5	DA4	DA3	DA2	DA1	DA0

*: DA15, DA14, DA13, DA12 are only supported for PCI-1716/1716L

- DA11 ~ DA0** Digital to analog data
- DA0 LSB of the D/A data
 - DA11 MSB of the D/A data (for PCI-1710/1710L/
1710HG/1710HGL/1711/1711L)
 - DA15 MSB of the D/A data (for PCI-1716/1716L)

C.12 D/A Output Channel 1 — BASE+12 and BASE+13

The PCI-1716 provides the innovative design as *gate control* for Analog Output function. It works as general Analog Output function when you disable the flag (bit 11 (DA1_LDEN) of BASE+14). That means the data will be output immediately. However, when you enable the flag, you need to read these two registers BASE+12 and BASE+13 to output the data to the Analog Output channel.

Table C-14 Register for load D/A channel 1 data

Read	Load D/A Channel 1 data							
Bit #	7	6	5	4	3	2	1	0
BASE + 13								
BASE + 12								

C.13 D/A Output Channel 1 — BASE+12 and BASE+13

The write-only registers of BASE+12 and BASE+13 accept data for D/A channel 1 output.

PCI-1710L/1710HGL/1711L/1716L

The PCI-1710L/1710HGL/1711L/1716L is not equipped with the D/A functions.

PCI-1711/1710HG/1711/1716

Table C-15 Register for D/A channel 1 data

Write	D/A Output Channel 1							
Bit #	7	6	5	4	3	2	1	0
BASE + 13	*DA15	*DA14	*DA13	*DA12	DA11	DA10	DA9	DA8
BASE + 12	DA7	DA6	DA5	DA4	DA3	DA2	DA1	DA0

*: DA15, DA14, DA13, DA12 are only supported for PCI-1716/1716L

DA11 ~ DA0 Digital to analog data

DA0 LSB of the D/A data

DA11 MSB of the D/A data (for
PCI-1710/1710L/1710HG/1710HGL/1711/
1711L)

DA15 MSB of the D/A data (for
PCI-1716/1716L)

C.14 D/A Reference Control —BASE+14

The write-only register of BASE+14 allows users to set the D/A reference source.

PCI-1710L/1710HGL/1711L/1716L

The PCI-1710L/1710HGL/1711L/1716L is not equipped with the D/A functions.

PCI-1710/1710HG/1711/1716

Table C-16 PCI-1710/1710HG/1711 Register for D/A reference control

Write	D/A Output Channel 1							
Bit #	7	6	5	4	3	2	1	0
BASE + 14					DA1_I/E	DA1_5/10	DA0/I/E	DA0_5/10

Table C-17 PCI-1716 Register for D/A reference control

Write	D/A Output Channel 1							
Bit #	7	6	5	4	3	2	1	0
BASE + 15					DA1_LDEN	DA1_I/E	DA0_B/U	DA1_5/10
BASE + 14					DA0_LDEN	DA0/I/E	DA0_B/U	DA0_5/10

DA_n_5/10 The internal reference voltage for the D/A output channel *n*

0 - 5 V

1 - 10 V

- DA_n_B/U** for D/A output channel *n*
- 0 Bipolar
 - 1 Unipolar
- DA_n_I/E** Internal or external reference voltage for D/A output channel *n*
- 0 Internal source
 - 1 External source
- DA_n_LDEN** for Gate Control of D/A output channel *n* (Please refer to C.10 and C.12)
- 0 Disable
 - 1 Enable

C.15 Digital I/O Registers — BASE+16 and BASE+17

The PCI-1710/1710L/1710HG/1710HG/1711/1711L/1716/1716L offers 16 digital input channels and 16 digital output channels. These I/O channels use the input and output ports at addresses BASE+16 and BASE+17.

Table C-18 Register for digital input

Read	Digital Input							
Bit #	7	6	5	4	3	2	1	0
BASE + 17	DI15	DI14	DI13	DI12	DI11	DI10	DI9	DI8
BASE + 16	DI7	DI6	DI5	DI4	DI3	DI2	DI1	DI0

Table C-19 Register for digital output

Write	Digital Output							
Bit #	7	6	5	4	3	2	1	0
BASE + 17	DO15	DO14	DO13	DO12	DO11	DO10	DO9	DO8
BASE + 16	DO7	DO6	DO5	DO4	DO3	DO2	DO1	DO0

Note!



The default configuration of the digital output channels is a logic 0.

This avoids damaging external devices during system start-up or reset since the power on status is set to the default value.

C.16 Calibration Registers — BASE+18 and BASE+19

The PCI-1716/1716L offers Calibration registers BASE+16 and BASE+17 for user to calibrate the A/D and D/A.

Table C-20 Calibration Command and Data Register

Write	Calibration Command and Data							
Bit #	7	6	5	4	3	2	1	0
BASE + 19					CM3	CM2	CM1	CM0
BASE + 18	D7	D6	D5	D4	D3	D2	D1	D0

D7 to D0 Calibration data

D0 LSB of the calibration data

D7 MSB of the calibration data

CM3 to CM0 Calibration Command and table C-18 lists the command code for PCI-1716/1716L.

Table C-21 Calibration Command and Data Register

PCI-1716/1716L				
Meaning	Command Code			
	CM3	CM2	CM1	CM0
A/D bipolar offset adjust	0	0	0	0
A/D unipolar offset adjust	0	0	0	1
PGA offset adjust	0	0	1	0
A/D gain adjust	0	0	1	1
D/A 0 gain 1 adjust (10 V)	0	1	0	0
D/A 0 gain 2 adjust (5 V)	0	1	0	1
D/A 0 bipolar offset adjust	0	1	1	0
D/A 0 unipolar offset adjust	0	1	1	1
D/A 1 gain 1 adjust (10 V)	1	0	0	0
D/A 1 gain 2 adjust (5 V)	1	0	0	1
D/A 1 bipolar offset adjust	1	0	1	0
D/A 1 unipolar offset adjust	1	0	1	1

C.17 Board ID Registers — BASE+20

The PCI-1710/1710L/1710HG/1710HGL/1716/1716L offers Board ID register BASE+20. With correct Board ID settings, user can easily identify and access each card during hardware configuration and software programming.

Table C-22 Register for Board ID

Read	Board ID							
Bit #	7	6	5	4	3	2	1	0
BASE + 20					BD3	BD2	BD1	BD0

C.18 Programmable Timer/Counter Registers

BASE+24, BASE+26, BASE+28 and BASE+30

The four registers of BASE+24, BASE+26, BASE+28 and BASE+30 are used for the 82C54 programmable timer/counter. Please refer to *Appendix D 82C54 Counter Chip Functions* for detailed application information.

Note:

Users have to use a 16-bit (word) command to read/write each register.

(This page is left blank for hard printing.)

Appendix D. 82C54 Counter Chip Function

D.1 The Intel 82C54

The PCI-1710/1710L/1710HG/1710HGL/1711/1711L/1716/1716L uses one Intel 82C54 compatible programmable interval timer/counter chip. The popular 82C54 offers three independent 16-bit counters, counter 0, counter 1 and counter 2. Each counter has a clock input, control gate and an output. You can program each counter for maximum count values from 2 to 65535.

The 82C54 has a maximum input clock frequency of 10 MHz. The PCI-1710/1710L/1710HG/1710HGL/1711/1711L/1716/1716L provides 10 MHz input frequencies to the counter chip from an on-board crystal oscillator.

Counter 0

On the PCI-1710/1710L/1710HG/1710HGL/1711/1711L/1716/1716L, counter 0 can be a 16-bit timer or an event counter, selectable by users. When the clock source is set as an internal source, counter 0 is a 16-bit timer; when set as an external source, then counter 0 is an event counter and the clock source comes from CNT0_CLK. The counter is controlled by CNT0_GATE. When CNT0_GATE input is high, counter 0 will begin to count.

Counter 1 & 2

Counter 1 and counter 2 of the counter chip are cascaded to create a 32-bit timer for the pacer trigger. A low-to-high edge of counter 2 output (PACER_OUT) will trigger an A/D conversion. At the same time, you can use this signal as a synchronous signal for other applications.

D.2 Counter Read/Write and Control Registers

The 82C54 programmable interval timer uses four registers at addresses $\text{BASE} + 24(\text{Dec})$, $\text{BASE} + 26(\text{Dec})$, $\text{BASE} + 28(\text{Dec})$ and $\text{BASE} + 30(\text{Dec})$ for read, write and control of counter functions.

Register functions appear below:

Register	Function
$\text{BASE} + 24(\text{Dec})$	Counter 0 read/write
$\text{BASE} + 26(\text{Dec})$	Counter 1 read/write
$\text{BASE} + 28(\text{Dec})$	Counter 2 read/write
$\text{BASE} + 30(\text{Dec})$	Counter control word

Since the 82C54 counter uses a 16-bit structure, each section of read/write data is split into a least significant byte (LSB) and most significant byte (MSB). To avoid errors, it is important that you make read/write operations in pairs and keep track of the byte order.

The data format for the control register is as below:

BASE+30(Dec) 82C54 control, standard mode								
Bit	D7	D6	D5	D4	D3	D2	D1	D0
Value	SC1	SC0	RW1	RW0	M2	M1	M0	BCD

Description:

SC1 & SC0 Select counter

Counter	SC1	SC0
0	0	0
1	0	1
2	1	0
Read-back command	1	1

RW1 & RW0 Select read / write operation

Operation	RW1	RW0
Counter latch	0	0
Read/write LSB	0	1
Read/write MSB	1	0
Read/write LSB first, then MSB	1	1

M2, M1 & M0 Select operating mode

M2	M1	M0	Mode	Description
0	0	0	0	Stop on terminal count
0	0	1	1	Programmable one shot
X	1	0	2	Rate generator
X	1	1	3	Square wave rate generator
1	0	0	4	Software triggered strobe
1	0	1	5	Hardware triggered strobe

BCD Select binary or BCD counting

BCD	Type
-----	------

0	Binary counting 16-bits
---	-------------------------

1	Binary coded decimal (BCD) counting
---	-------------------------------------

If you set the module for binary counting, the count can be any number from 0 up to 65535. If you set it for BCD (Binary Coded Decimal) counting, the count can be any number from 0 to 9999.

If you set both SC1 and SC0 bits to 1, the counter control register is in read-back command mode. The control register data format then becomes:

BASE + 30(Dec) 82C54 control, read-back mode

Bit	D7	D6	D5	D4	D3	D2	D1	D0
-----	----	----	----	----	----	----	----	----

Value	1	1	CNT	STA	C2	C1	C0	X
-------	---	---	-----	-----	----	----	----	---

CNT = 0 Latch count of selected counter(s)

STA = 0 Latch status of selected counter(s)

C2, C1 & C0 Select counter for a read-back operation

C2 = 1 select Counter 2

C1 = 1 select Counter 1

C0 = 1 select Counter 0

If you set both SC1 and SC0 to 1 and STA to 0, the register selected

by C2 to C0 contains a byte which shows the status of the counter.

The data format of the counter read/write register then becomes:

BASE+24/26/28(Dec) Status read-back mode

Bit	D7	D6	D5	D4	D3	D2	D1	D0
Value	OUT	NC	RW1	RW0	M2	M1	M0	BCD

OUT Current state of counter output

NC Null count is 1 when the last count written to the counter register has been loaded into the counting element

D.3 Counter Operating Modes

MODE 0 – Stop on Terminal Count

The output will initially be low after you set this mode of operation. After you load the count into the selected count register, the output will remain low and the counter will count. When the counter reaches the terminal count, its output will go high and remain high until you reload it with the mode or a new count value. The counter continues to decrement after it reaches the terminal count. Rewriting a counter register during counting has the following results:

1. Writing to the first byte stops the current counting.
2. Writing to the second byte starts the new count.

MODE 1 – Programmable One-shot Pulse

The output is initially high. The output will go low on the count following the rising edge of the gate input. It will then go high on the terminal count. If you load a new count value while the output is low, the new value will not affect the duration of the one-shot pulse until the succeeding trigger. You can read the current count at any time without affecting the one-shot pulse. The one-shot is re-triggerable, thus the output will remain low for the full count after any rising edge at the gate input.

MODE 2 – Rate Generator

The output will be low for one period of the input clock. The period from one output pulse to the next equals the number of input counts in the counter register. If you reload the counter register between output

pulses, the present period will not be affected, but the subsequent period will reflect the value.

The gate input, when low, will force the output high. When the gate input goes high, the counter will start from the initial count. You can thus use the gate input to synchronize the counter.

With this mode the output will remain high until you load the count register. You can also synchronize the output by software.

MODE 3 – Square Wave Generator

This mode is similar to Mode 2, except that the output will remain high until one half of the count has been completed (for even numbers), and will go low for the other half of the count. This is accomplished by decreasing the counter by two on the falling edge of each clock pulse. When the counter reaches the terminal count, the state of the output is changed, the counter is reloaded with the full count and the whole process is repeated.

If the count is odd and the output is high, the first clock pulse (after the count is loaded) decrements the count by 1. Subsequent clock pulses decrement the count by 2. After time-out, the output goes low and the full count is reloaded. The first clock pulse (following the reload) decrements the counter by 3. Subsequent clock pulses decrement the count by two until time-out, then the whole process is repeated. In this way, if the count is odd, the output will be high for

$(N+1)/2$ counts and low for $(N-1)/2$ counts.

MODE 4 –Software-Triggered Strobe

After the mode is set, the output will be high. When the count is loaded, the counter will begin counting. On terminal count, the output will go low for one input clock period then go high again. If you reload the count register during counting, the new count will be loaded on the next CLK pulse. The count will be inhibited while the GATE input is low.

MODE 5 – Hardware-Triggered Strobe

The counter will start counting after the rising edge of the trigger input and will go low for one clock period when the terminal count is reached. The counter is re-triggerable.

D.4 Counter Operations

Read/Write Operation

Before you write the initial count to each counter, you must first specify the read/write operation type, operating mode and counter type in the control byte and write the control byte to the control register [BASE + 30(Dec)].

Since the control byte register and all three counter read/write registers have separate addresses and each control byte specifies the counter it applies to (by SC1 and SC0), no instructions on the operating sequence are required. Any programming sequence following the 82C54 convention is acceptable.

There are three types of counter operation: Read/load LSB, read /load MSB and read /load LSB followed by MSB. It is important that you make your read/write operations in pairs and keep track of the byte order.

Counter Read-back Command

The 82C54 counter read-back command lets you check the count value, programmed mode and current states of the OUT pin and Null Count flag of the selected counter(s). You write this command to the control word register. Format is as shown at the beginning of this section. The read-back command can latch multiple counter output latches. Simply set the CNT bit to 0 and select the desired counter(s). This single command is functionally equivalent to multiple counter

latch commands, one for each counter latched.

The read-back command can also latch status information for selected counter(s) by setting STA bit = 0. The status must be latched to be read; the status of a counter is accessed by a read from that counter. The counter status format appears at the beginning of the chapter.

Counter Latch Operation

Users often want to read the value of a counter without disturbing the count in progress. You do this by latching the count value for the specific counter then reading the value.

The 82C54 supports the counter latch operation in two ways. The first way is to set bits RW1 and RW0 to 0. This latches the count of the selected counter in a 16-bit hold register. The second way is to perform a latch operation under the read-back command. Set bits SC1 and SC0 to 1 and CNT = 0. The second method has the advantage of operating several counters at the same time. A subsequent read operation on the selected counter will retrieve the latched value.

(This page is left blank for hard printing.)

Appendix E. PCI-1716/1716L Calibration (Manually)

E.1 A/D Calibration

Regular and proper calibration procedures ensure the maximum possible accuracy. It is easy to complete the A/D calibration procedure automatically (i.e. through software calibration) by executing the A/D calibration program *AutoCali.EXE*. Therefore, it is not necessary to adjust the hardware settings of the PCI-1716/1716L. However, the following calibration steps are also provided for your reference in case manual calibration is needed:

1. Adjust the on board reference voltage. First, adjust VR1 until the reference voltage on TP4 has reached +5.0000 V. Next, to write 0x0080, 0x0180, 0x0280 and 0x0380 sequentially to *Calibration Command and Data register* (BASE+18). After that, to set PCI-1716/1716L to AI software trigger and calibration mode.
2. Adjust the **PGA** offset voltage. First, writing any value to BASE+9 to clear FIFO. Then to set A/D channel to channel 0.
3. Writing the *value* from 0x0200 to 0x02FF sequentially to *Calibration Command and Data register* (BASE+18), and get each bipolar range' s data by software trigger A/D method. Be noted that to repeat this procedure 1000 times then to average those data for each *value*. After that, to compare the average data of the range between ± 5 V and ± 0.625 V and to see whether the

discrepancy is less than 2 LSB. If so, to go to next step. Otherwise, you must change the **value** and repeat all the procedure in this step again until the discrepancy is less than 2 LSB.

4. Adjust the **BIPOLAR** offset voltage. First, writing any value to BASE+9 to clear FIFO. Then to set A/D channel to channel 0, and to set the range as -5 V to +5 V.
5. Writing the **value** from 0x0000 to 0x00FF sequentially to *Calibration Command and Data register* (BASE+18), and get each bipolar range's data by software trigger A/D method. Be noted that to repeat this procedure 1000 times then to average those data for each **value**. After that, to see whether the average data is close to 32767.5. If so, to go to next step. Otherwise, you must change the **value** and repeat all the procedure in this step again until the average data close to 32767.5.
6. Adjust **UNIPOLAR** offset voltage. First, writing any value to BASE+9 to clear FIFO. Then to set A/D channel to channel 0, and to set the range as 0 V to 10 V.
7. Writing the **value** from 0x0100 to 0x01FF sequentially to *Calibration Command and Data register* (BASE+18), and get each bipolar range's data by software trigger A/D method. Be noted that to repeat this procedure 1000 times then to average those data for each **value**. After that, to see whether the average data is close to 32767.5. If so, to go to next step. Otherwise, you must change the **value** and repeat all the procedure in this step again until the average data close to 32767.5.
8. Adjust **GAIN** offset voltage. First, writing any value to BASE+9

to clear FIFO. Then to set A/D channel to channel 2, and to set the range as -5 V to +5 V.

9. Writing the **value** from 0x0300 to 0x03FF sequentially to *Calibration Command and Data register* (BASE+18), and get each bipolar range' s data by software trigger A/D method. Be noted that to repeat this procedure 1000 times then to average those data for each **value**. After that, to see whether the average data is close to 65534.6. If so, to go to next step. Otherwise, you must change the **value** and repeat all the procedure in this step again until the average data close to 65534.6.
10. Repeat steps 2 to 9 several times.

Table E-1 A/D binary code table

A/D code		Mapping Voltage	
Hex.	Dec.	Bipolar	Unipolar
0000h	0	-FS	0
7FFFh	32767	-1 LSB	0.5 FS - 1 LSB
8000h	32768	0	0.5 FS
FFFFh	65535	+FS - 1 LSB	FS - 1 LSB

Note

- $1 \text{ LSB} = \text{FS} / 65535$ for Unipolar
(For example: $1\text{LSB} = 10 / 65535$, while the range is 0 V to 10 V)
 - $1 \text{ LSB} = +\text{FS} / 32768$ for Bipolar
(For example: $1\text{LSB} = 5 / 32768$, while the range is -5 V to +5 V)
-

E.2 D/A Calibration (for PCI-1716 only)

You can select an on-board +5V or +10V *internal reference voltage* or an *external voltage* as your analog output reference voltage. If you use an external reference, connect the reference voltage within the $\pm 10V$ range to the reference input of the D/A output channel you want to calibrate. Then adjust the gain value, unipolar offset voltage, bipolar offset voltage, respectively, of D/A channels 0 and 1 with the *Calibration Command and Data register* (BASE+18).

Note:

Using a precision voltmeter to calibrate the D/A outputs is recommended.

The auto-calibration program *AutoCali.EXE* helps you finish the D/A calibration procedure automatically. In order to get the maximum possible accuracy of the D/A channels, you need to calibrate the A/D channels first. Although the procedure is not necessary, the following calibration steps are provided below for your reference in case you want to implement the calibration yourself:

1. Writing 0x0400, 0x0500, 0x0600, 0x0700, 0x0800, 0x0900, 0x0A00 and 0x0B00 sequentially to *Calibration Command and Data register* (BASE+18). Next, to set PCI-1716/1716L to AI software trigger and calibration mode. After that, to set the A/D channel to corresponding D/A channel. That means connected A/D channel 4 to D/A channel 0, connected A/D channel 6 to D/A channel 1.
2. Adjust **GAIN 10V** calibration. First, writing any value to

BASE+9 to clear FIFO. Then to set the A/D range as 0 V to 10 V, and to set the D/A range as 0 V to 10 V. Next, writing 0xFFFF to corresponding *D/A registers* (BASE+10 and BASE+12).

3. Writing the **value** from 0x0400 to 0x04FF sequentially to *Calibration Command and Data register* (BASE+18), and get each bipolar range's data by software trigger A/D method. Be noted that to repeat this procedure 1000 times then to average those data for each **value**. After that, to see whether the average data is close to 65534.6. If so, to go to next step. Otherwise, you must change the **value** and repeat all the procedure in this step again until the average data close to 65534.6.
4. Adjust **GAIN 5V** calibration. First, writing any value to BASE+9 to clear FIFO. Then to set the A/D range as -5 V to +5 V, and to set the D/A range as 0 V to 5 V. Next, writing 0xFFFF to corresponding *D/A registers* (BASE+10 and BASE+12).
5. Writing the **value** from 0x0500 to 0x05FF sequentially to *Calibration Command and Data register* (BASE+18), and get each bipolar range's data by software trigger A/D method. Be noted that to repeat this procedure 1000 times then to average those data for each **value**. After that, to see whether the average data is close to 65534.6. If so, to go to next step. Otherwise, you must change the **value** and repeat all the procedure in this step again until the average data close to 65534.6.
6. Adjust **BIPOLAR** offset calibration. First, writing any value to BASE+9 to clear FIFO. Then to set the A/D range as -5 V to +5 V, and to set the D/A range as -5 V to +5 V. Next, writing 0x0000 to

corresponding *D/A registers* (BASE+10 and BASE+12).

7. Writing the *value* from 0x0600 to 0x06FF sequentially to *Calibration Command and Data register* (BASE+18), and get each bipolar range's data by software trigger A/D method. Be noted that to repeat this procedure 1000 times then to average those data for each *value*. After that, to see whether the discrepancy is less than 0.4 LSB. If so, to go to next step. Otherwise, you must change the *value* and repeat all the procedure in this step again until the discrepancy is less than 0.4 LSB.
8. Adjust **UNIPOLAR** offset calibration. First, writing any value to BASE+9 to clear FIFO. Then to set the A/D range as -5 V to +5 V, and to set the D/A range as 0 V to 5 V. Next, writing 0x8000 to corresponding *D/A registers* (BASE+10 and BASE+12).
9. Writing the *value* from 0x0600 to 0x06FF sequentially to *Calibration Command and Data register* (BASE+18), and get each bipolar range's data by software trigger A/D method. Be noted that to repeat this procedure 1000 times then to average those data for each *value*. After that, to see whether the average data is close to 32767.5. If so, to go to next step. Otherwise, you must change the *value* and repeat all the procedure in this step again until the average data close to 32767.5.
10. Repeat steps 2 to 9 several times.

Table E-2 D/A binary code table

A/D code		Mapping Voltage	
Hex.	Dec.	Bipolar	Unipolar
0000h	0	-FS	0
7FFFh	32767	-1 LSB	0.5 FS - 1 LSB
8000h	32768	0	0.5 FS
FFFFh	65535	+FS - 1 LSB	FS - 1 LSB

Note

- $1 \text{ LSB} = \text{FS} / 65535$ for Unipolar
(For example: $1 \text{ LSB} = 10 / 65535$, while the range is 0 V to 10 V)
 - $1 \text{ LSB} = +\text{FS} / 32768$ for Bipolar
(For example: $1 \text{ LSB} = 5 / 32768$, while the range is -5 V to +5 V)
-

(This page is left blank for hard printing.)

Appendix F. Screw-terminal Board

F.1 Introduction

The PCLD-8710 Screw-terminal Board provides convenient and reliable signal wiring for the PCI-1710/1710L/1710HG/1710HGL/1711/1711L/1716/1716L, both of which have a 68-pin SCSI-II connector.

This screw terminal board also includes cold junction sensing circuitry that allows direct measurement of thermocouples transducers. Together with software compensation and linearization, every thermocouple type can be accommodated.

Due to its special PCB layout you can install passive components to construct your own signal-conditioning circuits. The user can easily construct a low-pass filter, attenuator or current shunt converter by adding resistors and capacitors on to the board's circuit pads.

This appendix is a brief introduction for the PCLD-8710 Screw-terminal Board. Please refer to the *User's Manual of PCLD-8710* for detailed information.

F.2 Features

- ◆ Low-cost screw-terminal board for the PCI-1710/1710L/1710HG/1710HGL/1711/1711L/1716/1716L with 68-pin SCSI-II connector.
- ◆ On-board CJC (Cold Junction Compensation) circuits for direct thermocouple measurement.
- ◆ Reserved space for signal-conditioning circuits such as low-pass filter, voltage attenuator and current shunt.
- ◆ Industrial-grade screw-clamp terminal blocks for heavy-duty and reliable connections.
- ◆ DIN-rail mounting case for easy mounting.
- ◆ Dimensions: 169 mm (W) x 112mm (L) x 51mm (H) (6.7" x 4.4" x 2.0"")

F.3 Applications

Field wiring for the PCI-1710/1710L/1710HG/1710HGL/1711/1711L/1716/1716L equipped with 68-pin SCSI-II connector.