

User Manual

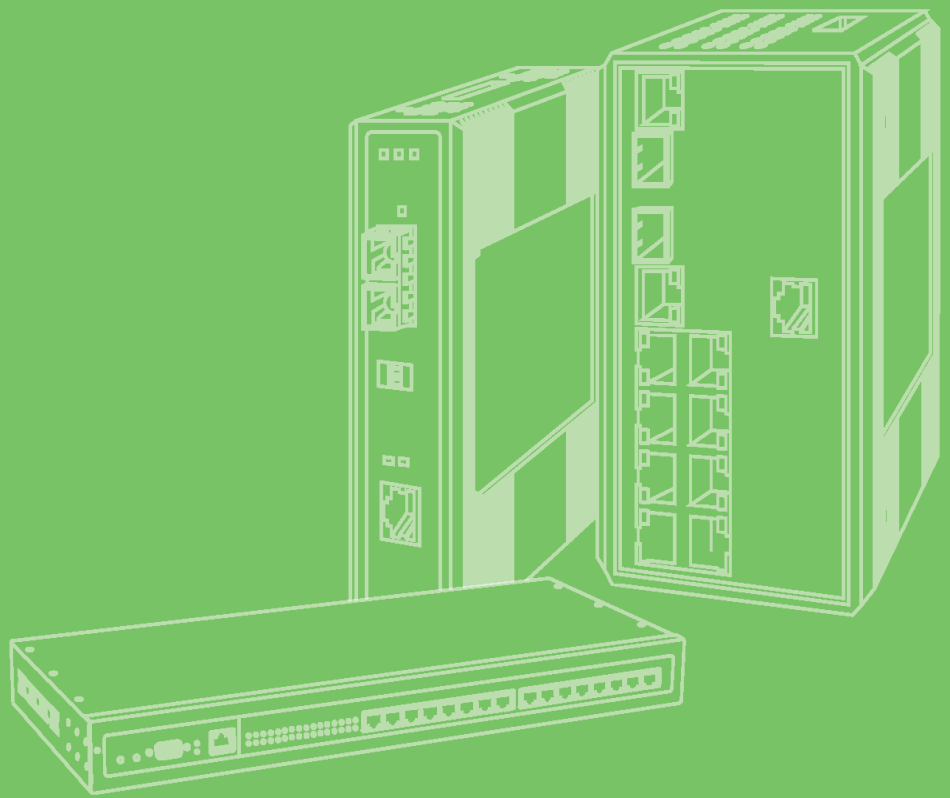

EKI-1351/1352

**1/2-port RS-232/422/485 to
802.11b/g WLAN Serial Device
Servers**

ADVANTECH

eAutomation

Copyright

The documentation and the software included with this product are copyrighted 2008 by Advantech Co., Ltd. All rights are reserved. Advantech Co., Ltd. reserves the right to make improvements in the products described in this manual at any time without notice. No part of this manual may be reproduced, copied, translated or transmitted in any form or by any means without the prior written permission of Advantech Co., Ltd. Information provided in this manual is intended to be accurate and reliable. However, Advantech Co., Ltd. assumes no responsibility for its use, nor for any infringements of the rights of third parties, which may result from its use.

Acknowledgements

Intel and Pentium are trademarks of Intel Corporation.

Microsoft Windows and MS-DOS are registered trademarks of Microsoft Corp.

All other product names or trademarks are properties of their respective owners.

Product Warranty (2 years)

Advantech warrants to you, the original purchaser, that each of its products will be free from defects in materials and workmanship for two years from the date of purchase.

This warranty does not apply to any products which have been repaired or altered by persons other than repair personnel authorized by Advantech, or which have been subject to misuse, abuse, accident or improper installation. Advantech assumes no liability under the terms of this warranty as a consequence of such events.

Because of Advantech's high quality-control standards and rigorous testing, most of our customers never need to use our repair service. If an Advantech product is defective, it will be repaired or replaced at no charge during the warranty period. For out-of-warranty repairs, you will be billed according to the cost of replacement materials, service time and freight. Please consult your dealer for more details.

If you think you have a defective product, follow these steps:

1. Collect all the information about the problem encountered. (For example, CPU speed, Advantech products used, other hardware and software used, etc.) Note anything abnormal and list any onscreen messages you get when the problem occurs.
2. Call your dealer and describe the problem. Please have your manual, product, and any helpful information readily available.
3. If your product is diagnosed as defective, obtain an RMA (return merchandise authorization) number from your dealer. This allows us to process your return more quickly.
4. Carefully pack the defective product, a fully-completed Repair and Replacement Order Card and a photocopy proof of purchase date (such as your sales receipt) in a shippable container. A product returned without proof of the purchase date is not eligible for warranty service.
5. Write the RMA number visibly on the outside of the package and ship it prepaid to your dealer.

Part No. 2003135101

Printed in Taiwan

Edition 2

January 2009

Declaration of Conformity

CE

This product has passed the CE test for environmental specifications. Test conditions for passing included the equipment being operated within an industrial enclosure. In order to protect the product from being damaged by ESD (Electrostatic Discharge) and EMI leakage, we strongly recommend the use of CE-compliant industrial enclosure products.

FCC Class B

Note: This equipment has been tested and found to comply with the limits for a Class B digital device, pursuant to part 15 of the FCC Rules. These limits are designed to provide reasonable protection against harmful interference in a residential installation. This equipment generates, uses and can radiate radio frequency energy and, if not installed and used in accordance with the instructions, may cause harmful interference to radio communications. However, there is no guarantee that interference will not occur in a particular installation. If this equipment does cause harmful interference to radio or television reception, which can be determined by turning the equipment off and on, the user is encouraged to try to correct the interference by one or more of the following measures:

- Reorient or relocate the receiving antenna.
- Increase the separation between the equipment and receiver.
- Connect the equipment into an outlet on a circuit different from that to which the receiver is connected.

Consult the dealer or an experienced radio/TV technician for help.

Technical Support and Assistance

1. Visit the Advantech web site at www.advantech.com/support where you can find the latest information about the product.
2. Contact your distributor, sales representative, or Advantech's customer service center for technical support if you need additional assistance. Please have the following information ready before you call:
 - Product name and serial number
 - Description of your peripheral attachments
 - Description of your software (operating system, version, application software, etc.)
 - A complete description of the problem
 - The exact wording of any error messages

Safety Instructions

1. Read these safety instructions carefully.
2. Keep this User Manual for later reference.
3. Disconnect this equipment from any AC outlet before cleaning. Use a damp cloth. Do not use liquid or spray detergents for cleaning.
4. For plug-in equipment, the power outlet socket must be located near the equipment and must be easily accessible.
5. Keep this equipment away from humidity.

6. Put this equipment on a reliable surface during installation. Dropping it or letting it fall may cause damage.
7. The openings on the enclosure are for air convection. Protect the equipment from overheating. **DO NOT COVER THE OPENINGS.**
8. Make sure the voltage of the power source is correct before connecting the equipment to the power outlet.
9. Position the power cord so that people cannot step on it. Do not place anything over the power cord.
10. All cautions and warnings on the equipment should be noted.
11. If the equipment is not used for a long time, disconnect it from the power source to avoid damage by transient overvoltage.
12. Never pour any liquid into an opening. This may cause fire or electrical shock.
13. Never open the equipment. For safety reasons, the equipment should be opened only by qualified service personnel.
14. If one of the following situations arises, get the equipment checked by service personnel:
 - The power cord or plug is damaged.
 - Liquid has penetrated into the equipment.
 - The equipment has been exposed to moisture.
 - The equipment does not work well, or you cannot get it to work according to the user's manual.
 - The equipment has been dropped and damaged.
 - The equipment has obvious signs of breakage.
15. **DO NOT LEAVE THIS EQUIPMENT IN AN ENVIRONMENT WHERE THE STORAGE TEMPERATURE MAY GO BELOW -20° C (-4° F) OR ABOVE 60° C (140° F). THIS COULD DAMAGE THE EQUIPMENT. THE EQUIPMENT SHOULD BE IN A CONTROLLED ENVIRONMENT.**
16. **CAUTION: DANGER OF EXPLOSION IF BATTERY IS INCORRECTLY REPLACED. REPLACE ONLY WITH THE SAME OR EQUIVALENT TYPE RECOMMENDED BY THE MANUFACTURER, DISCARD USED BATTERIES ACCORDING TO THE MANUFACTURER'S INSTRUCTIONS.**
17. The sound pressure level at the operator's position according to IEC 704-1:1982 is no more than 70 dB (A).

DISCLAIMER: This set of instructions is given according to IEC 704-1. Advantech disclaims all responsibility for the accuracy of any statements contained herein.

Safety Precaution - Static Electricity

Follow these simple precautions to protect yourself from harm and the products from damage.

- To avoid electrical shock, always disconnect the power from your PC chassis before you work on it. Don't touch any components on the CPU card or other cards while the PC is on.
- Disconnect power before making any configuration changes. The sudden rush of power as you connect a jumper or install a card may damage sensitive electronic components.

Contents

Chapter 1	Overview.....	1
1.1	Introduction	2
1.2	Features	3
1.3	Specifications	3
1.4	Package Check List	4
Chapter 2	Getting Started.....	5
2.1	Understanding EKI-1351/1352.....	6
2.1.1	Product Description.....	6
	Figure 2.1 Wireless LAN Connections.....	6
2.1.2	COM Port Redirector (Virtual COM Port).....	7
	Figure 2.2 COM Port Redirector	7
	Figure 2.3 Multi-Access Mode	8
2.1.3	TCP Server Mode	9
	Figure 2.4 TCP Server Mode	9
2.1.4	TCP Client Mode.....	9
	Figure 2.5 TCP Client Mode	9
2.1.5	Serial Tunneling Mode	10
	Figure 2.6 Serial Tunneling Mode.....	10
2.1.6	UDP Server/Client Mode.....	10
2.1.7	Control Mode	10
2.2	Hardware.....	11
2.2.1	LED Indicators	11
	Table 2.1: EKI-1351/1352 LED Indicators	11
2.2.2	Dimensions (Units: mm).....	12
	Figure 2.7 Front View of EKI-1351/1352	12
	Figure 2.8 Side View of EKI-1351/1352.....	12
	Figure 2.9 Back View of EKI-1351/1352.....	13
	Figure 2.10 Top View of EKI-1351/1352.....	13
2.3	Connecting Hardware	14
2.3.1	Choosing the Location	14
2.3.2	Panel/Wall Mounting	14
	Figure 2.11 Combine the Metal Mounting Kit	14
2.3.3	DIN-rail Mounting	15
	Figure 2.12 DIN-rail Step 1	15
	Figure 2.13 DIN-rail Step 2	15
2.3.4	Switch Settings	16
	Table 2.2: Default Settings of Diagnostic Mode	16
2.3.5	Wireless Connection	17
2.3.6	Power Connection.....	17
	Figure 2.14 Power Connector.....	17
2.3.7	Serial Connection.....	18
	Table 2.3: EKI-1351/1352 Serial Pin Assignments.....	18
2.4	Serial Device Server Configuration Utility	18
Chapter 3	Configuration	21
3.1	Configuration Utility Overview	22
3.2	Discovering Serial Device Servers	23
3.2.1	Auto Searching	23
3.2.2	Clear Device List and Search Again	26
3.2.3	Manual Appending	26

3.3	Network Settings.....	27
3.3.1	Wireless Basics	29
3.3.2	Wireless Authentication	32
3.3.3	Wireless Advanced	34
3.4	Serial Settings.....	35
3.4.1	Setting Serial Port Parameters	36
3.4.2	Setting Virtual COM Operating Mode Parameters.....	37
3.4.3	Setting TCP/UDP Server/Client Operating Mode Parameters....	39
3.4.4	Setting Control Operating Mode Parameters.....	41
	Table 3.1: AT Commands List.....	42
3.4.5	Advanced Setting.....	43
3.5	Security Configuration.....	44
3.5.1	Accessible Function.....	44
3.5.2	Port Monitor	45
3.6	Fulfilling Administrator Functions	45
3.6.1	Import/Export Serial Port Setting	46
3.6.2	Locate Serial Device.....	46
3.6.3	Lock Device	47
3.6.4	Restore to Factory Default Settings.....	47
3.6.5	Upgrading the Firmware	48
Chapter 4	Setting COM Redirector	51
4.1	Setting COM Redirector(Virtual COM port).....	52
4.1.1	Auto Mapping.....	52
4.1.2	Manual Mapping	54
4.1.3	Manual Direct Mapping Virtual COM Port.....	56
4.1.4	Remove the Virtual COM Port	56
4.2	Running Diagnostic Test.....	57
Chapter 5	Web-Based Configuration.....	59
5.1	Overview	60
5.2	Accessing the Web Page.....	60
5.3	System	62
5.4	Network Configuration	62
5.5	Port Configuration	63
5.6	Change Password.....	64
5.7	Reboot	65
Appendix A	Quick Start.....	67
A.1	Diagnostic Ad hoc Mode	68
A.2	Diagnostic Infrastructure Mode	69

Chapter 1

Overview

1.1 Introduction

Advantech's EKI-1300 series of Industrial Device Servers are a robust, feature-rich, and cost effective way to network-enable equipment in an industrial automation environment. The EKI-1351/1352 provides one or two serial ports, 802.11b/g wireless LAN interface to connect any RS-232/422/485 devices to wireless LAN. These wireless serial device servers provide serial-to-wireless network connectivity as an alternative to wired Ethernet connectivity and enable virtually any serial device or equipment to be remotely accessed, controlled, monitored, or shared on an 802.11b/g wireless network.

By encapsulating serial data and transporting it over Ethernet, the EKI-1351/1352 allows virtual serial links over Ethernet and IP (TCP/IP, UDP/IP networks. After Advantech Serial Device Server Configuration Utility installation, standard serial operation calls are transparently redirected to the serial device servers, guaranteeing compatibility with legacy serial devices and enabling backward compatibility with existing software. EKI-1351/1352 also supports serial tunneling, allowing two native serial devices to communicate over a network without any hosts and programming.

As a result, you can extend limited distance, point-to-point, direct serial connections within the plant, throughout the factory, the facility, the office building, or across the global enterprise.

The EKI-1351/1352 provides an impressive list of features and functions enabling multiple industrial devices to be connected, controlled, configured, managed, and updated over a network. With serial ports and 802.11b/g wireless LAN, the EKI-1351/1352 can easily connects multiple serial devices to a network.

The transmission speed of the EKI-1351/1352 is up to 921.6 Kbps totally outstripping the competition to meet the demand for high-speed exchange. Functionally transparent and efficient, the EKI-1351/1352 is especially designed for remotely controlling and monitoring devices via the Internet.

Type of supported devices:

- Human Machine Interface (HMI)
- Programmable Controller (PLC)
- Flow meters
- Temperature / pressure monitoring equipment
- Gas leak detection device
- Scales
- Power monitoring equipment
- Data Acquisition Modules

EKI-1351/1352 provides various TCP/UDP operations: COM port redirection (Virtual COM port), TCP server/ client and UDP mode. Serial devices can be connected by means of multi-access modes.

1.2 Features

- Expand up 255 serial ports for one Windows 2000/XP/Vista (x86) host
- Link any serial device to an IEEE 802.11 b/g network
- Supports wireless LAN Ad-Hoc and Infrastructure modes
- Supports high transmission speed up to 921.6 kbps
- Supports various operation mode: COM port redirection (Virtual COM), TCP server/client, UDP mode, and Pair Connection
- Supports LED indicators: easy to diagnose
- Supports integrated Configuration Utility and Port-Mapping Utility: easy to configure and manage 255 COM ports and self-diagnosis
- Supports multi-access: allows a max. of 5 hosts to access one serial port
- A max of 4 hosts can be accessed in TCP client and command response mode
- Mounts on DIN-rail, or panel easily
- 15 KV ESD protection for all signals
- Supports DHCP protocol

1.3 Specifications

WLAN Interface

- Standard Compliance: IEEE 802.11 b and IEEE 802.11g
- Network Mode: Infrastructure, Ad-Hoc
- Free Space Range: Outdoor 100m (external antenna with average gain: -2dBi)
- Antenna Connector: Reverse SMA
- Wireless Security: WEP 64-bit/128-bit data encryption

Serial Interface

- Interface: RS-232/422/485, software selectable
- No. of Ports:
 - EKI-1351: 1
 - EKI-1352: 2
- Port Connector: DB9 male
- Baud Rate: 50 bps to 921.6 Kbps
- Parity: None, Even, Odd, Space, Mark
- Data bits: 5, 6, 7, 8
- Stop bits: 1, 1.5, 2
- Flow control: RTS/CTS, XON/XOFF, DTR/DSR
- Signals:
 - RS-232: TxD, RxD, CTS, RTS, DTR, DSR, DCD, RI, GND
 - RS-422: TxD+, TxD-, RxD+, RxD-, GND
 - RS-485: Data+, Data-, GND
- Protection: 15 KV ESD for all signals

Software

- Utility: Advantech Serial Device Server Configuration Utility
- Driver support: Windows 2000/XP/Vista(x86)
- Operation Mode:
 - COM port redirection (Virtual COM)
 - TCP/UDP server (polling) mode
 - TCP/UDP client (event handling) mode
 - Pair connection mode
- Configuration: Web interface, Windows utility
- Protocol: ICMP, IP, TCP, UDP, BOOTP, DHCP, Auto IP, HTTP, ARP

General

- LED indicators:
 - System: Power, System Status
 - WLAN: Signal Strength, Link/Active
 - Serial: Tx, Rx

Power

- Power input: 12 to 48 VDC x 2
- Power connector: Terminal block
- Power Consumption:
 - EKI-1351: 3.5W
 - EKI-1352: 4W

Environmental

- Operation Temperature: 0 to 50°C (32 to 122°F)
- Storage Temperature: -20 to 80°C (-4 to 176°F)
- Operating Humidity: 5 to 95% RH

Regulatory Approvals

- EMC: CE, FCC Part 15 Subpart B (Class A)
- Safety: UL (UL60950-1), Class 1, Div II (pending)

1.4 Package Check List

- 1 x EKI-1351/1352 WLAN serial device server
- 1 x RS-232 loopback DB9 tester
- Panel mounting bracket
- CD-ROM for utility and manual
- EMI Dia. 7.8mm/L82mm Wireless LAN Antenna

Chapter 2

Getting Started

2.1 Understanding EKI-1351/1352

The EKI-1351/1352 is network-based, serial device server for connecting RS-232/422/485 devices, such as CNCs, PLCs, scales, and scanners, directly to a TCP/IP network. Once connected through EKI-1351/1352, serial device will be able to send and receive data on a network like any other network device. It extends traditional COM ports of a PC with access over a TCP/IP network. Through networking, you can control monitor remote serial devices either over a LAN or over the WAN. Since the EKI-1351/1352 is connected through a TCP/IP network, you might need to know some basic facts about networking in order to get the server hooked up correctly.

2.1.1 Product Description

The EKI-1351/1352 is designed to network-enable any RS-232/422/485 serial devices and provides industry-grade hardware and easy-to-use software to make connecting serial devices to an Ethernet network a surprisingly simple process. These units immediately upgrade your existing serial devices for integration into the Internet world. The EKI-1351/1352 features a lot of powerful functions such as: high speed data transfer, access-control, auto-detection of all EKI series products, remote connection from different network domain, remote firmware download, and more.

After the simple installation steps to attach your network and serial device to the appropriate connectors on the serial device servers and driver installation, you will then be able to communicate with the serial devices via its own application software and with the EKI serial device server. COM port redirector, TCP server mode, TCP client mode, UDP server mode, UDP client mode and Control mode are all different schemes to make a serial connection across using one or more Serial device server.

EKI-1351/1352 has 802.11b/g transceiver in addition to its serial and Ethernet ports. Each serial port is connected to the serial communication port of a device. The wireless transceiver connects to another wireless device or to an Access Point (AP).

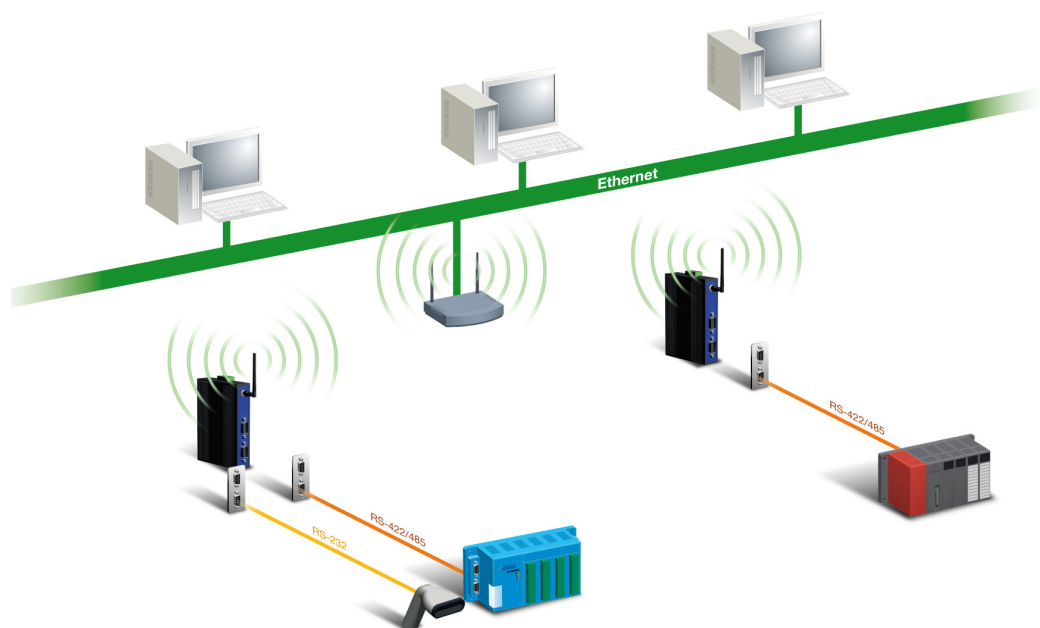

Figure 2.1 Wireless LAN Connections

2.1.2 COM Port Redirector (Virtual COM Port)

Advantech Serial Device Server Configuration Utility is a serial COM port redirector that creates virtual COM ports and provides access to serial device connected to Advantech serial device server. You can configure the serial device server and enable the Virtual COM port using one integrated utility. Advantech Serial Device Server Configuration Utility allows you to configure Microsoft applications to communicate with network enabled serial device servers as easily as if they were physically installed in or directly connected on the PC.

The Advantech redirector can create up to 255 virtual COM ports. Application on the host can open virtual COM port to access the serial device servers at the same time. The redirector will handle each active virtual COM port as a separate TCP connection to Advantech serial device servers.

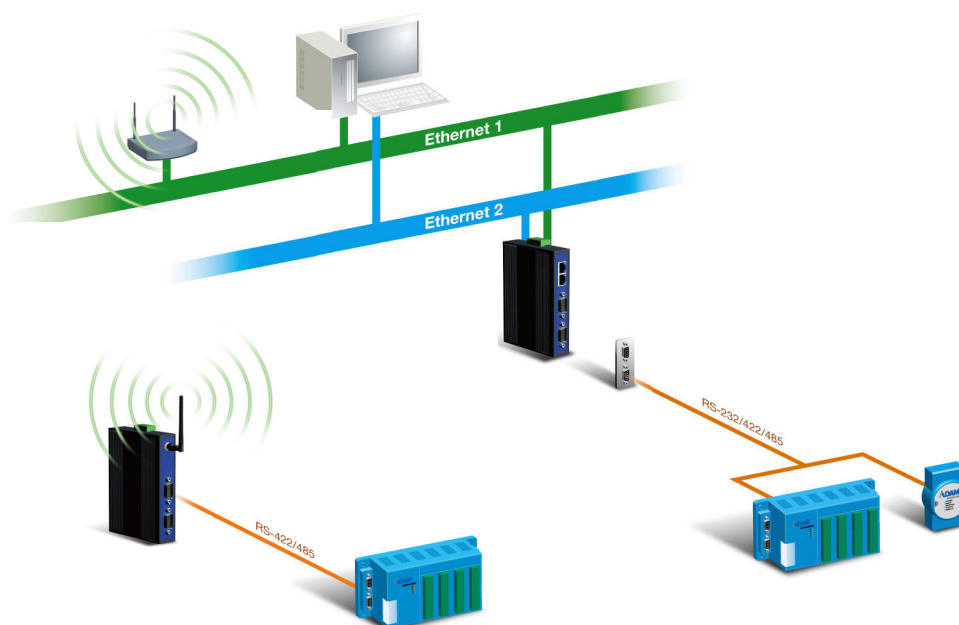

Figure 2.2 COM Port Redirector

2.1.2.1 Normal Mode

The Advantech redirector connects the Advantech serial device servers while an application open the COM port and disconnects from the Advantech serial device servers when the application closes the COM port. The redirector uses TCP network connections to the Advantech serial device server to gain the access to the connected serial devices.

2.1.2.2 Multi-Access Mode (Shared COM port mode)

Most of serial devices are connected directly and physically to the PC serial ports via a cable. The operation system, ex. Windows XP, provides the COM ports that user's application can access, and control the serial device through the serial cable. This means that the serial device can be connected to one host and only one application on this host can handle input, output and control operation on this device.

If you want to run more than one applications to use a serial device, you can employ EKI serial device servers that provide a virtual COM port for a host or multi-hosts on an Ethernet network. EKI serial device server is located between hosts and serial devices. Each serial port on the EKI serial device server can allow max. of five host connections through 802.11b or 802.11g WLAN. There are two major operation modes for Multi-Access Mode. First one is broadcast mode; EKI serial device server handles a command from one application and replies the data from the serial port to all applications that are connecting this serial port. Another one is polling mode; EKI serial device server handles the command from one application and reply to this application only. Query from other applications must be queued and wait for current process completing.

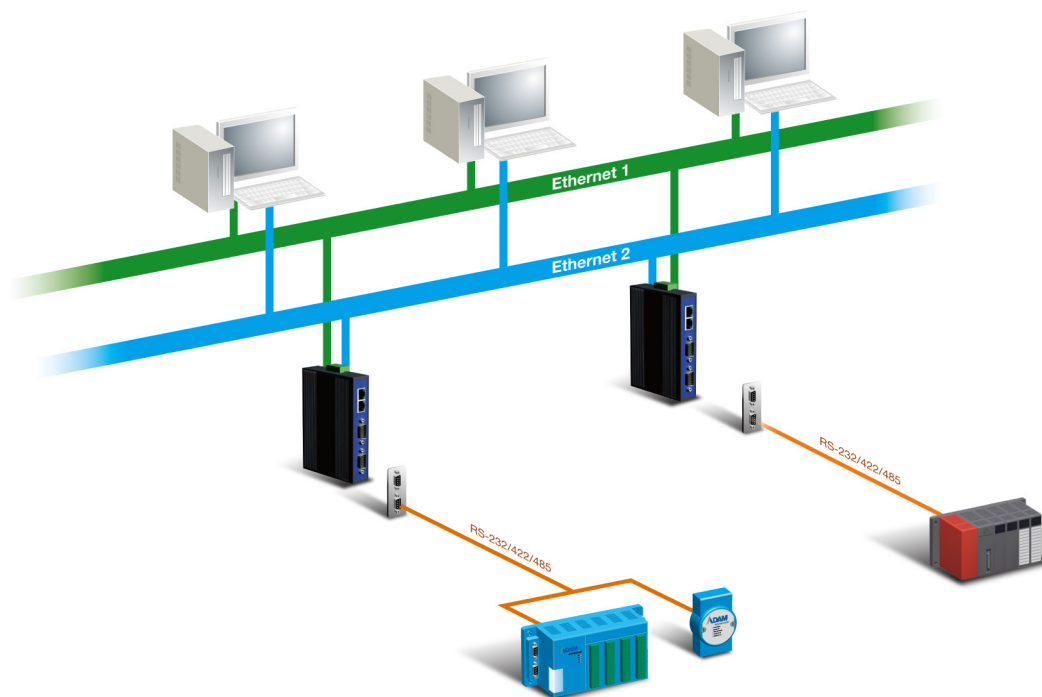

Figure 2.3 Multi-Access Mode

By using a serial device server to share serial device, you eliminate the separate serial lines and serial devices that can be attached to individual hosts. Collecting the data from these serial devices become more easily and more effectively.

2.1.3 TCP Server Mode

In TCP server mode, you might initiate the TCP connection from host to EKI serial device server. This operation mode support max. five simultaneous connections for each serial port on EKI serial device server from one host or several hosts, however multi-hosts collect the data from one serial port at the same time

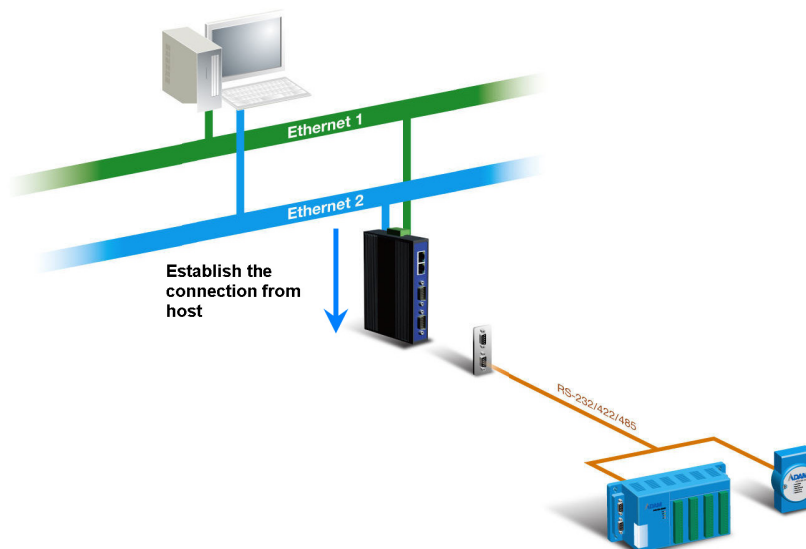

Figure 2.4 TCP Server Mode

2.1.4 TCP Client Mode

In TCP Client mode, the TCP connection will be established from EKI serial device server. This operation mode supports maximum four simultaneous connections for each serial port on EKI-1351/1352 to one host or several hosts. You should configure the IP address and TCP port number of the network hosts which the EKI serial device server connect to using Advantech Serial Device Server Configuration Utility. After configuration, when EKI serial device server receives the data from serial port, the device server will employ the connection to hosts which are configured.

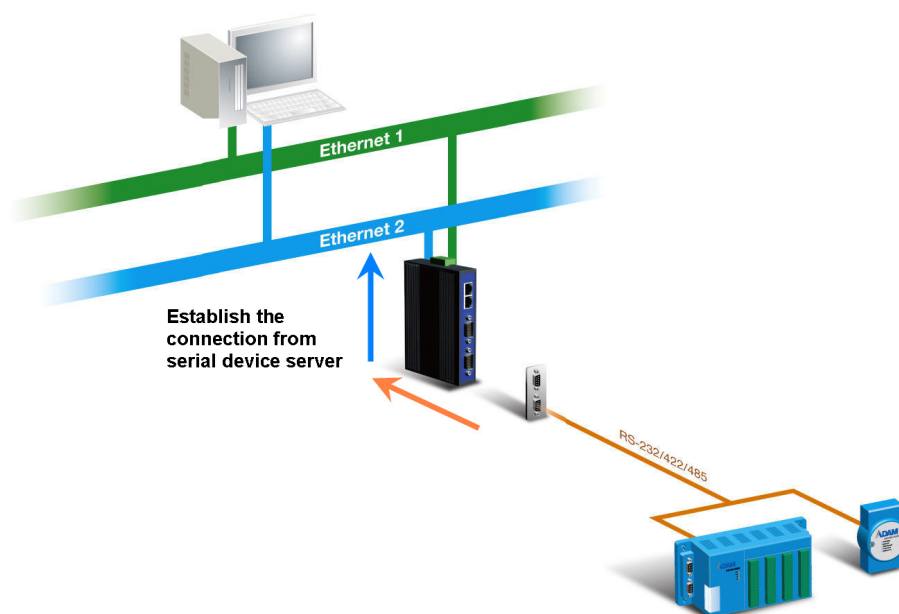

Figure 2.5 TCP Client Mode

2.1.5 Serial Tunneling Mode

Two native serial devices can communicate over an Ethernet network without any intermediate host PC and software programming. Serial Tunneling is very simple to use. You can use Advantech Serial Device Server Configuration Utility to designate one serial port as the tunneling master and another serial device server port as the tunneling slave.

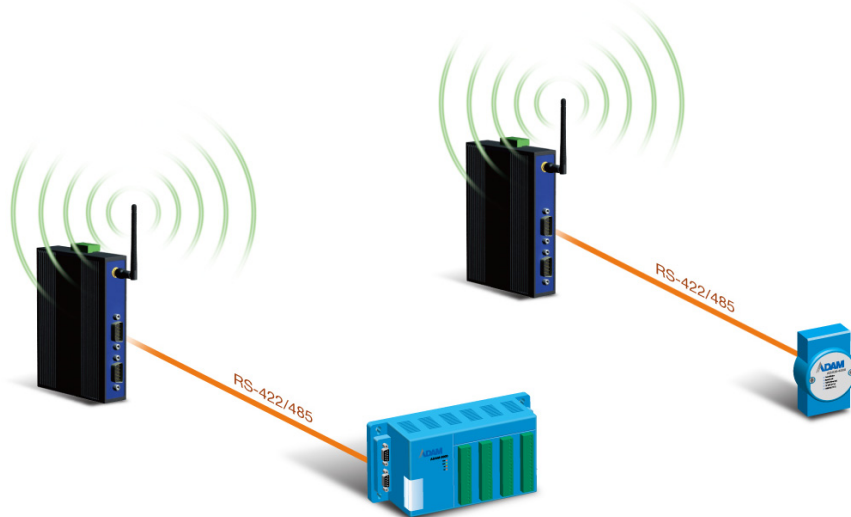

Figure 2.6 Serial Tunneling Mode

2.1.6 UDP Server/Client Mode

UDP is used primarily for broadcasting messages over a network. In the UDP server mode, EKI-1351/1352 access max. of 8 hosts' UDP message. In the UDP client mode, EKI serial device servers transmit UDP message to max. of 4 hosts simultaneously.

2.1.7 Control Mode

In controlling mode, the EKI serial device server presents a modem interface to the attached serial device: it accepts AT-style modem commands to connect / disconnect to other networking device. If you want serial device running application program to connect/disconnect to different devices by request, you can use controlling mode.

The controlling mode provides three kinds of modem AT-style commands. The serial devices can use these commands to control EKI-1351/1352 connecting or disconnecting to remote networking devices. Thus intelligent serial devices such as stand-alone PLC will send /receive data to/from devices one by one via Ethernet.

2.2 Hardware

In this section, we will give you an overview of EKI-1351/1352 hardware and installation.

2.2.1 LED Indicators

There are LEDs display the power status, network status, and serial communication status located on the front panel of EKI-1351 and EKI-1352, each of them has its own specific meaning as below.

Table 2.1: EKI-1351/1352 LED Indicators

LED Name	LED Color	LED Description
P1	Green	Power 1 is on.
	Off	Power 1 is off, or power error condition exists.
P2	Green	Power 2 is on.
	Off	Power 2 is off, or power error condition exists.
Status	Orange	Blinking: System is ready. Steady on: The device server has been located by utility's location function.
	Off	System is not working.
WLAN Signal Strength	Off	0~25% WLAN signal strength.
	Green (One)	25~50% WLAN signal strength.
	Green (Two)	50~75% WLAN signal strength.
	Green (Three)	75~100% WLAN signal strength.
Fail	Off	WLAN module OK.
	Orange	WLAN module failure.
Link/Active	Off	There is no link between EKI and wireless AP.
	Green	Steady on: Has good link to wireless AP. Blinking: WLAN port is transmitting or receiving data.
Serial	Orange	Serial port is transmitting data.
	Green	Serial port is receiving data.
	Off	No data is transmitted or received through the serial port.

2.2.2 Dimensions (Units: mm)

2.2.2.1 EKI-1351 and EKI-1352

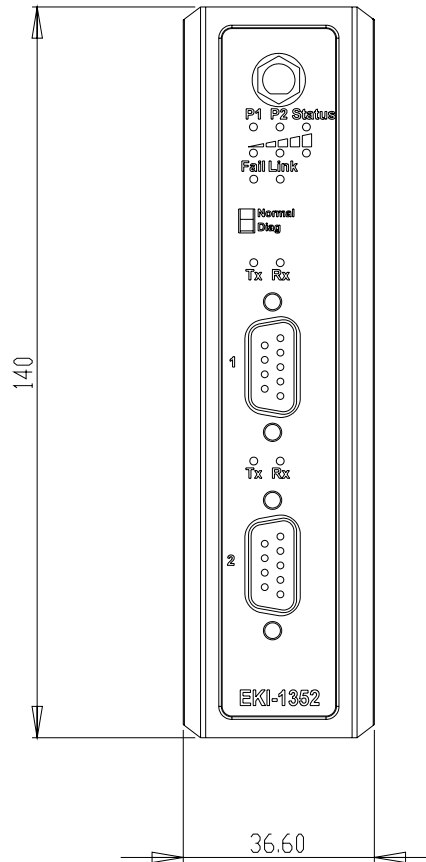

Figure 2.7 Front View of EKI-1351/1352

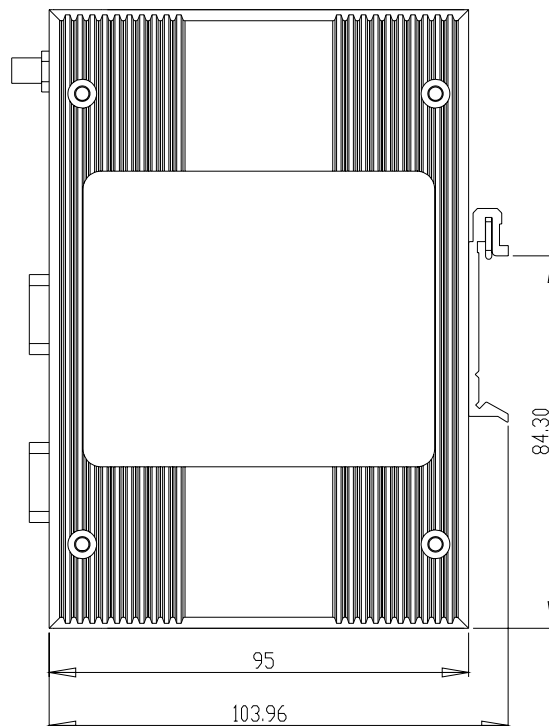

Figure 2.8 Side View of EKI-1351/1352

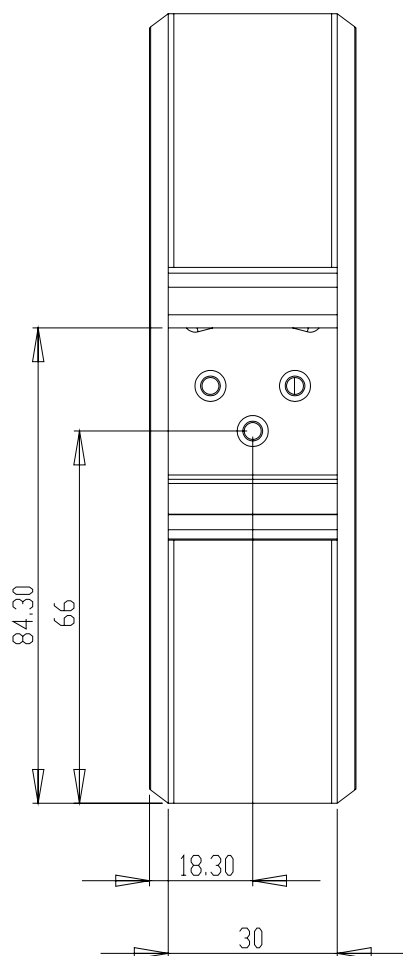

Figure 2.9 Back View of EKI-1351/1352

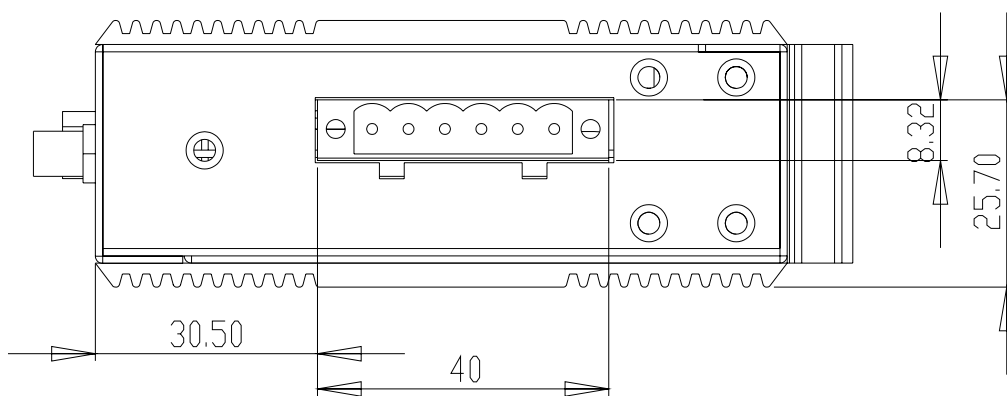

Figure 2.10 Top View of EKI-1351/1352

2.3 Connecting Hardware

Next, we will explain how to find a proper location for your EKI-1351/1352, and then explain how to connect to the network, hook up the power cable, and connect to the EKI-1351/1352 serial port.

2.3.1 Choosing the Location

Due to its versatility and innovative design, EKI serial device server can be:

- Fixed to a panel mount
- Fixed to a DIN-rail.

2.3.2 Panel/Wall Mounting

The EKI-1351/1352 can be attached to a wall using the included metal brackets. Each bracket comes with four screws; and then you can install the device firmly via the components, please see the figure as below.



Figure 2.11 Combine the Metal Mounting Kit

2.3.3 DIN-rail Mounting

You can mount the EKI-1351/1352 on a standard DIN rail. The DIN-rail kit is screwed on the serial device server when out of factory. If the DIN-rail kit is not screwed on the serial device server, please screw the DIN-rail kit on the serial device server first.

First, hang the EKI-1351/1352 to the DIN-rail with angle of inclination. See below.

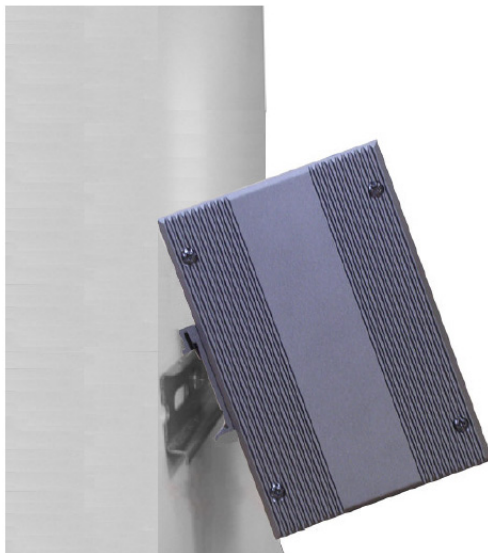

Figure 2.12 DIN-rail Step 1

Then, let the device down straight to slide over the rail smoothly.



Figure 2.13 DIN-rail Step 2

2.3.4 Switch Settings

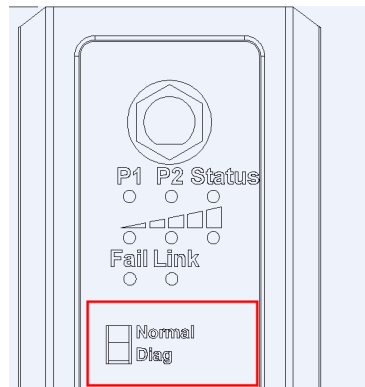

Normal Mode (Normal)

In normal use, you should move the switch to Normal Mode (Normal), and use the configuration utility to configure EKI-1351/1352 for different BSS --- Infrastructure mode or Ad hoc mode.

Diagnostic Mode (Diag.)

If your network connection is broken or you forgot your WLAN serial device server settings, or you forgot the WEP key, you can move the switch to Diagnostic Mode (Diag) to rebuild the settings and connection. The default settings in the Diagnostic Mode as Table 2.2 are fixed. You can connect the host PC and the WLAN serial device server by the default settings, and then you can reset all the network parameters. After rebooting the system, the parameters you set will be applied into **Normal Mode**. All the modifications will not affect the default settings of Diagnostic Mode. That means you can always see the same settings while you enter the Diagnostic Mode every time.

Table 2.2: Default Settings of Diagnostic Mode

	Diagnostic Ad Hoc Mode	Diagnostic Infrastructure Mode
SSID	WLAN	ANY
Channel	10	N/A
WEP	None	None
Enter Way	1. Power off 2. Put the switch at Diagnostic Mode 3. Power on and wait for 6 to 10 seconds for rebooting, then the WLAN serial device server will be in Diagnostic Ad Hoc Mode	1. Power off 2. Put the switch at Normal Mode 3. Power on and wait for 6 to 10 seconds for rebooting 4. Put the switch to the Diagnostic Mode, and then wait for about 5 seconds until the signal LED will start to flash for 10 seconds. During the 10 seconds interval, you have to put the switch back to Normal Mode, and the WLAN serial device server will reboot to Diagnostic Infrastructure Mode. (*Note: If you don't put the switch back to Normal Mode during the 10 seconds interval, the WLAN serial device server will reboot to Diagnostic Ad Hoc Mode.)

Note! Please refer to Appendix A “Quick Start” if setting or resetting the wireless connection



2.3.5 Wireless Connection

EKI-1351 and EKI-1352 operate in the 802.11b/g WLAN environment, which is created by an access point working with 802.11b/g protocols. Locate your access point and connect to the Ethernet network first. Then build up the connection between the access point and the EKI-1351 and EKI-1352 (Refer to Appendix A “Quick Start”). While the host PC can not connect to EKI-1351 and EKI-1352, you might switch the EKI-1351/1352 as Diag. (Diagnostic) mode.

- Set the switch of EKI-1351/1352 to Normal mode, then power on.
- Wait for 10 to 20 seconds until the signal quality is stable.
- Adjust the switch to Diag. mode, and then wait for about 5 seconds until the signal strength LED is blinking.
- Return the switch to Normal mode, EKI-1351/1352 will reboot automatically with diagnostic infrastructure mode. Now EKI-1351/1352 will search the filed site for access points and create the connection to the one with best signal strength.
- Start the configuration utility tool on your host PC (ensure your host PC and the possible access point the EKI-1351/1352 can connect to, are in the same network domain). Find the EKI-1351 or EKI-1352 on the network.
- Reset the network setting as required. (About network settings, please refer to next chapter of the manual)

After the connection is ready, you can follow the steps shown in chapter 3 to configure and virtual COM port mapping through network and access point.

You can check the signal access strength with the WLAN signal strength LED indicators. Adjust the antenna of the EKI serial device server to optimize communication quality.

2.3.6 Power Connection

The EKI-1351/1352 supports dual 12 to 48 VDC power inputs and power-fail relay output.

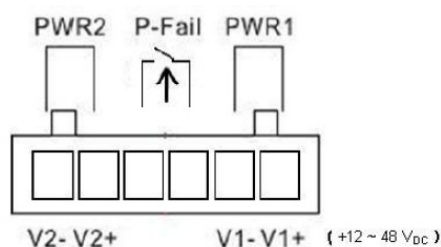

Figure 2.14 Power Connector

You can connect an alarm indicator, buzzer or other signaling equipment through the relay output. The relay opens if power input 1 or 2 fails (“Open” means if you connect relay output with an LED, the light would be off).

2.3.7 Serial Connection

EKI-1351/1352 provides one or two ports DB9 (male) connectors. RS-232/422/485 pin assignments as below:

Male DB9 (DB9-M)

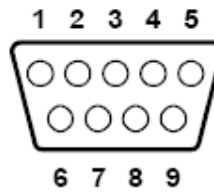

Table 2.3: EKI-1351/1352 Serial Pin Assignments

Pin	1	2	3	4	5	6	7	8	9
RS-232	DCD	RX	TX	DTR	GND	DSR	RTS	CTS	RI
RS-422	TX-	-	-	TX+	GND	-	RX+	-	RX-
RS-485	DATA-	-	-	DATA+	GND	-	-	-	-

2.4 Serial Device Server Configuration Utility

Advantech Serial Device Server Configuration Utility integrates device server management and virtual COM port mapping utility. After installation, this utility not only configures the EKI-1351/1352, but also connects and configures the ADAM series and EDG series device servers. Virtual COM port configuration and management was also integrated in this utility. The best improvement, you don't restart the host computer while you setup new virtual COM ports. When you map the virtual COM port, the COM port will enable immediately and show in Windows Device Manager.

In order to use a PC and an Ethernet network to control serial devices connected to the EKI-1351/1352, you must first have a host running Windows 2000/XP/Vista. This type of application also requires the host to have an Ethernet card and the TCP/IP protocol installed. The following are the installation instructions to set up the Serial Device Server Configuration Utility:

Note! Be sure Microsoft .NET Framework on host PC is greater than version 2.0.



1. Insert the Advantech IEDG SERIES DRIVER UTILITY CD-ROM into the CD-ROM drive (e.g. D:\) on the host PC.
2. Use Windows Explorer or the Windows Run command to execute the Configuration Utility setup program. If your CD-ROM is D:\, the path for the setup program will be: D:\Utility&Driver\Serial Device Server Configuration Utility\Serial_Device_Server_Configuration_UTILITY_[Version]_Release_[ReleaseDate].exe
3. Upon executing the setup program, the welcome dialogue window will be pop-up. Press the "Next" button to continue the process.

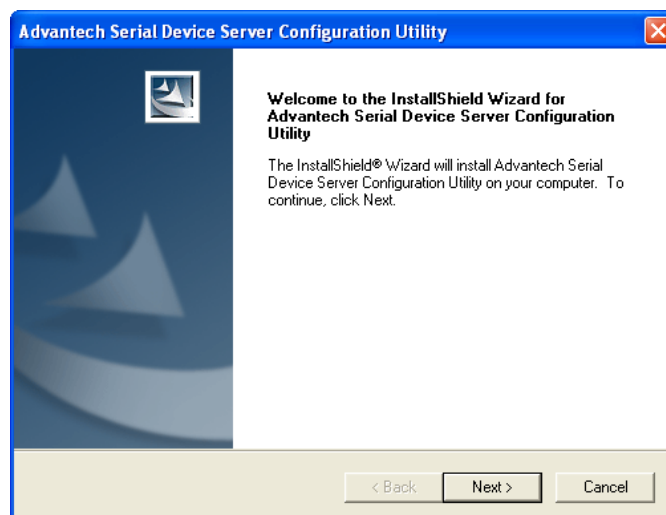

4. Carefully read the Software License Agreement, and press “Yes” to continue the process.

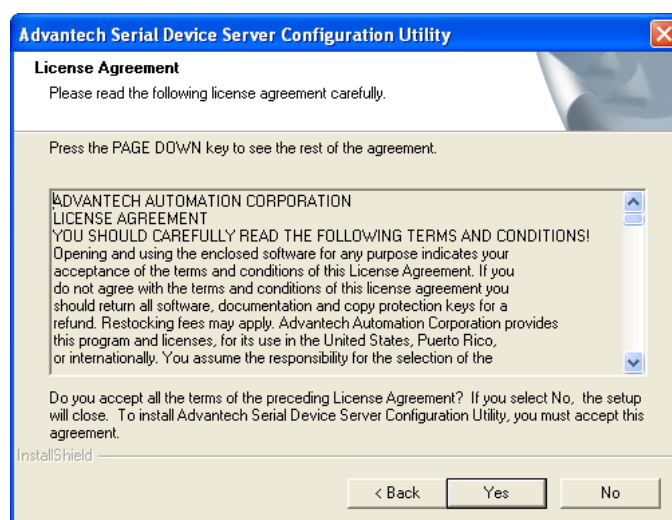

5. The setup program will specify a default installation path: C:\Program Files\Advantech eAutomation\Serial Device Server Configuration Utility, press “Install” button to continue the process.

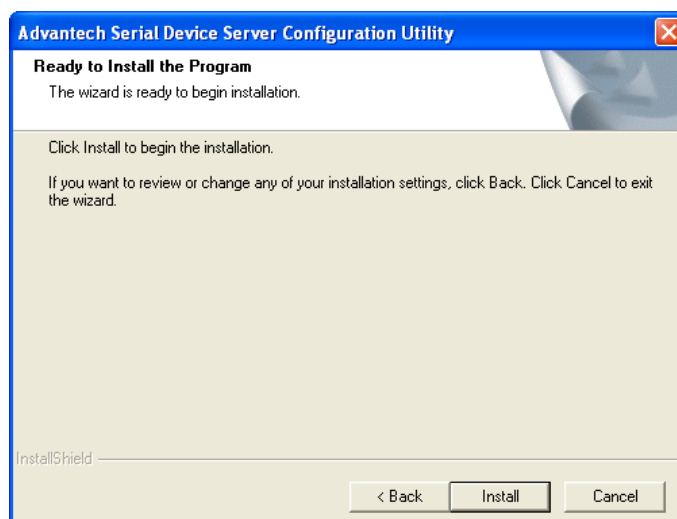

6. After setup program has copied all program files to your computer, press “Finish” button for completing the installation process.

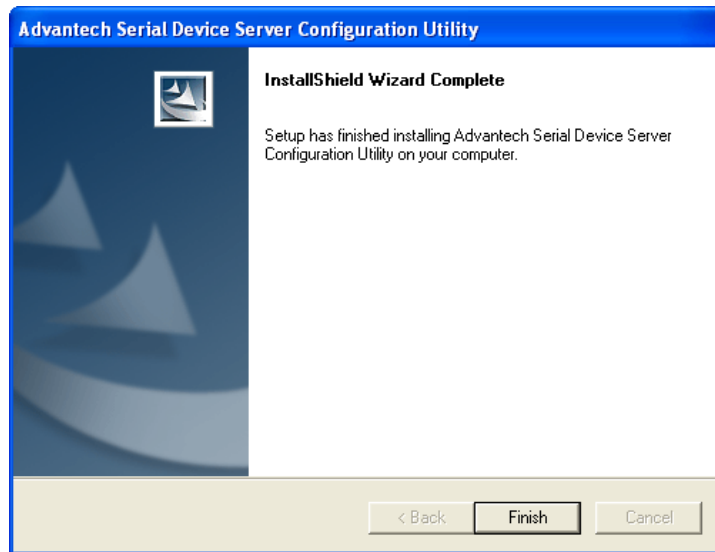

Chapter 3

Configuration

3.1 Configuration Utility Overview

EKI-1351/1352 provides an easy-to-use configuration utility to configure your serial device server through an Ethernet connection. For secure administration, it can also restrict the access rights for configuration to only one host PC to enhance network security. With this secure function enabled, other PCs will not have permission for configuration. After the installation program on the Advantech IEDG Series Driver Utility CD-ROM is finished, the serial device servers will be ready for use and configure.

Advantech Serial Device Server Configuration Utility is an excellent device server management tool. You can connect and configure the local and remote Advantech serial device servers easily. Moreover, Virtual COM port will be enabled in the same utility. Using this utility, you can:

- Configure the network settings (you can set the IP address, Gateway address, and Subnet mask)
- View and set the serial port parameters (configure operating mode, baud rate, serial port settings and operating mode settings)
- Perform diagnostic tests (virtual COM port testing, port status list)
- Perform administrative functions (export and import the serial device server setting, manage access IP, a descriptive name, upgrade firmware)
- Configure COM port redirector(virtual COM port)

There are four major areas in this new serial device server configuration utility.

1. Device Server List Area: All devices will be searched and listed in this area. You can arrange different favorite group and virtual COM ports.
2. Device Server Information Area: Click on the serial device server or move cursor to the serial device server, the related information will be shown on this area.
3. Configuration Area: Click on the item on the Device Server List Area, the configuration page will display on the area.
4. Quick Tool Area: Useful management functions shortcut.

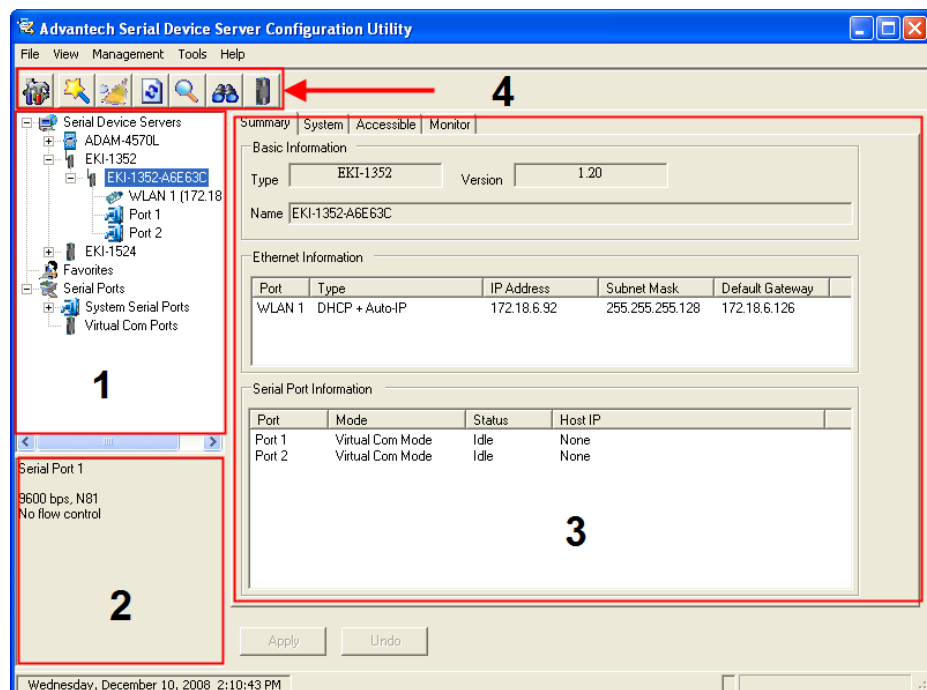

3.2 Discovering Serial Device Servers

3.2.1 Auto Searching

Advantech Serial Device Server Configuration Utility will automatically search all the EKI, ADAM and EDG series device servers on the network and show them on the Device Server List Area of the utility. The utility provides an auto-search function to show your device(s) by simply executing the configuration utility program from the Start Menu as follows: **Start Menu --> All Program --> Advantech eAutomation --> Serial Device Server Configuration Utility**



From here all device on the same network domain will be searched and display on Device Server List Area. You can click on the device name to show the features of the specific device. Click on the "+" before the model name, and the utility will expand the tree structure to show the individual device name. Click on the "-" before the model name, and the utility will collapse the tree structure.

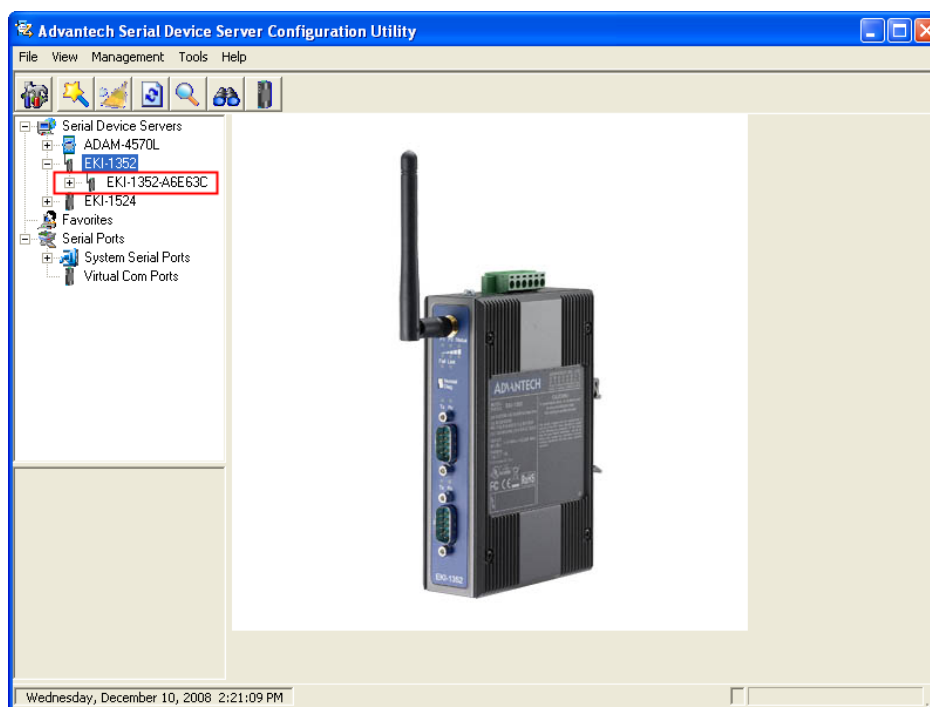

For Example, EKI-1352 in this figure is shown "EKI-1352-A6E63C" after expanding the tree structure.

Note *When you run the Configuration Utility for the first time, the default device name is "MAC ID". In this case, the device name "EKI-1352-A6E63C" means the device "MAC ID" is "00 D0 C9 A6 E6 3C". You can change the default device name in System Tab of Device Properties.*

Select the device in this sub-tree. The first tab on the "Configuration Area" shows the summary of "Basic Information" included device Type, version, and name, "Ethernet Information", and "Serial Port Information". In the serial port information frame, it displays the operation mode, status and connected host IP.

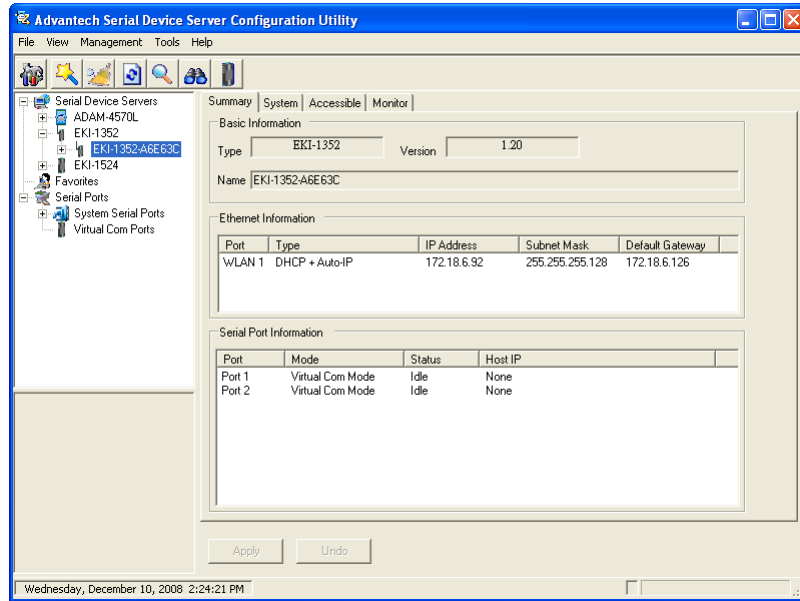

Click on the “+” before the device name, and the utility will expand the interfaces on this device server.

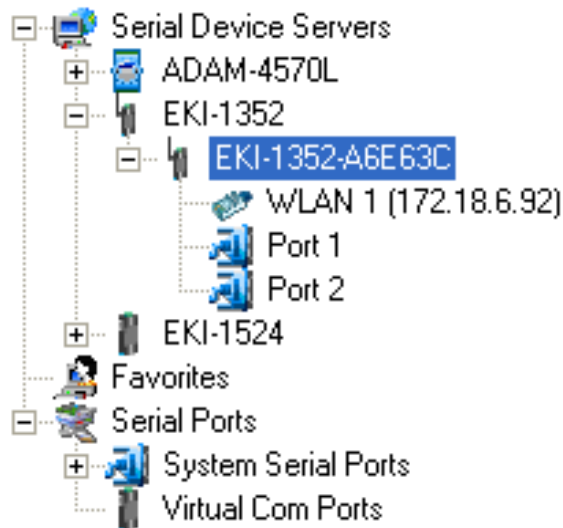

Click on each item, you will enter the configuration page to change the setting. The configuration will be introduced on following sections.

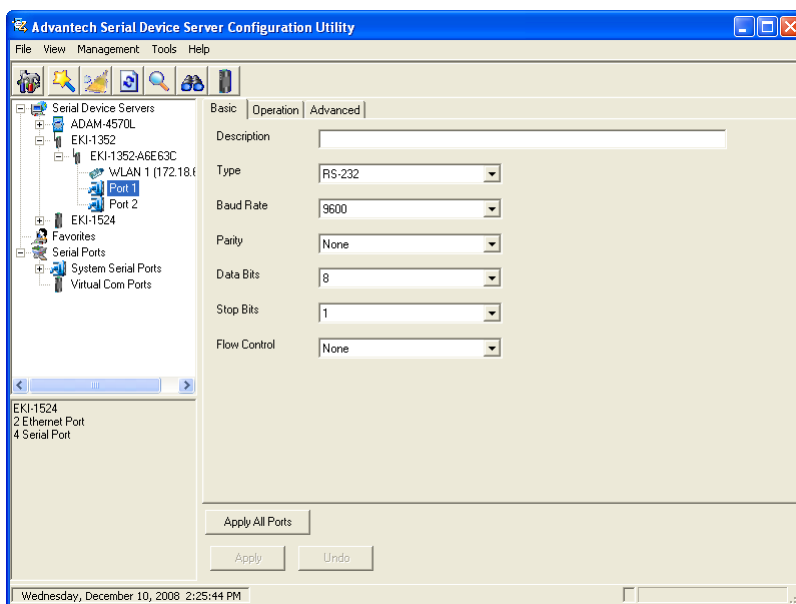
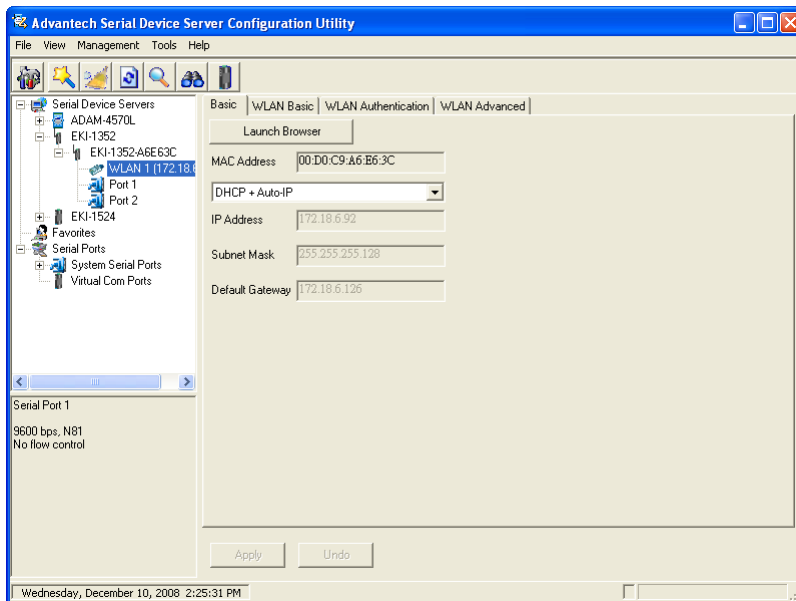

3.2.2 Clear Device List and Search Again

You can click the  button on the “Quick Tool Area”; utility will clear all list device servers in the Device Server List Area and re-search again. Don't use this function frequently. The warning message will be pop-up when you double click this button.



You can click the  button on the “Quick Tool Area”; utility will search serial device server on local LAN.

3.2.3 Manual Appending

Using “Add IP address to Favorite” or “Search a Range of IP addresses” function, you are able to add one device or group of devices to “Favorites”. These devices can locate on local network domain or other network domain.

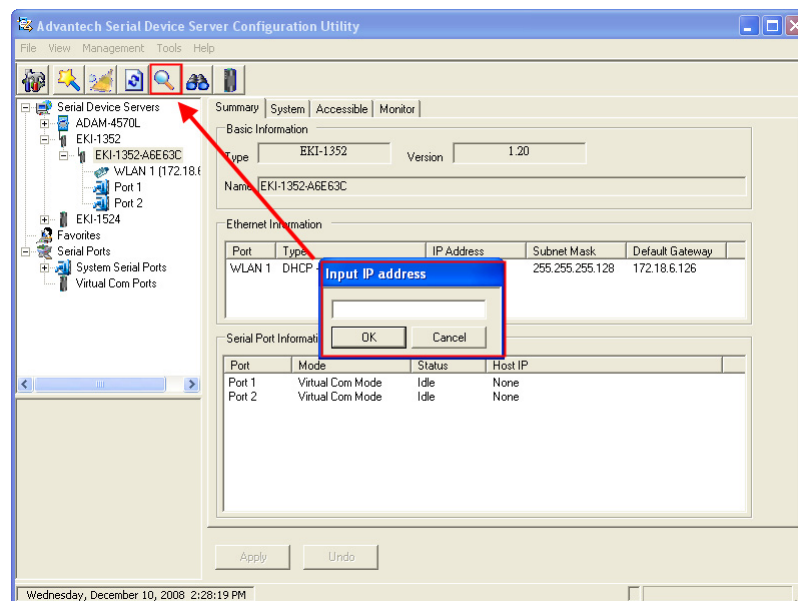

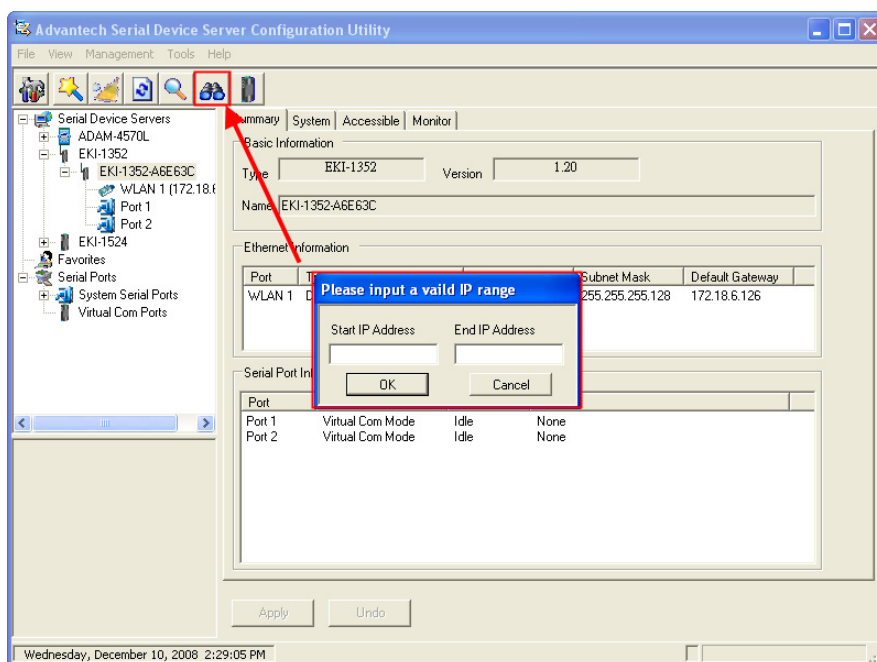

3.3 Network Settings

This section explains how to configure the EKI-1351/1352 series network using this utility so that it can communicate over a network with serial devices.

Click on the “+” before the model name (e.g. EKI-1352), and the utility will expand the tree structure to show the individual device name. And click on the “+” before the device name, and the utility will expand the interfaces on this device server. Select the Ethernet interface.

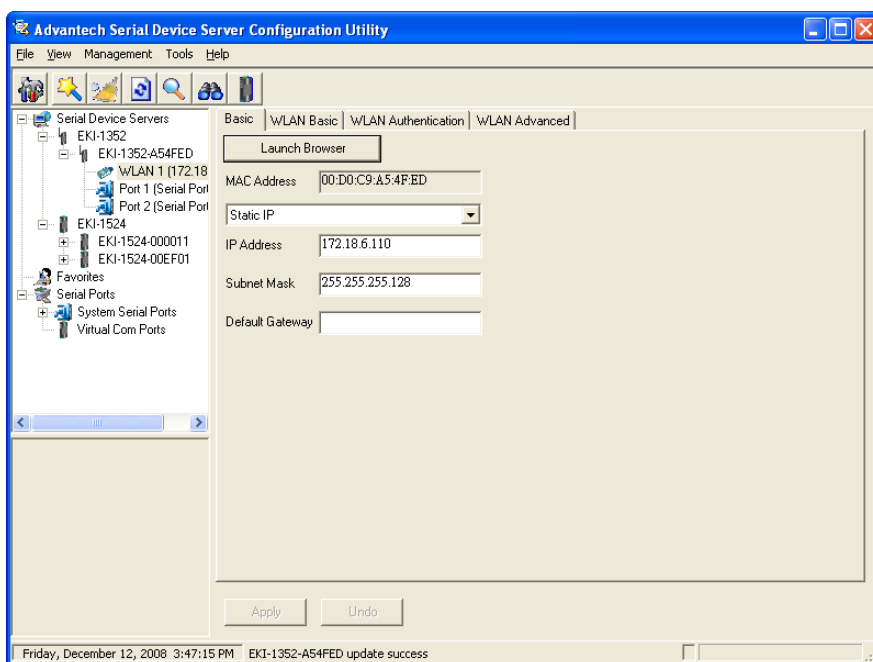

MAC address:

The MAC address is for the local system to identify and locate each serial device servers. This MAC address is already set before delivery from factory, hence no need for further configuration.

IP address, Subnet Mask, Default Gateway:

You can choose from four possible IP Configuration modes --- **Static** or **DHCP**.

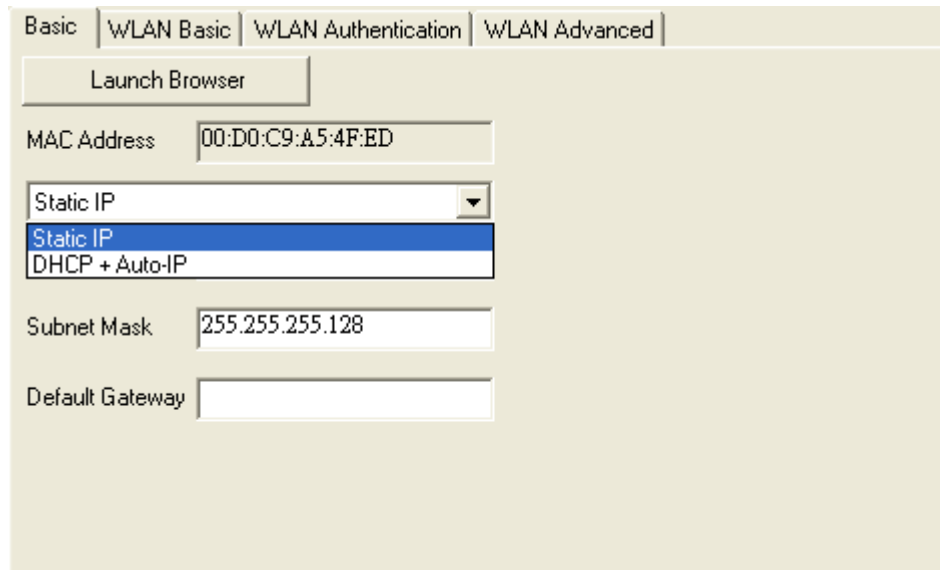

The screenshot shows a configuration interface with the following elements:

- Navigation tabs: Basic, WLAN Basic, WLAN Authentication, WLAN Advanced.
- Launch Browser button.
- MAC Address field: 00:D0:C9:A5:4F:ED.
- IP Configuration mode dropdown menu with options: Static IP (selected), Static IP, DHCP + Auto-IP.
- Subnet Mask field: 255.255.255.128.
- Default Gateway field: (empty).

Static IP

User defined IP address, Subnet Mask, and Default Gateway.

DHCP + Auto-IP

DHCP Server assigned IP address, Subnet Mask, Default Gateway, and DNS.

Note!



When you have finished the configuration of these settings for each category, please press the "Apply" button in order to make these settings effective on the Serial Device Server. (Will reboot your Serial Device Server immediately)

3.3.1 Wireless Basics

3.3.1.1 Wireless Basic Information

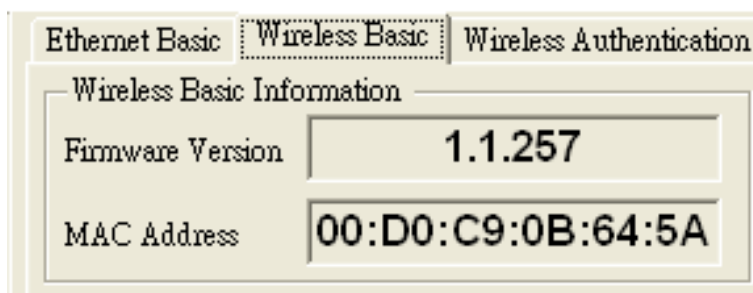

Wireless Basic Information	
Firmware Version	1.1.257
MAC Address	00:D0:C9:0B:64:5A

- I Firmware Version: Here is the firmware version of the wireless module embedded in the EKI-1531 and EKI-1352. The wireless module firmware might affect the wireless connection. Write down the version number and provide to our customer service if you have wireless connection problems.
- I MAC Address: The MAC address is for the local system to identify and locate each serial device servers. This MAC address is already set before delivery from factory, hence no need for further configuration.

3.3.1.2 Association Information

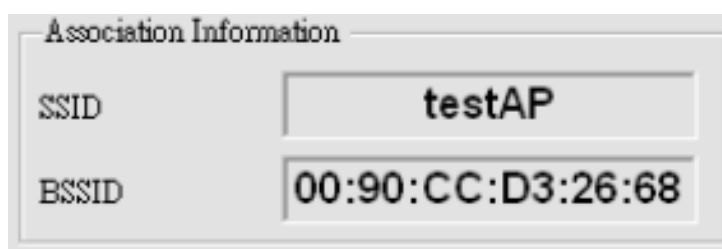

Association Information	
SSID	testAP
BSSID	00:90:CC:D3:26:68

- I SSID: The SSID (Service Set Identity) identifies a specific wireless LAN. Before associating with a particular wireless LAN, a station must have the same SSID as its access point. This field shows the AP that the EKI-1351 or EKI-1352 is connecting. That means the user must set the specific access point's SSID in infrastructure networks, or set the same SSID in ad hoc networks.
- I BSSID: Normally, it should be the MAC Address of Access Point.

3.3.1.3 Wireless Basic Settings

- | Region: Set the region. Each region has its default channel range. When you choose a specific region, the optional channel range and numbers in the below drop-down menu will be changed automatically.

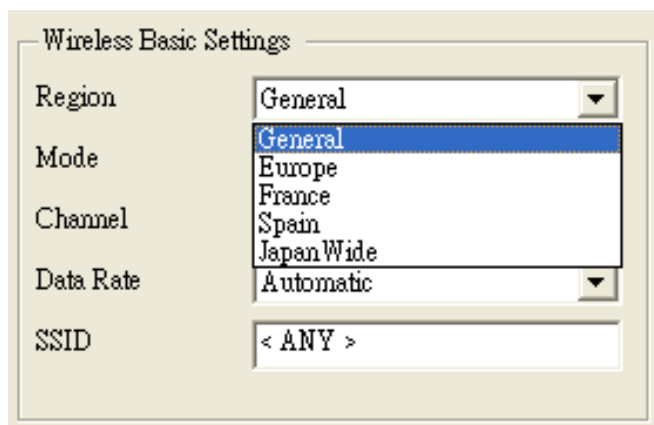

- | Mode: There are two kinds of basic service set (BSS) in this drop-down menu.

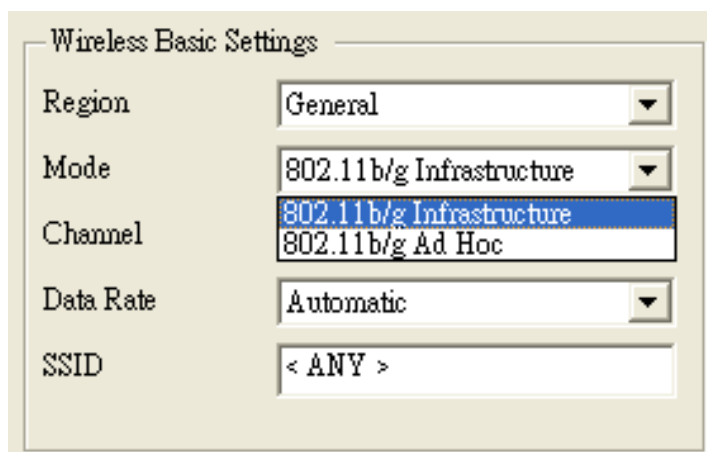

- | 802.11b/g Infrastructure mode : For infrastructure BSS usage, you should set up the SSID of the specific access point (AP). Or just choose .ANY. in SSID drop-down menu to let the wireless module automatically search and connect the appropriate AP.
- | 802.11b/g Ad hoc mode: For point-to-point connection, specific or independent BSS usage, you should set the same channel and the same SSID for both points.
- | Channel: Each region has its default channel range, which is decided by each region's telecommunications laws.

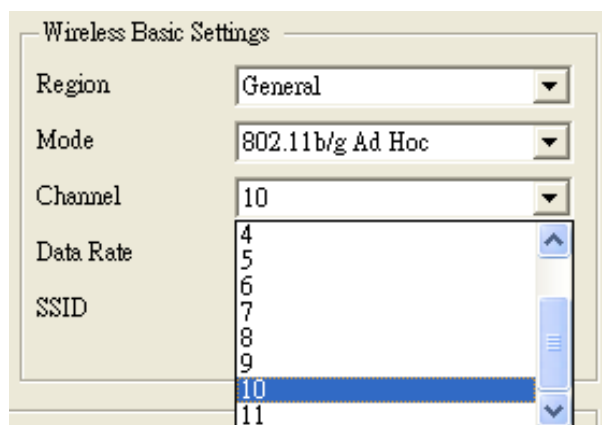

- I Data Rate: The data transmission rate is determined by the device and access point. If there is a restriction for the device or AP, a fixed data rate has to be chosen. Otherwise, we suggest the “Automatic” choice.

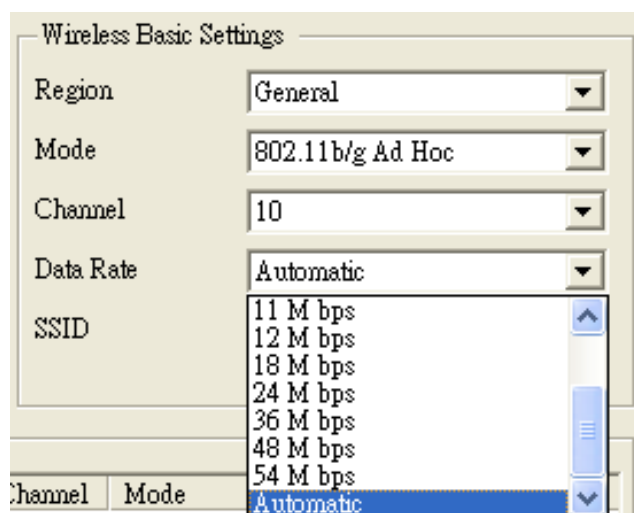

- I SSID: You can input the AP SSID here. If you doesn't know which access point is the most appropriate one, just set "ANY" for an automatic search.

3.3.1.4 Site Survey

The site survey lists information about the access points that EKI-1351 and EKI-1352 could find when “Serial Device Server Configuration Utility” started. You should press “Refresh Site List” button to update the site survey data.

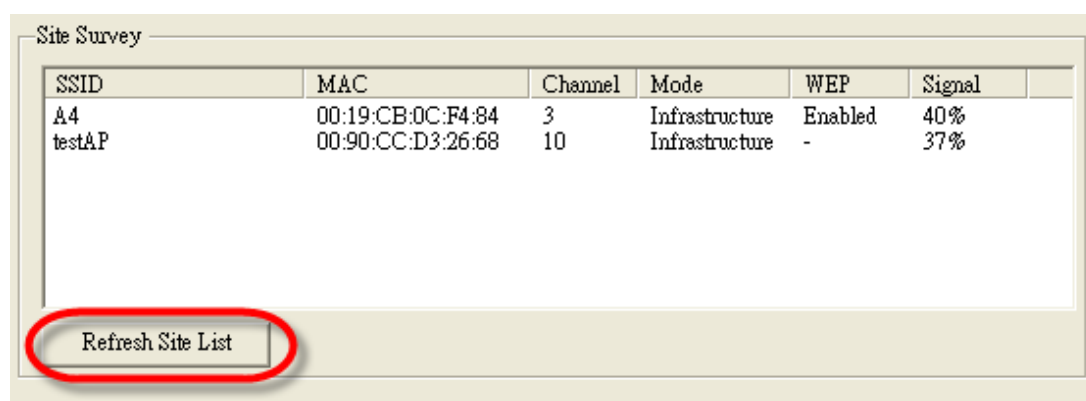

3.3.2 Wireless Authentication

EKI-1351 and EKI-1352 now support WEP (Wired Equivalent Privacy) encryption operation mode. WEP is a kind of standard to encrypt the data frame. We will enhance other encryption mode in future.

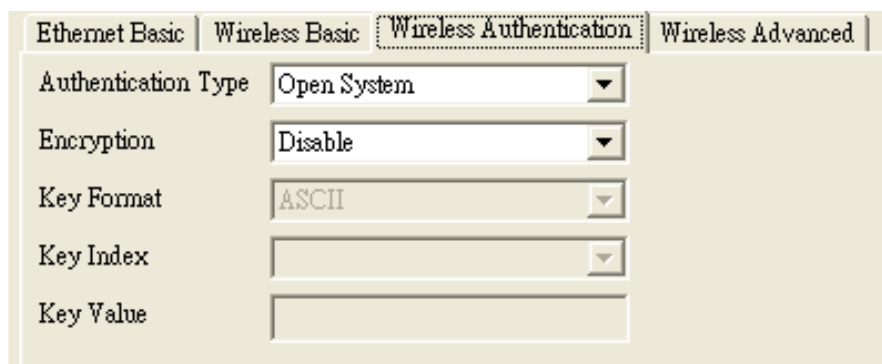

- | Authentication Type: There are three kinds of types in this drop-down menu.

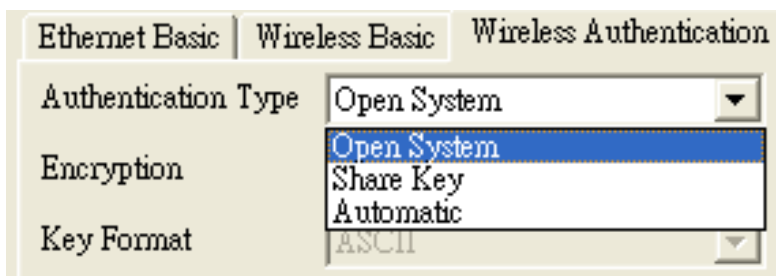

- | Open System: No encryption for network communication. You can neglect the key setting on the right side.
 - | WEP Share Key: Both communication devices use the same key as encryption.
 - | Automatic: Detect the WEP situation of the access point automatically. EKI-1351 and EKI-1352 will use the current key for encryption. If EKI-1351/1352's key does not coincide with the access point's key, the user should reset the same key and reboot to connect.
- | Encryption: If the system needs WEP encryption, the user has to set the key type. There are two kinds of encryption keys: 64 bits and 128 bits. For an open system, the encryption function is disabled.

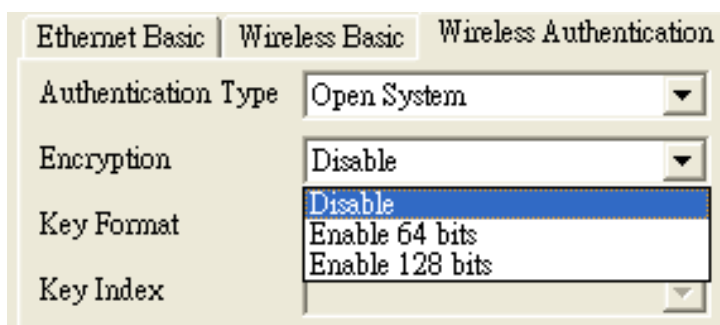

- | Key Format: The table shows the allowed characters and length of the different key index and key formats.

Ethernet Basic	Wireless Basic	Wireless Authentication
Authentication Type	Open System	
Encryption	Enable 64 bits	
Key Format	ASCII	
Key Index	<div style="border: 1px solid black; padding: 2px;"> ASCII Hexadecimal </div>	

	Alphanumeric	Hexadecimal
64 bits	Up to 5 random characters on the keyboard	Up to 10 random hexadecimal characters (0 ~ 9, a ~ f)
128bits	Up to 13 random characters on the keyboard	Up to 26 random hexadecimal characters (0 ~ 9, a ~ f)

- I Key Index: This lists the supported encryption keys that you can choose from

Ethernet Basic	Wireless Basic	Wireless Authentication
Authentication Type	Open System	
Encryption	Enable 64 bits	
Key Format	ASCII	
Key Index	Key 1	
Key Value	<div style="border: 1px solid black; padding: 2px;"> Key 1 Key 2 Key 3 Key 4 </div>	

- I Key Value: You can set up the key value in this index.

Ethernet Basic	Wireless Basic	Wireless Authentication
Authentication Type	Open System	
Encryption	Enable 64 bits	
Key Format	ASCII	
Key Index	Key 1	
Key Value	Value	

3.3.3 Wireless Advanced

The tab identifies several parameters that are related to the 802.11b/g wireless network. We strongly suggested the default settings are not changed unless necessary. If you want to recovery to factory value, you click the “Reset to factory default value”.

Parameter Name	Value
Beacon Interval	100
RTS Threshold	2432
Fragment Threshold	2346
Preamble Type	Long

Reset to factory default value

Parameters	Default Value	Range
Beacon Interval	100	0~65535
RTS Threshold	2347	0~2347
Fragment Threshold	2346	256~2346
Preamble	Long	Long/Short

3.3.3.1 Beacon Interval

In infrastructure networks, the access point periodically sends beacons. You can set the beacon interval with the access point configuration screen. In general, the beacon interval is set to 100 ms, which provides good performance for most applications.

In ad hoc networks, there are no access points. As a result, one of the peer stations assumes the responsibility for sending the beacon. After receiving a beacon frame, each station waits for the beacon interval and then sends a beacon if no other station does so after a random time delay. This ensures that at least one station will send a beacon, and the random delay rotates the responsibility for sending beacons.

By increasing the beacon interval, you can reduce the number of beacons and associated overhead, but that will likely delay the association and roaming process because stations scanning for available access points may miss the beacons. You can decrease the beacon interval, which increases the rate of beacons. This will make the association and roaming process very responsive; however, the network will incur additional overhead and throughput will go down. In addition, stations using power save mode will need to consume more power because they'll need to awaken more often, which reduces power saving mode benefits.

3.3.3.2 RTS Threshold

RTS Threshold is the frame size above that an RTS/CTS handshake will be performed before attempting to transmit. RTS/CTS ask for permission to transmit to reduce collisions, but add considerable overhead. Disabling RTS/CTS can reduce overhead and latency in WLANs where all stations are close together, but can increase collisions and degrade performance in WLANs where stations are far apart and unable to sense each other to avoid collisions. If you are experiencing excessive collisions, you can try turning RTS/CTS on or (if already on) reduce RTS/CTS Threshold on the affected stations.

3.3.3.3 Fragment Threshold

Fragmentation Threshold is the maximum length of the frame, beyond which payload must be broken up into two or more frames. Collisions occur more often for long frames because sending them occupies the channel for a longer period of time, increasing the chance that another station will transmit and cause a collision. Reducing Fragmentation Threshold results in shorter frames that "busy" the channel for shorter periods, reducing packet error rate and resulting retransmissions. However, shorter frames also increase overhead, degrading maximum possible throughput, so adjusting this parameter means striking a good balance between error rate and throughput.

3.3.3.4 Preamble Type

A preamble is a signal used in network communications to synchronize the transmission timing between two or more systems. Proper timing ensures that all systems are interpreting the start of the information transfer correctly.

3.4 Serial Settings

This section explains how to configure EKI-1351/1352 serial communication parameters using this utility. There are various operation modes that are suitable for different application.

Click on the "+" before the model name (e.g. EKI-1522), and the utility will expand the tree structure to show the individual device name. And click on the "+" before the device name, and the utility will expand the interfaces on this device server. Select the serial interface.

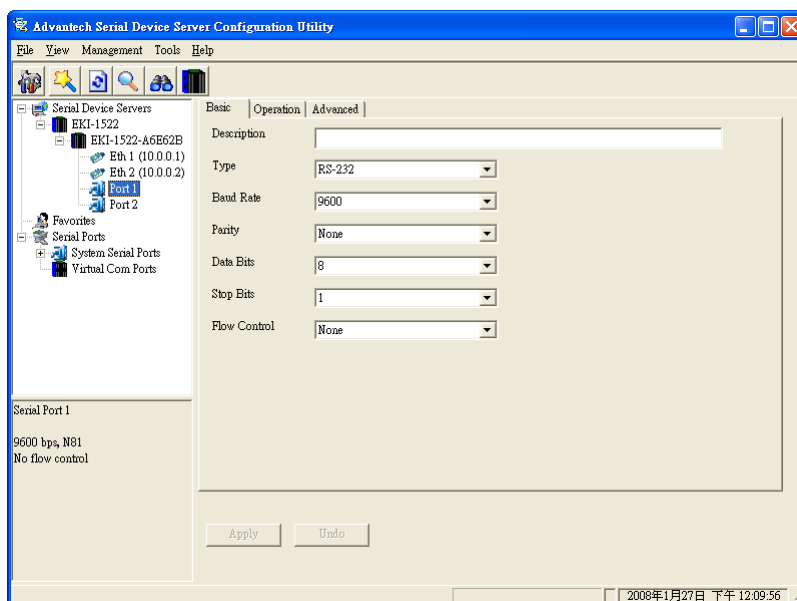

3.4.1 Setting Serial Port Parameters

- Description: You can give a more detailed description on the function of the port for easier management and maintenance. Descriptions have a limit of 128 characters.

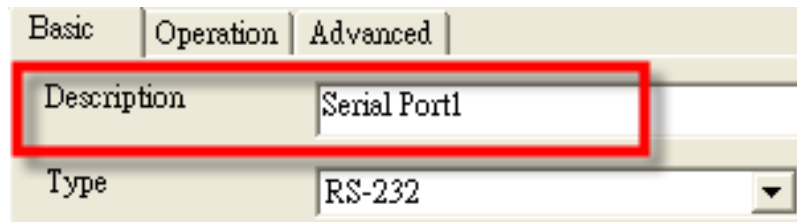

The screenshot shows a configuration window with three tabs: Basic, Operation, and Advanced. The Basic tab is selected. The Description field is highlighted with a red rectangle and contains the text "Serial Port1". Below it, the Type dropdown menu is set to "RS-232".

- Type: The EKI-1351/1352 offers three kinds of serial protocols, RS-232, RS-422 and RS-485. You can use any of these three serial protocols according to your requirements.

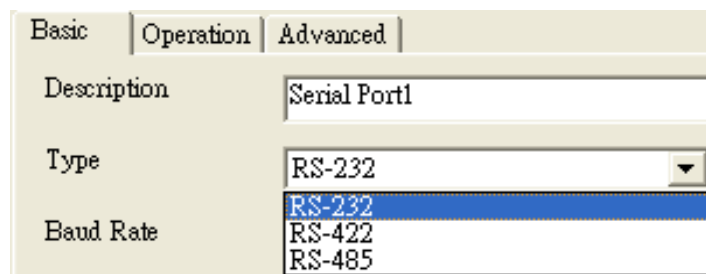

The screenshot shows the configuration window with the Type dropdown menu expanded. The menu lists three options: RS-232 (highlighted in blue), RS-422, and RS-485. The Description field contains "Serial Port1".

- Baud Rate: The EKI-1351/1352 supports baud rate from 50 to 921.6Kbps. Total throughput up to 1.2M bps

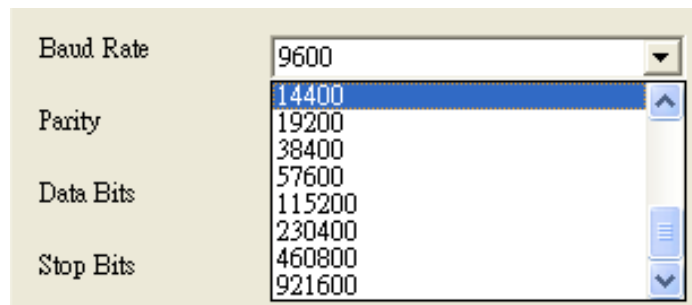

The screenshot shows the configuration window with the Baud Rate dropdown menu expanded. The menu lists several options: 9600, 14400 (highlighted in blue), 19200, 38400, 57600, 115200, 230400, 460800, and 921600. The Description field contains "Serial Port1" and the Type dropdown is set to "RS-232".

- Parity: The EKI-1351/1352 provides five options: None, Odd, Even, Space, and Mark.

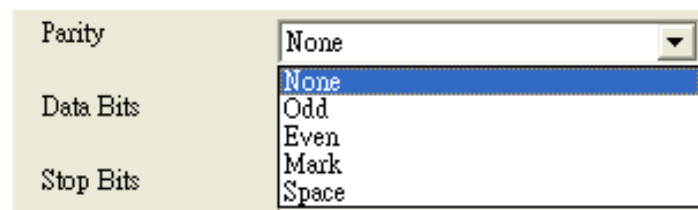

The screenshot shows the configuration window with the Parity dropdown menu expanded. The menu lists five options: None (highlighted in blue), Odd, Even, Mark, and Space. The Description field contains "Serial Port1" and the Type dropdown is set to "RS-232".

- Data Bits: The EKI-1351/1352 provides four options: 5, 6, 7 and 8.

A configuration window with three rows. The first row is 'Data Bits' with a dropdown menu showing '8'. The second row is 'Stop Bits' with a dropdown menu showing '5', '6', '7', and '8'. The third row is 'Flow Control' with a dropdown menu showing 'None'.

- Stop Bits: The EKI-1351/1352 provides three options: 1, 1.5 and 2.

A configuration window with two rows. The first row is 'Stop Bits' with a dropdown menu showing '1'. The second row is 'Flow Control' with a dropdown menu showing '1', '1.5', and '2'.

- Flow Control: The EKI-1351/1352 provides four options: None, XOn/XOff, RTS/CTS, and DTR/DSR.

A configuration window with one row. The row is 'Flow Control' with a dropdown menu showing 'None', 'XOn/XOff', 'RTS/CTS', and 'DTR/DSR'.

Note When you have finished the configuration of these settings for each category, please press the “Apply” button in order to make these settings effective on all serial device servers. (Will restart your serial device server immediately)

3.4.2 Setting Virtual COM Operating Mode Parameters

The Advantech serial device servers extend traditional COM ports of a PC to Ethernet access. Through Ethernet networking, users can control and monitor remote serial devices and equipment over LAN or WAN. Advantech serial device servers come with a COM port redirector (Virtual COM driver) that transmits all serial signals intact. This means that your existing COM-based software can be preserved, without modifying to fulfill the needs. The Virtual COM mode allows user to continue using RS-232/422/485 serial communications software that was written for pure serial communication applications.

EKI-1351/1352 comes with COM port redirector (virtual COM driver) that work with Window NT/2000/XP/Vista(X86) systems. The driver establishes a transparent connection between host and serial device by mapping the IP of Advantech serial device server serial port to a local COM port on the host computer.

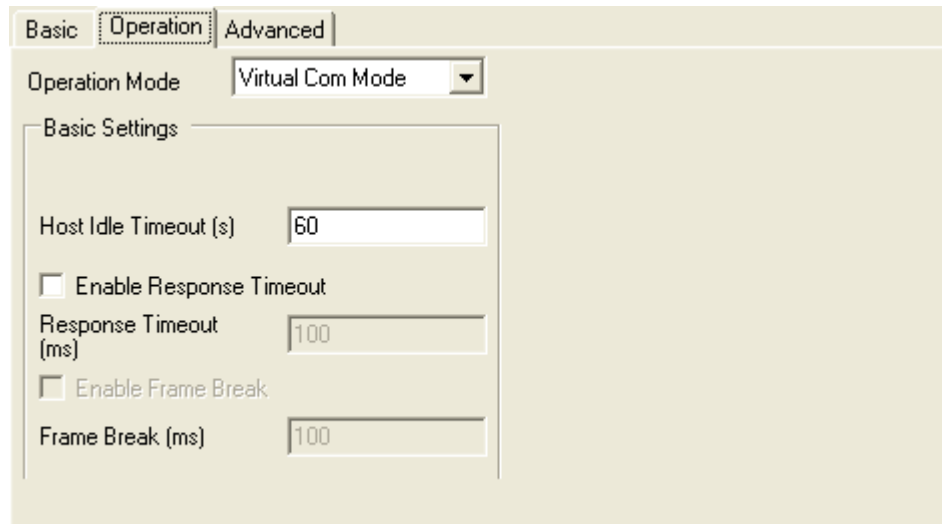

- Host Idle Timeout (10~255 seconds): The "Host Idle Timeout" setting monitors the connection between the host and the device. If the "Host Idle Timeout" setting time is reached, the device server will release the resources allocated to the port mapping. This prevents a stalled host from affecting the connected device.

Note The default value of "Host Idle Timeout" is 255 seconds.

EKI-1351/1352 provides Multi-access function through 802.11b or 802.11g WLAN. Allow the maximum of five connections to open one serial port simultaneously. In the mode, all connections have to use the same serial setting. If one serial setting of these connections is different from others, the data communication may operate incorrectly.

There are two kinds of Multi-access function. One is Normal mode; another is Round-Robin mode.

- Normal mode: Disabling "Response Timeout" parameter, EKI-1351/1352 will operate in "normal mode". When multiple hosts open the serial port simultaneously, the EKI-1351/1352 only offers control ability to the first connected host but also provides data communication function for others. Each serial port supports up to five simultaneous connections, so multiple hosts can transmit/receive data to/from the same serial port simultaneously. Every host can transmit data to the same serial port, and EKI-1351/1352 will also transmit data to every host. But, while multiple hosts transmit data to the same serial port at almost same time (there still have the order of arrival), the received data from serial device (this should be required by the first order of arrival) will be transmitted to the connected hosts simultaneously. This causes hosts receive incorrect data except the host who has the first order of arrival.

Note This operating mode is suitable for the one major host send the command and others hosts just listen the data from serial port. If two of connected hosts send the command at the same time, it is possible that EKI serial device server will not handle the command and will response the incorrect data.

- Round-Robin mode: Enabling “Response Timeout” parameter, the EKI-1351/1352 will operate in “Round-Robin mode”. Each serial port supports up to five simultaneous connections, so multiple hosts can transmit/receive data to/from the same serial port simultaneously. Every host can transmit data to the same serial port simultaneously, but EKI serial device server will process the data communication in order. EKI-1351/1352 will process the first host’s request and reply the response to the first host. If EKI serial device server receives nothing from serial port after a period of time set by user in "Response Timeout" block, the device server will reply the acknowledgement to the host and then process the next host’s request. The cycle time will be increased when you increase either the number of the connected hosts or the value of "Response Timeout".
- Frame Break is a very important parameter for Round Robin mode. This parameter is a smart way to reduce inefficient waiting time and EKI-1351/1352 can transmit data more efficiently. Disabling the Frame Break function, EKI-1351/1352 will wait for data until "Response Timeout" setting time is reached. During this period, the commands from hosts will be queued and EKI-1351/1352 just processes this command. Enabling “Frame Break”, if the serial port idle is longer than the “Frame Break” period, EKI-1351/1352 will assume the communication is completed and continue the next host’s query. This is an efficient way to reduce the waiting time and improve the performance.

3.4.3 Setting TCP/UDP Server/Client Operating Mode Parameters

EKI-1351/1352 provides various operating modes. Selecting the "USDG Mode" as below to change the mode of the port to TCP server/client or UDP mode. Before setting the TCP server mode, you have to check the serial port setting in advance.

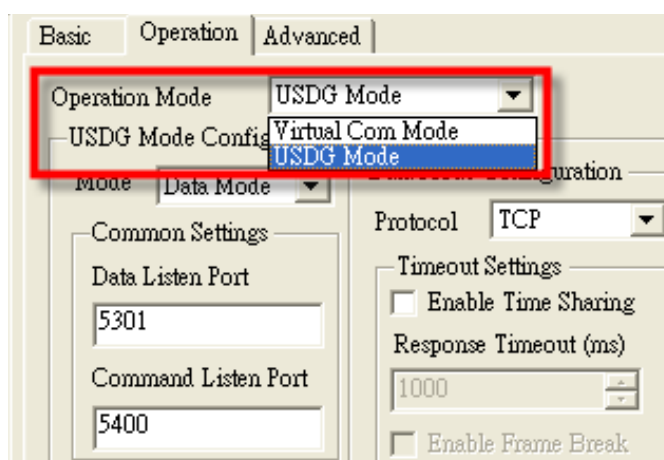

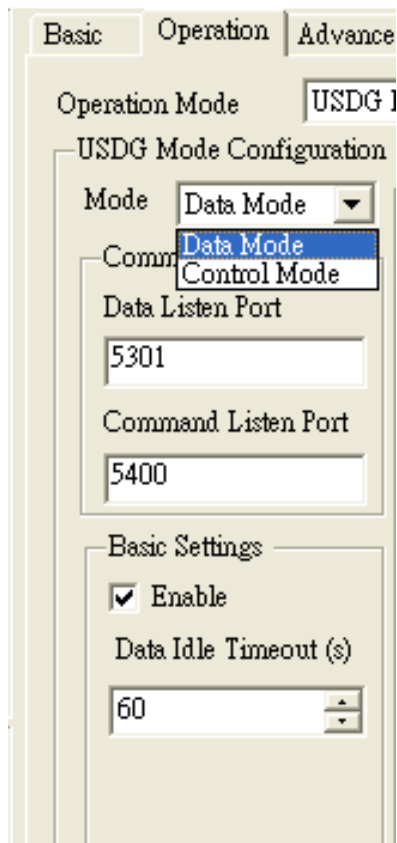

- Mode: There are two kinds of operation modes: Data Mode and Control Mode.
- To use TCP server operating mode correctly, you have to select Data Mode.
- Data Listen Port: The TCP (UDP) port number represents the source port number, and the number is used to identify the channel for remote initiating connections. Range: **1024-65533**. If an unknown caller wants to connect to the system and asks for some services, they need to define the TCP (UDP) port to carry a long-term conversation. Each node on a TCP/IP network has an IP address, and each IP address allows connections on one or more TCP port. The well known TCP ports are those that have been defined; for example, port 23 is used for Telnet connections. There are also custom sockets that users and developers define for their specific needs. Each port has its own data listen port to accept connected request of other network device. So, the data listen port can't be set the same value. You can transmit/receive data to/from device via the data listen port.
- Command Listen Port: Each port has its own command listen port to accept connected requests of other network devices, thus the command listen port can't be set the same value. You can use 'AT command' to change the port setting via the command listen port. The Command Listen Port must be different from the Data Listen port.
- Enable Data Idle Timeout: The default is 60 seconds. You are allowed disabling this function if you want to keep the connection working continuously. The data idle timeout is the interval in which the device waits for data. If the EKI-1351/1352 does not receive data over an established idle time, the connection will be disconnected temporarily, and then will be activated once the device receives data.

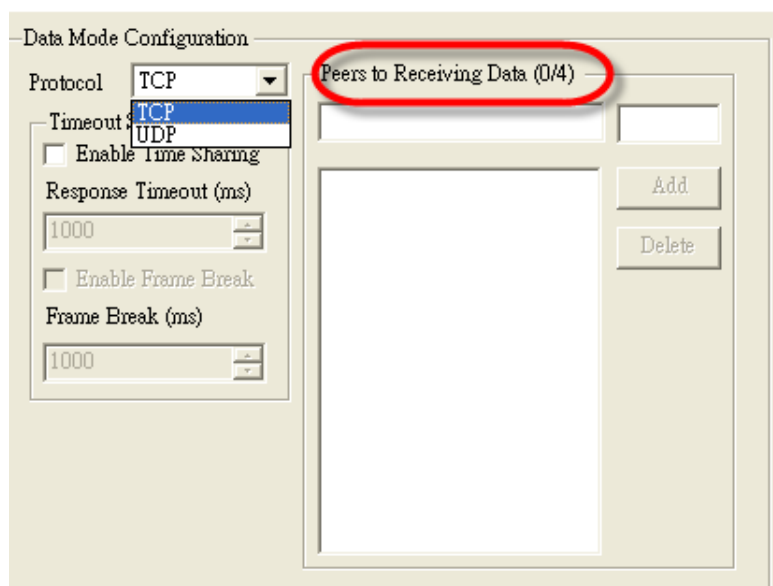

- Protocol: TCP and UDP.
- Enable Time sharing: This function is the same with the Multi-Access function. Please refer to the virtual COM operating mode setting.
- Peers to Receiving Data: You can set maximum 4 network devices which you want to connect. You need to fill out the IP Address and Port of network devices which you want to connect.

3.4.4 Setting Control Operating Mode Parameters

The “Control mode” is a very special operating mode. The EKI-1351/1352 presents a modem interface to the attached serial device: it accepts AT-style modem commands to connect / disconnect to other networking device. If you want serial device running application program to connect/disconnect to different devices dynamically, you can use controlling mode.

The “Control mode” provides three kinds of modem AT-style commands. The serial devices can use these commands to control EKI-1351/1352 to connect/disconnect to remote networking device. Thus, intelligent serial devices such as stand-alone PLC will send /receive data to/from devices one by one via Ethernet.

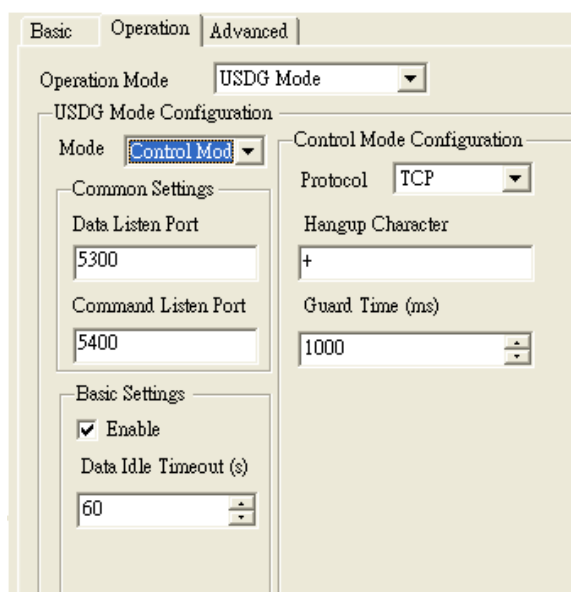

Please refer to the TCP/UDP server operating mode to setup the Data Listen Port, Command Listen Port, and Data Idle Timeout.

- Hangup Character: The default character is "+". After you have connected to another serial device via EKI-1351/1352, you may need to disconnect. Then you can use the command "+++" to disconnect. To do this leaves your keyboard idle (don't press any keys) for at least several seconds, then press "+" three times. You can set "Guard Time" to define the idle time. Be sure that you have to press "+" over the idle time.
 - Guard Time (ms): The default value is 1000.
- For example: <Guard Time> + <Guard Time> + <Guard Time> +

The following commands are available for EKI-1351/1352.

Table 3.1: AT Commands List

Command	Function
ATDT<IP address> <TCP port> <CR>	“Forms a TCP connection to the specified host. Ex: ATDT 192.0.55.22:5201 In above example, the EKI serial device server forms a raw TCP connection to the networking device (192.0.55.22). The TCP port is 5201.”
ATA <CR>	Answering an incoming call
+++<CR>	Returns the user to the command prompt when entered from the serial port during a remote host connection.
<LF><CR> OK <LF><CR>	Commands are executed correctly
<LF><CR> CONNECT <LF><CR>	Connect to other device
<LF><CR> RING ddd.ddd.ddd <LF><CR>	Detect the connection request from other device, which IP address is ddd.ddd.ddd.ddd.
<LF><CR> DISCONNECT <LF><CR>	Disconnect from other device
<LF><CR> ERROR <LF><CR>	Incorrect commands
<LF><CR> FAIL <LF><CR>	If you issu an ATDT command and can not connect to the device, it will response “FAIL”.

3.4.5 Advanced Setting

The EKI-1351/1352 serial device server provides the advanced settings for some special applications which need critical time requirements. In normal applications, these settings are recommended not to be set to avoid the unusual action happened.

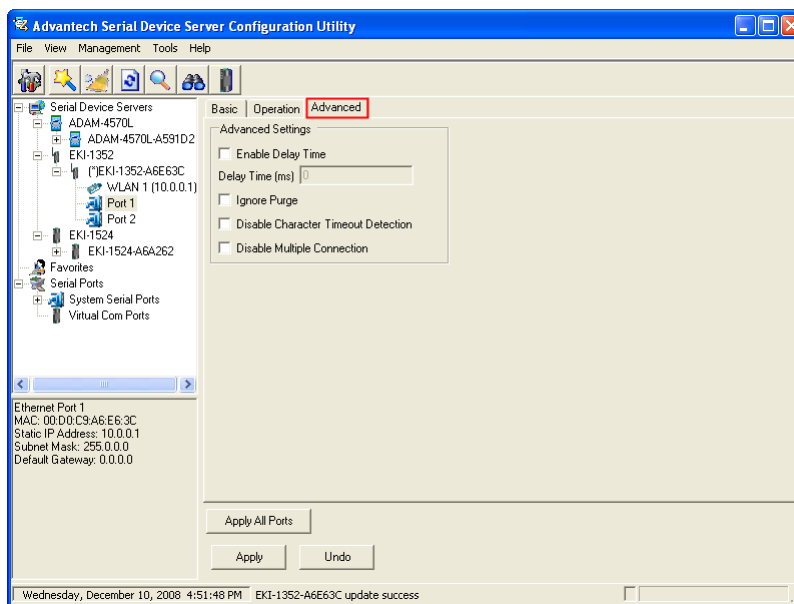

Delay Time (ms)

When you enable the delay time, the serial port will postpone the received data for the time interval you set, and then send the received data to the TCP/IP network.

Ignore Purge

Some application program will purge the serial port while it is the first time opens this serial port. You can ignore the purge command by enable this option.

Disable Character Timeout Detection

Enable this option will disable the serial port character timeout detection.

Disable Multiple Connection

Enable this option will disable the multi-access function, thus the only one TCP connection is allowed on this serial port.

Note! *These settings are just for some special application cases. We recommend do not enable the advanced settings in normal usage.*



3.5 Security Configuration

3.5.1 Accessible Function

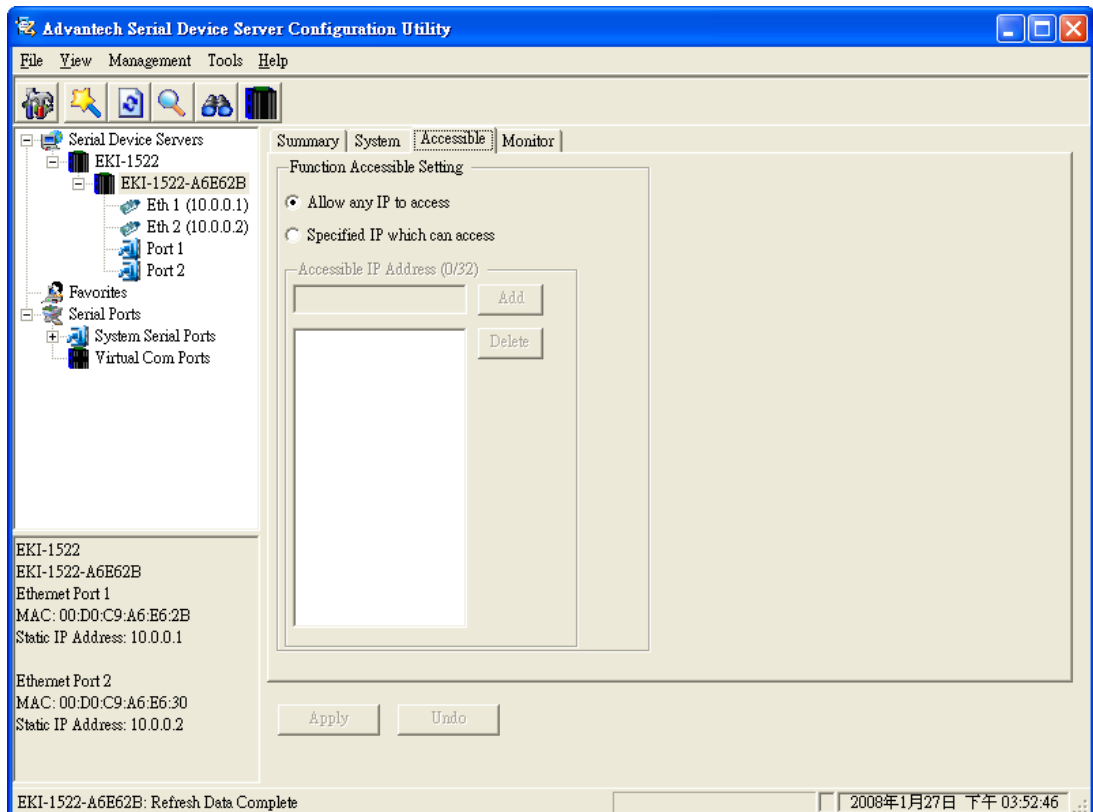

- **Allow any IP to access.**
If this function is enabled, any PC can access data from this serial device server.
- **Specified IP which can access**
If you want to restrict access to certain PCs, you can list their IP addresses in this area. The limit is 32 PCs.

3.5.2 Port Monitor

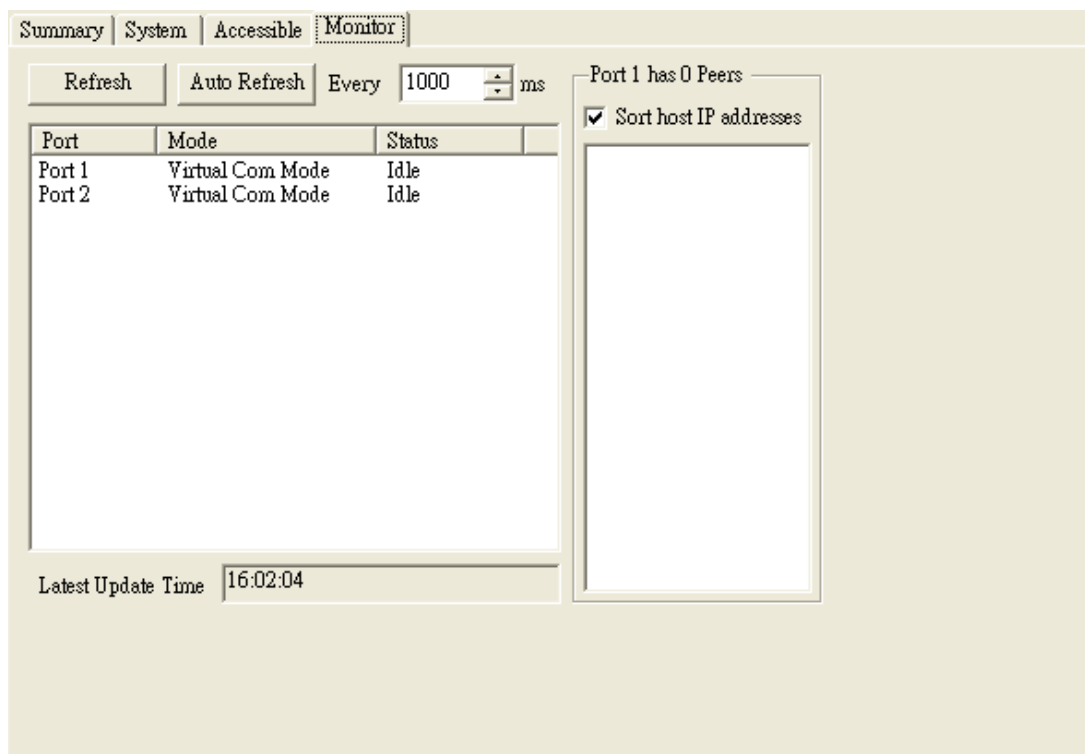

Advantech Serial Device Server Configuration Utility provides an excellent function to monitor the serial port status. Users can check the status of the serial ports.

- Refresh
Update port status manually when you click “Refresh” button.
- Auto Refresh
You can set up the scanning period you want to auto refresh the port status. The default interval is 1000ms. When you click “Auto Refresh” button, it will start updating the port status periodically upon the set interval until you click the “Stop” button.

3.6 Fulfilling Administrator Functions

There have many administrator functions in Advantech Serial Device Server Configuration Utility, right click on device name in the sub-tree of Device Server List Area, you can import and export serial port setting, refresh data, locate the devices...etc.

EKI-1522-A6B62B
Import Serial Port Setting
Export Serial Port Setting
Refresh Data
Locate
Lock Device
Restore to Factory Default Settings
Reset Device
Add to Favorite
Auto Mapping
Manual Mapping
Update Firmware

3.6.1 Import/Export Serial Port Setting

You can save or recover the configuration of serial port via .sps file format.

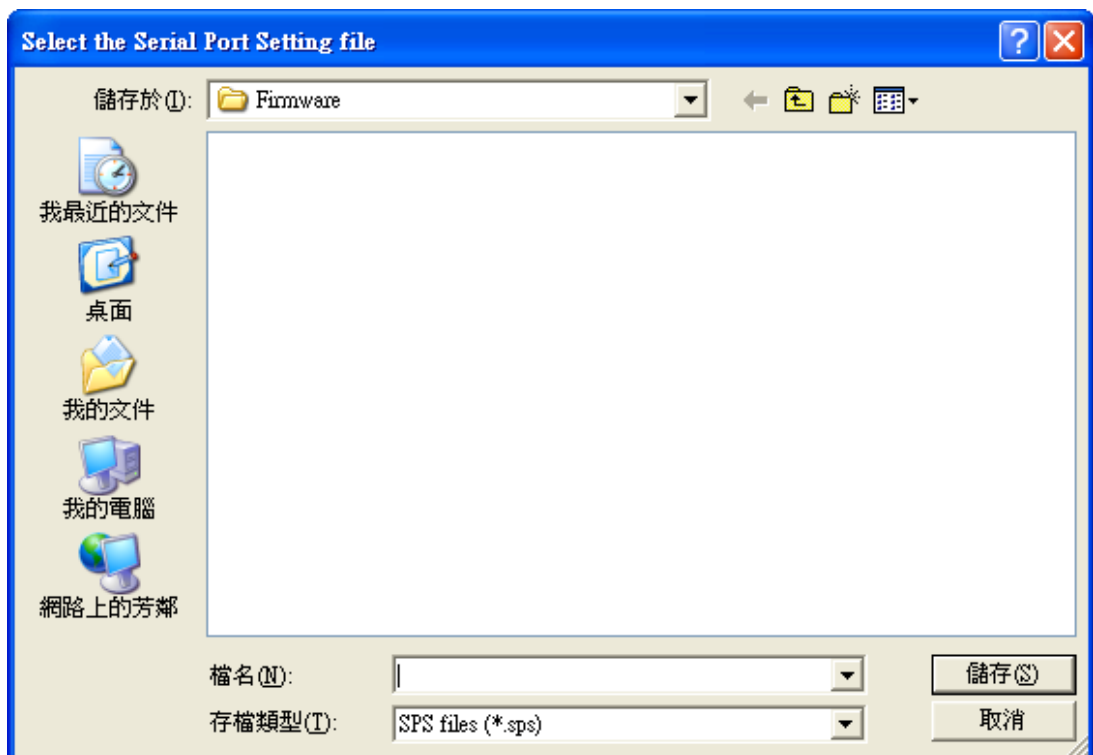

3.6.2 Locate Serial Device

Once you use this function, the device sever you chose to locate, its "Status" LED will be lit until you click "Stop Locate" option.

3.6.3 Lock Device

The configuration utility provides Lock Device function (password protection), when you use this function you need to fill in a set of password. Then, other host computers will no longer be able to configure this device server. Notice that you need to "Reset Device" in order to store password into the device server.



Be Locked

If you want to unlock the device server, right click on the device name and select the "Unlock Device". You need to fill in the password you have set before to unlock the device server. If you forgot the password, the only way to solve this problem is to restore the setting of device server to factory default which will be introduced later.

If you want to disable the password protection, you need to change password to default "None" (leave the new password dialogue box blank and press "OK". Please remember to reset the device server to save the setting.

3.6.4 Restore to Factory Default Settings

The utility provides a method to let you restore the device server to factory default setting. While you select this function, a confirm message will be pop-up. If you really want to restore the device server to factory default setting, please click "Yes" button to continue.



Then, please power off the device server within ten seconds, after reconnecting the power back, the setting will be reset to the factory default. If the power remains more than ten seconds, the device server will not have any change.

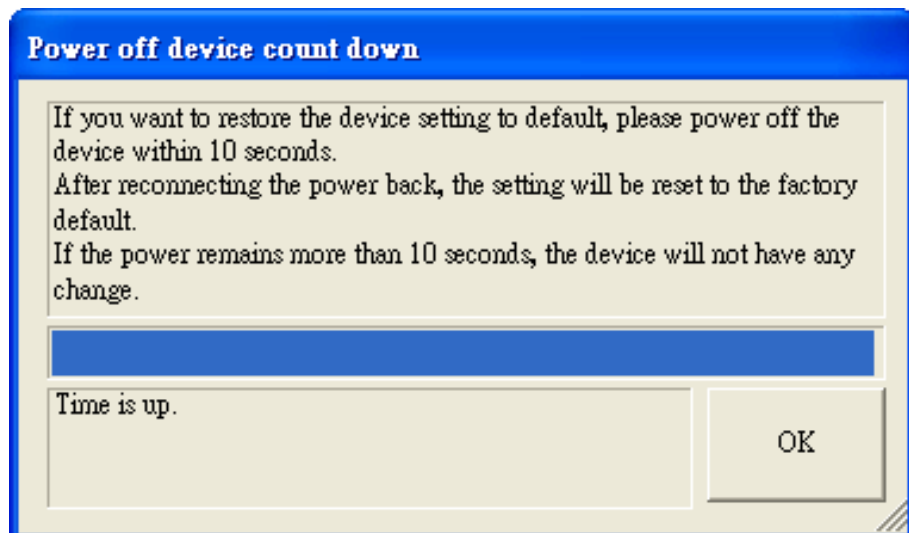

3.6.5 Upgrading the Firmware

Advantech continually upgrades its firmware to keep up with the ever-expanding world of computing. You can use the update firmware function in the utility to carry out the updating procedure. Please access Advantech's Website at <http://www.advantech.com> to download the latest version of the firmware.

1. Right click on the device name and select the "Update Firmware" function.

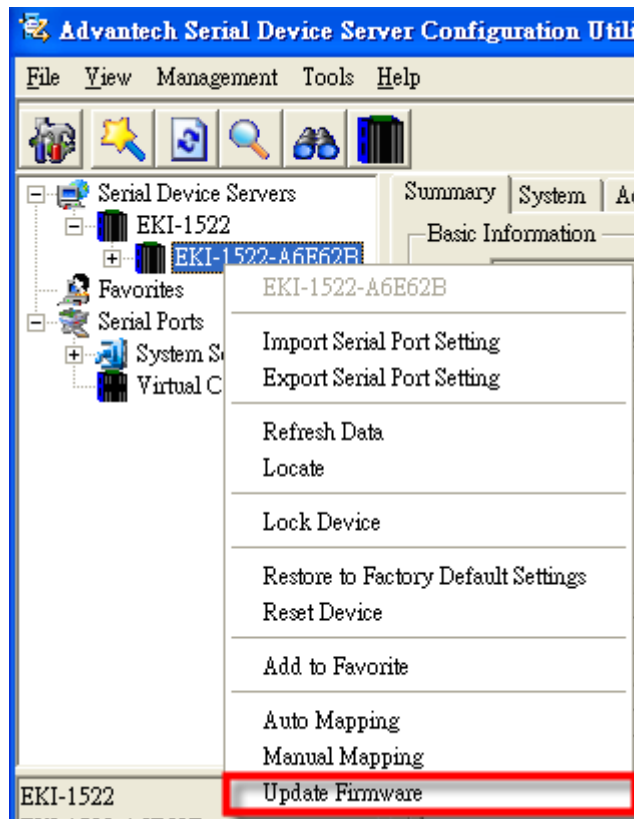

2. Select the firmware you want to update.

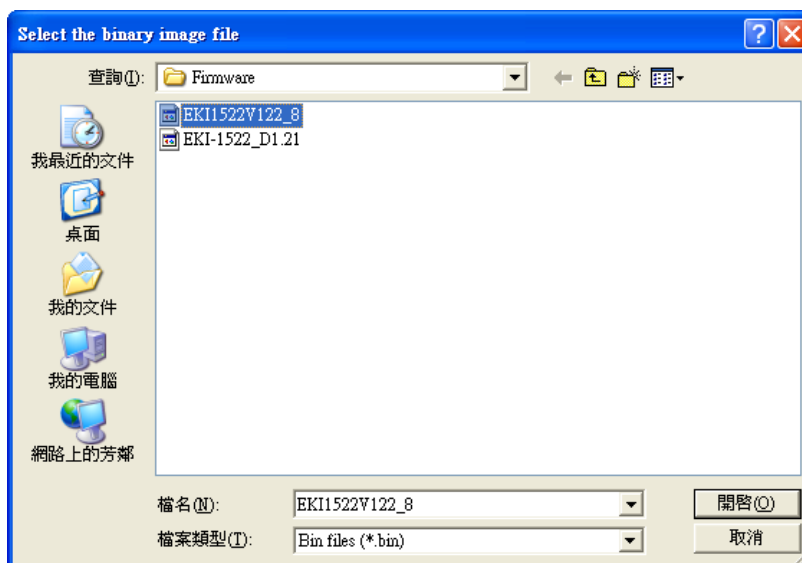

3. After downloading the firmware completely, click on the “OK” button. The serial device server will restart automatically.

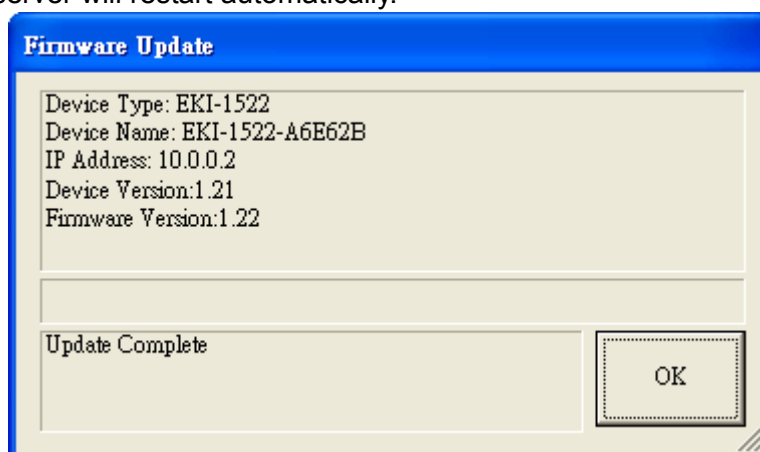

Chapter 4

Setting COM
Redirector

4.1 Setting COM Redirector(Virtual COM port)

Advantech COM port mapping software is a serial COM port redirector that creates virtual COM ports and provides access to serial devices connected to Advantech serial device servers. Your serial device applications can communicate with serial devices connected to Advantech serial device servers without software changes. Since the virtual COM ports work like standard Windows COM ports, your application software sees no difference between a local serial device and one connected to a Advantech serial device server.

COM redirector utility and Virtual COM port Management utility are integrated into one utility with same GUI. Advantech Serial Device Server Configuration Utility can create all Virtual COM ports using “Auto Mapping” function. You can map the Virtual COM port by yourself.

4.1.1 Auto Mapping

Right click the serial device name on the sub-tree of Device Server List area and select the “Auto Mapping” function.

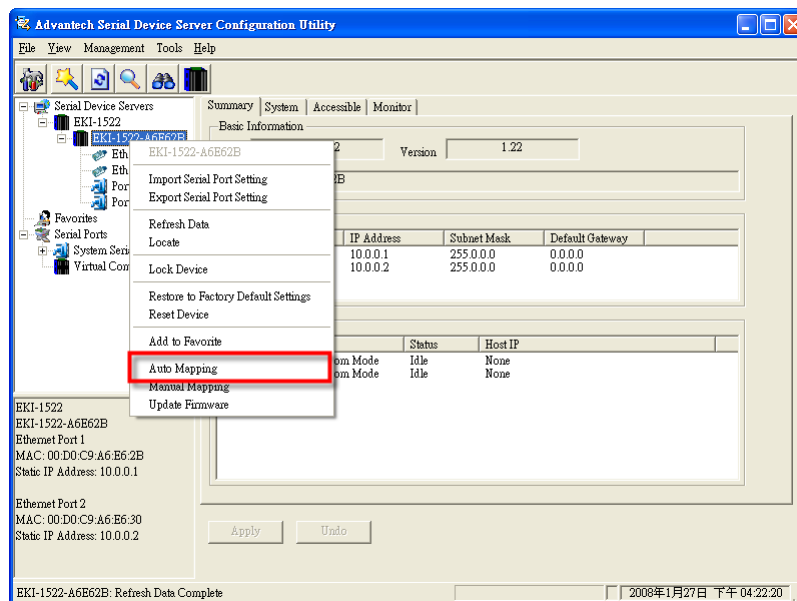

The serial ports that can be assigned to virtual COM will be shown in this window. Select the serial ports you wish to map or click the <Select All> button and press <Map Selected Ports> button. The selected serial ports will be mapped to virtual COM ports in sequential order.

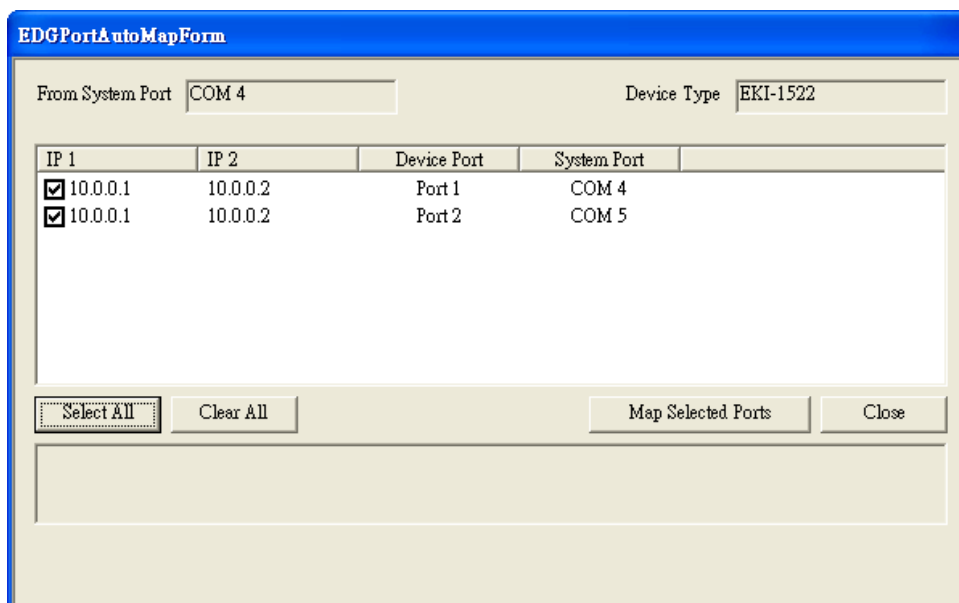

The COM ports in the “Virtual Com Ports” list are now available for use by Windows applications.

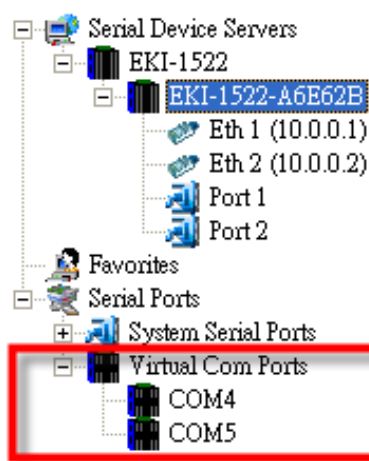

4.1.2 Manual Mapping

Right click the serial device name on the sub-tree of Device Server List area and select the “Manual Mapping” function.

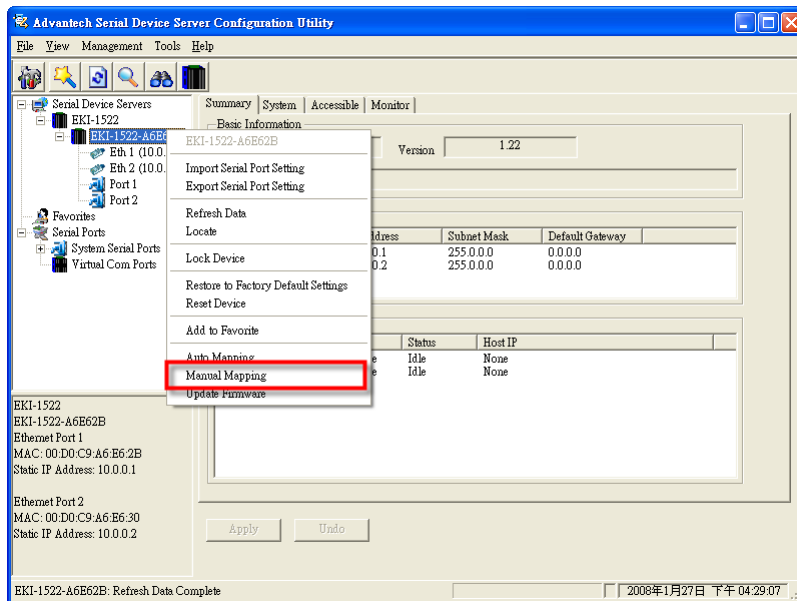

ADAM series, EDG series, and EKI wireless series have only one IP address. You can select the serial port on the device server and the host COM that you want to set. Press <Map it> to establish the virtual COM port on the host.

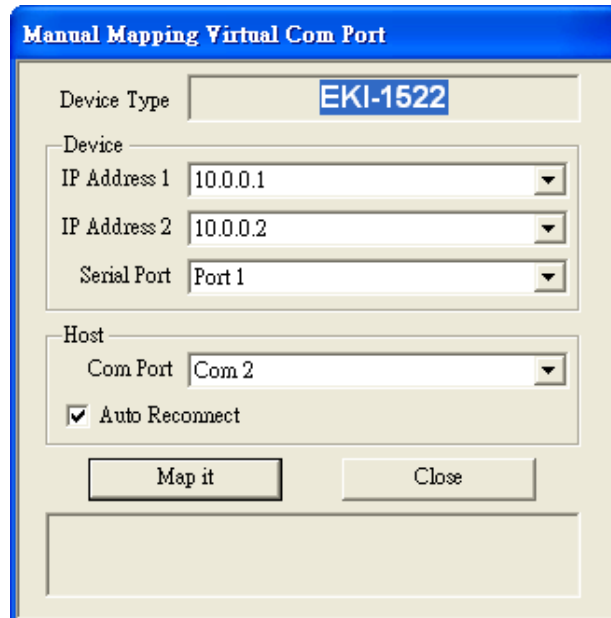

Auto Reconnect Property

Sometimes, the connection between Advantech serial device server and HOST is interrupted by network traffic or powered-off by accident. In such a situation, the host has to reconnect to Advantech serial device server. The function "Auto Reconnect" is for this purpose, if the Advantech serial server loses the connection to its host, the COM redirector will try to re-establish the connection while the host's AP access the virtual COM port. The COM redirector DOES NOT re-establish the connection automatically. When the connection is working again, the host's commands will be automatically received by the Advantech serial device server again. Reconfiguration is not necessary, so this function enhances the reliability of the system.

If the function is disabled, the connection can not be re-established again unless the COM redirector or host is restarted.

EKI-1351/1352 has two Ethernet ports. You can select two Ethernet port to establish two Ethernet connections with one virtual COM port. It means that COM redirector will use one connection with the COM port on device server to communicate. If this connection failed, COM redirector will establish another Ethernet connection to communicate with device. The switch time will be 3 seconds ~ 5 seconds depending on the network traffic and host status.

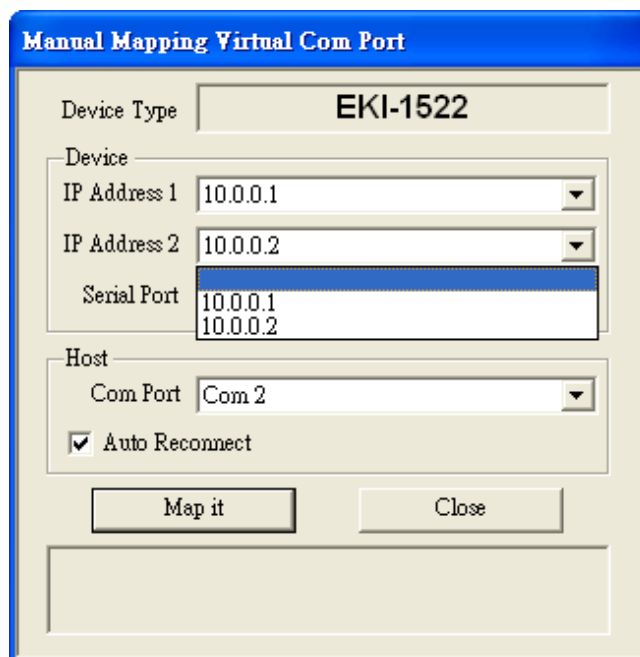

If you don't use the redundant function, you just select the correct IP address in the IP address 1 field.

Note If you set the wrong IP address, COM redirector will still try to connect the device. It might cause the system performance low or other issue.

4.1.3 Manual Direct Mapping Virtual COM Port

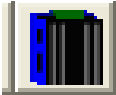
Click the  button on the Quick Took area, you can add a target by selecting the Device Type and inputting the IP address without physically connecting the serial device server to the network.

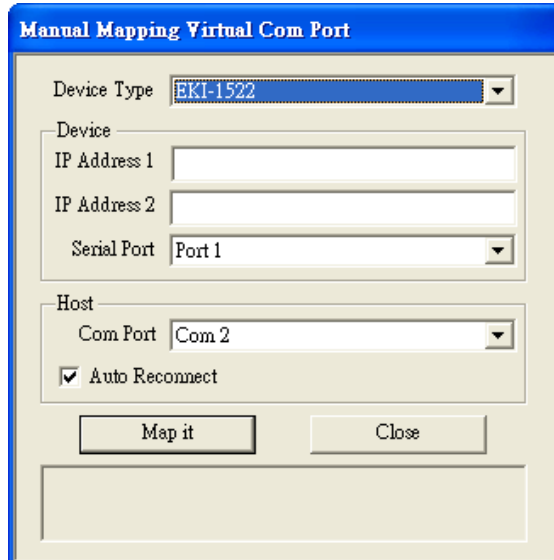

4.1.4 Remove the Virtual COM Port

If you want to remove the virtual COM port, you can remove them one by one or group remove ports.

- Individually Remove
Right click on COM port you have mapped and select "Remove This Port".

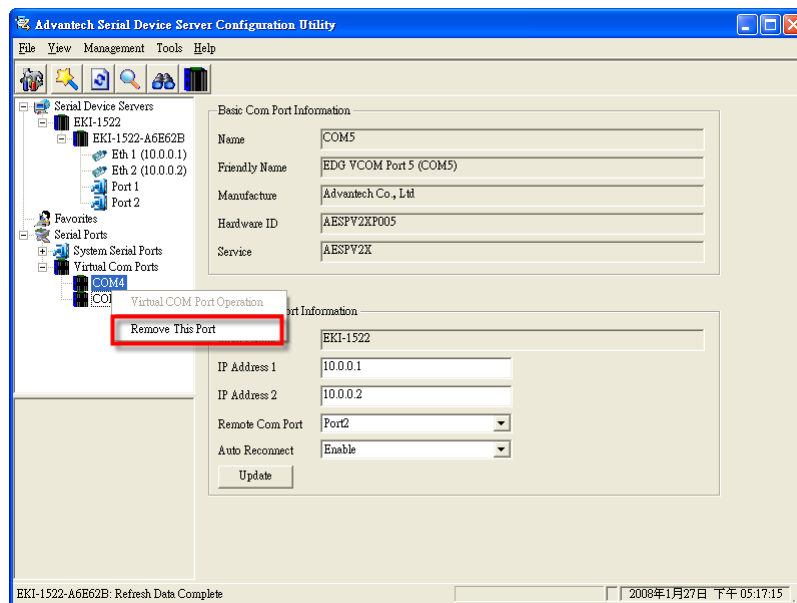

- Group Remove Port
Right click on Virtual Com Ports on Device Server List Area and select "Group Remove Port", you can choose which ports you want to remove.

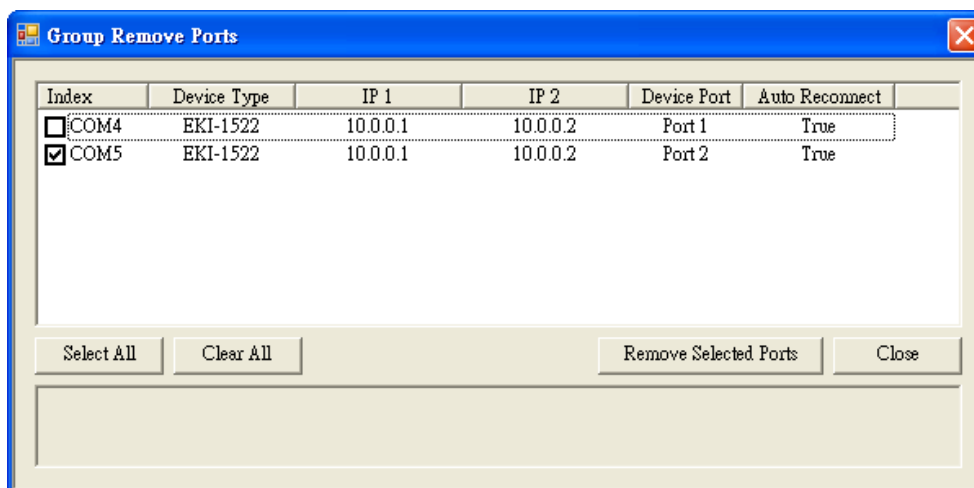

4.2 Running Diagnostic Test

The purpose of this test is to make sure the communication from host PC to EKI-1351/1352 is OK. If there is still an error, you can check the communication from the EKI-1351/1352 to the devices.

If the test is selected, an external test will be done to check that the connection signals for each port are working properly. **For the test, you will need to connect each port to a loopback tester (provided in the package). The loopback test only applies to RS-232 mode.** The test is divided into two parts: Signal test and Communication Parameters test.

Note Before you do this diagnostic test, you must complete the process of virtual COM port mapping.

1. Click "Simple Serial Test" on the Tools menu.

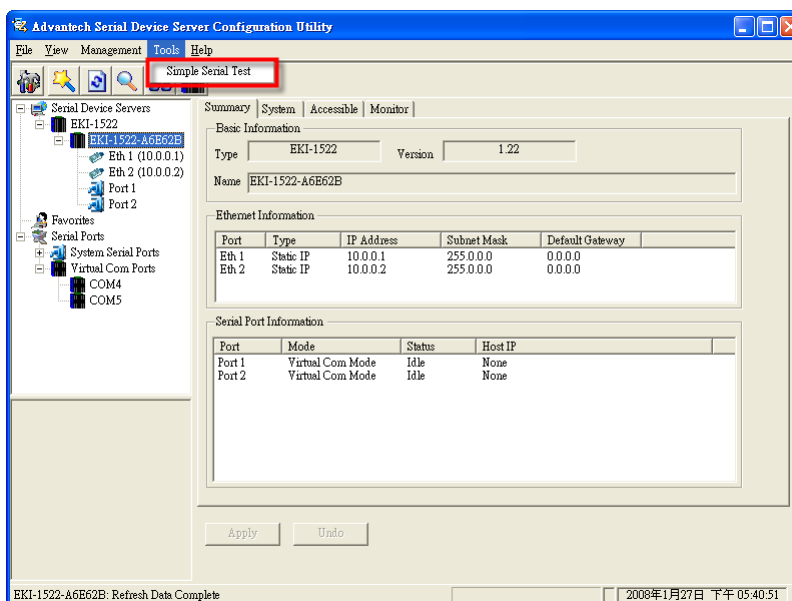

2. Select which COM port you want to run diagnostic test, and then press “Test” button to process the testing.

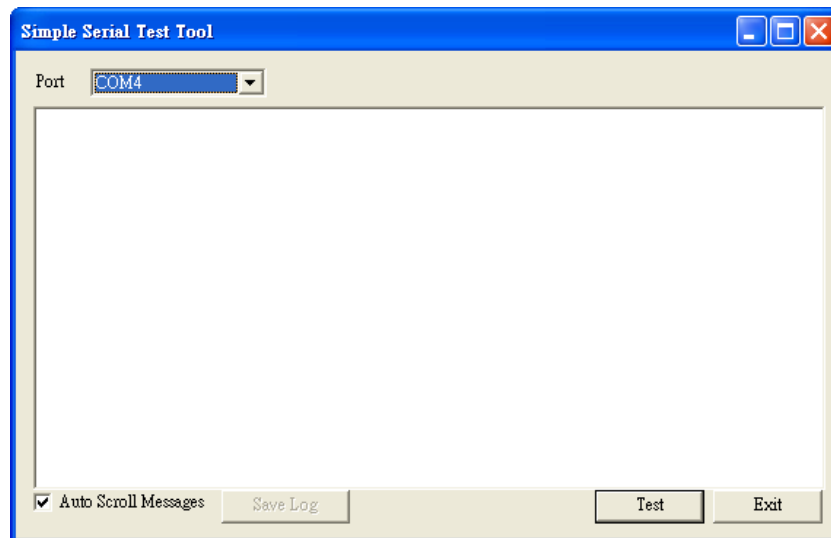

Signal Test

- RTS -> CTS check the RTS and CTS signal between two ports
- DTR -> RI check the DTR and RI signal between two ports
- DTR -> DSR check the DTR and DSR signal between two ports
- DTR -> DCD check the DTR and DCD signal between two ports

Communication Parameters Test

- Baud rate 50bps ~ 921.6kbps
- Data bit 5, 6, 7, 8
- Stop bit 1, 1.5, 2
- Parity Odd, Even, None, Space, Mark

When the test is finish, it will show the test result, the click “Exit” button to return to the utility window.

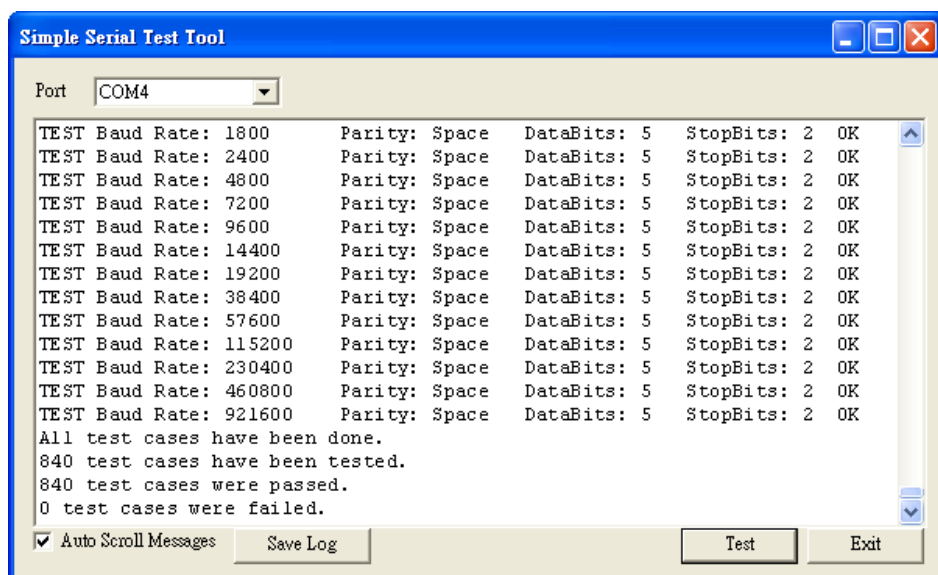

Chapter 5

Web-Based
Configuration

5.1 Overview

EKI-1351/1352 serial device server can be configured through a web interface. By using a standard web browser, the same procedure as with the Windows configuration utility can be used. In the browser's address field, enter the IP Address of your EKI-1351/1352 serial device server. The default IP setting is 10.0.0.1, but you should use the IP which you have previously assigned for this device. Once the IP is entered, you will be presented with the following windows.

Note! Before using the web-based configuration, make sure your host PC Ethernet network IP domain is as same as the serial device server, or it can establish the TCP connection with the serial device server.



5.2 Accessing the Web Page

By configuration utility

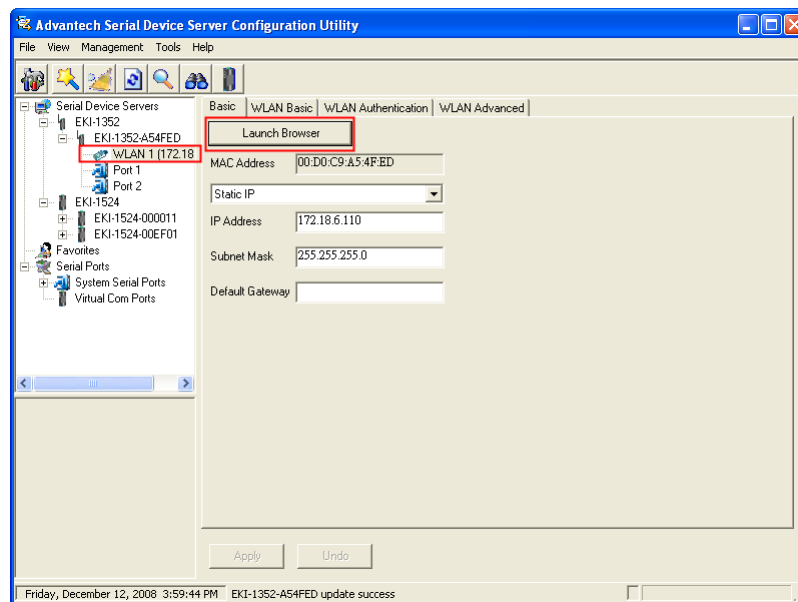

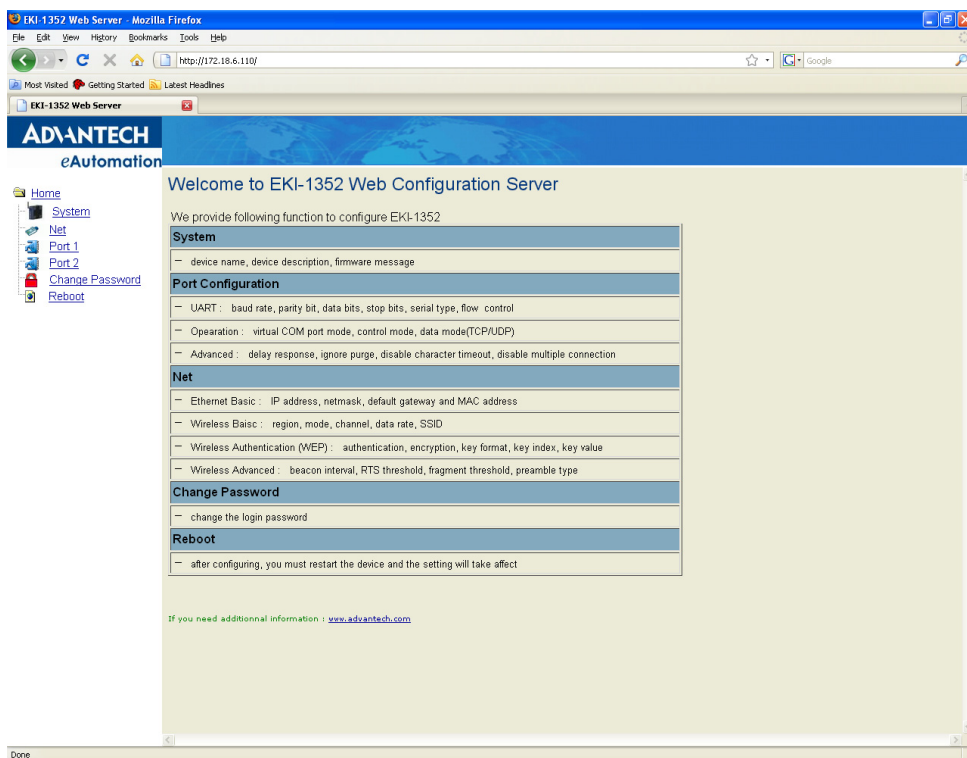

By Internet Browser

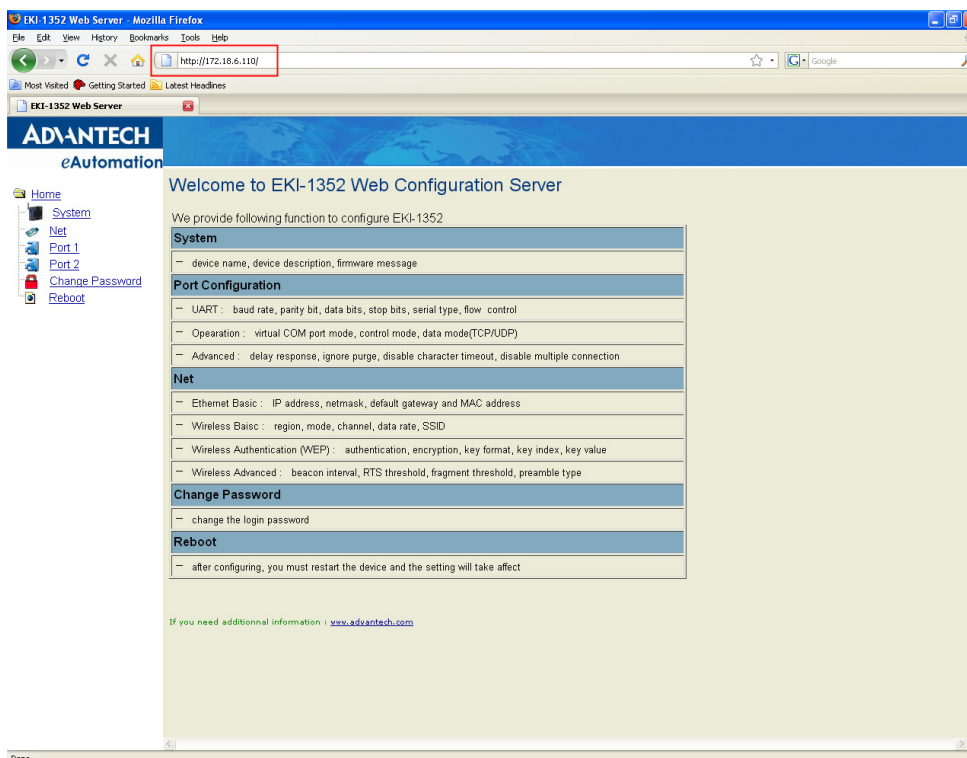

5.3 System

You can change the Device Name and Device Description on this page.

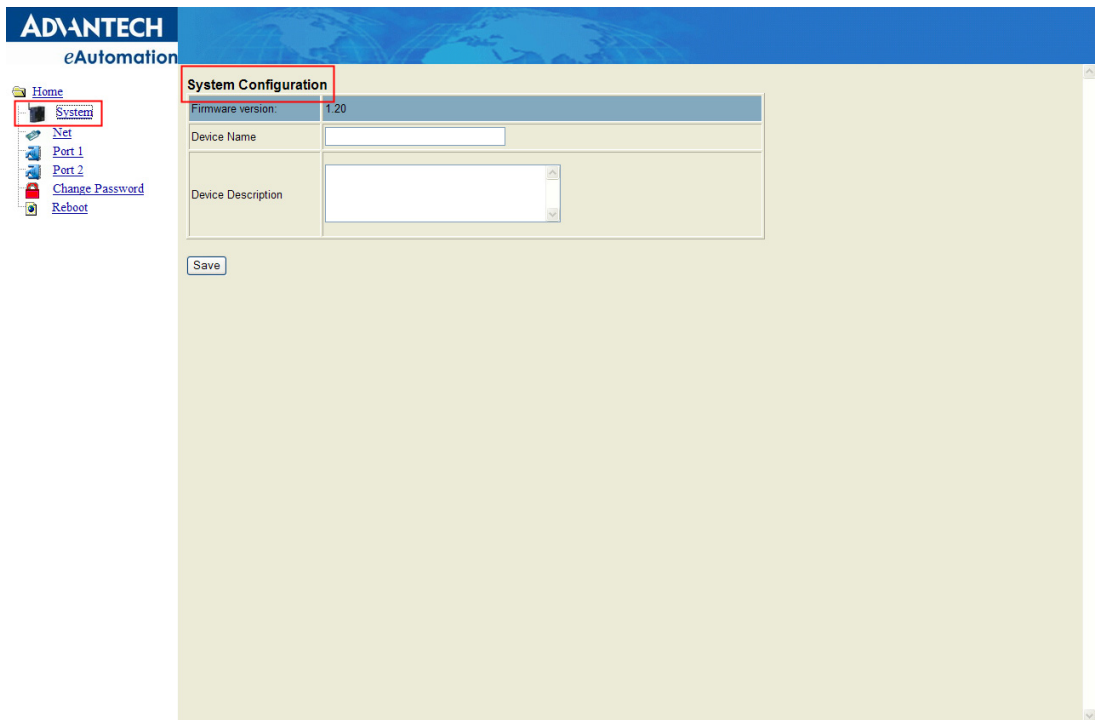

5.4 Network Configuration

Click the Net Configuration, there are Net Mode, IP Address, Subnet Mask, and Default Gateway. Enter the corresponding values for your network environment. Remember press "Save" after fill in all values.

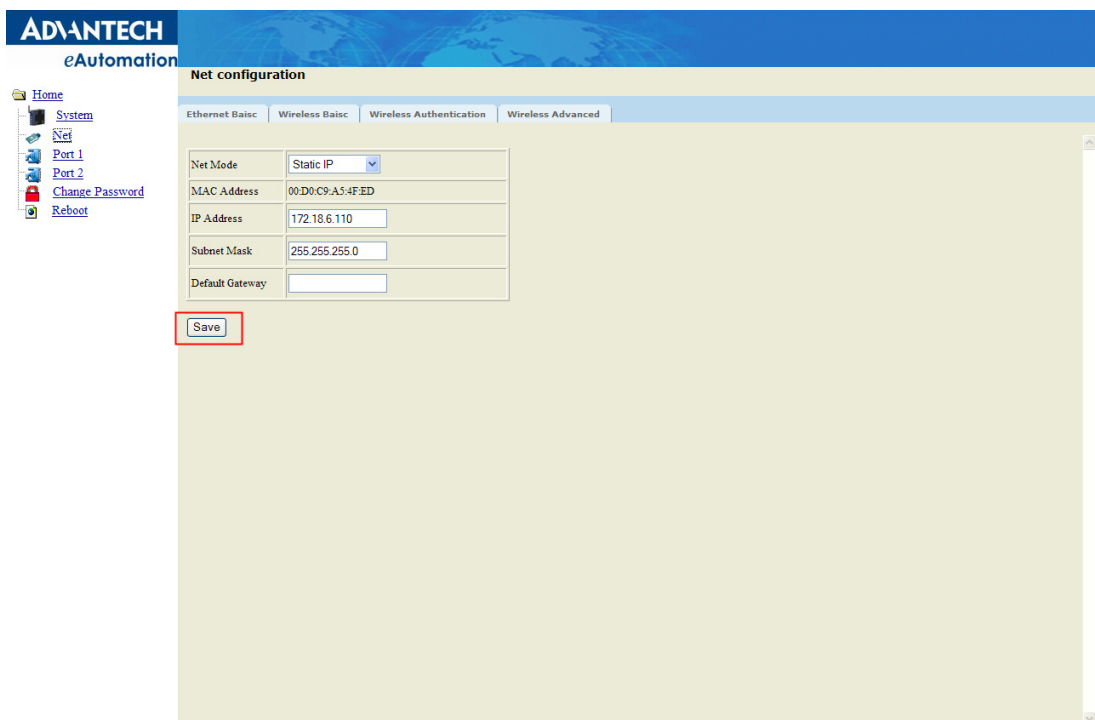

Note! All new configurations will take effect after rebooting. The reboot function is located on the main menu of the Web Configuration.



5.5 Port Configuration

There are Basic, Operation Mode, and Advanced Setting in the serial port configuration. For more detailed information for setting, please refer to chapter 3.4 and chapter 3.5.

The screenshot displays the 'Port 1 configuration' page in the ADVANTECH eAutomation web interface. The sidebar menu on the left includes 'Home', 'System', 'Net', 'Port 1', 'Port 2', 'Change Password', and 'Reboot'. The 'Port 1' menu item is highlighted with a red box. The main configuration area is titled 'Port 1 configuration' and has three tabs: 'Basic', 'Operation', and 'Advanced'. The 'Basic' tab is selected, showing the following settings:

Type	RS232
Baud Rate	9600
Parity	None
Data Bits	8
Stop Bits	1
Flow Control	None

A 'Save' button is located at the bottom of the configuration area.

5.6 Change Password

You can change the serial device server password on here:

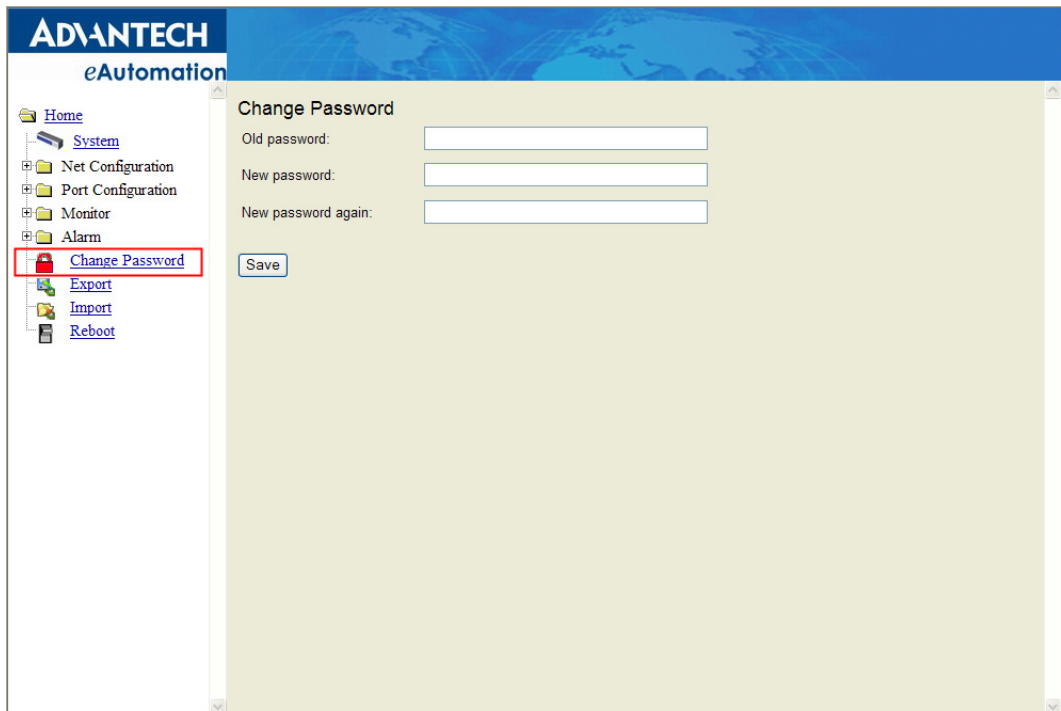

If you have set a password via the configuration utility or Telnet or serial console, when you access the web configuration, you need to key in the password. Do not need to enter the username in the dialog.



If you want to disable the password protection, just change the password to the default "None" (leave the new password column blank), Be sure to press the "Save" button and reboot the serial device server to make the change effective.

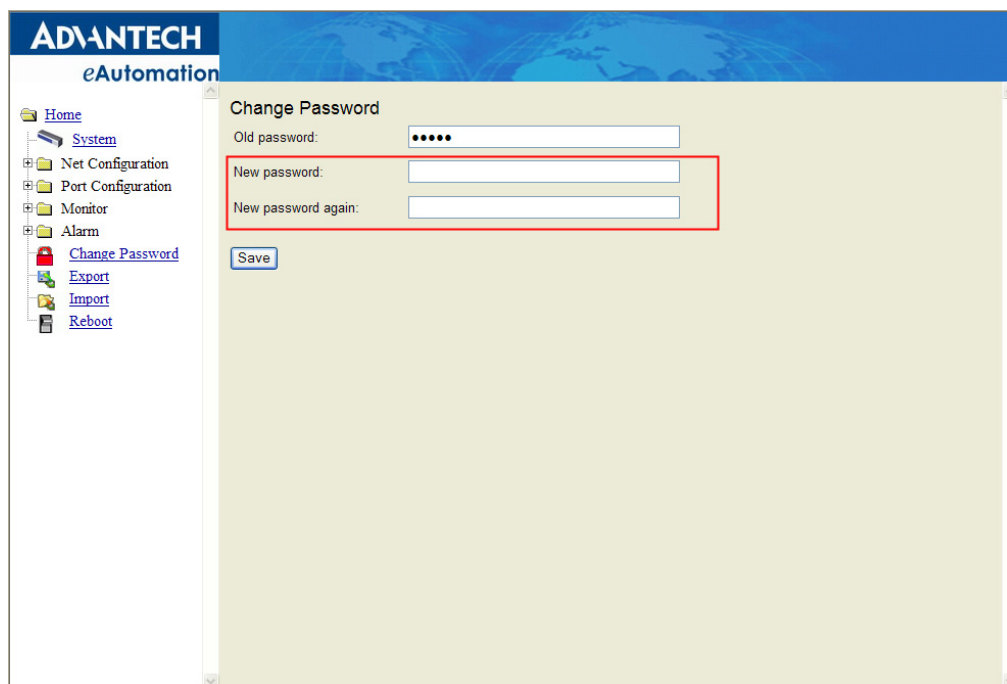

5.7 Reboot

The configuration will take effect after clicking “Save” button. But all configurations will save to flash memory after this reboot step. Press the “Reboot” button and the system will give a reset response. It will take a few seconds to reconnect with the new values.



Appendix **A**

Quick Start

There are two ways to complete the wireless connection between an access point and EKI-1351/1352; via Diagnostic Ad hoc Mode or Diagnostic Infrastructure Mode. We recommend you use Ad hoc if your host PC is equipped with a wireless module.

A.1 Diagnostic Ad hoc Mode

(With wireless module)

1. Set the switch of EKI-1351/1352 to **Diagnostic Mode**, then power on.
2. Wait for 10 to 20 seconds until the signal quality is stable.
3. Start the wireless module on your host PC (Only the WLAN is active now, ensure the Ethernet link is inactive), scan the existing wireless BSS (Basic Service Set) on your site.
4. Find the SSID named **WLAN**.
5. Connect to WLAN BSS, and check the configuration information to make sure the connection is OK.

Note: Our EKI serial device servers have SSID: WLAN and Channel: 10 as default.

6. Start the Serial Device Server Configuration Utility tool on your host PC, and find the EKI-1351/1352. You can see the default setting as below.

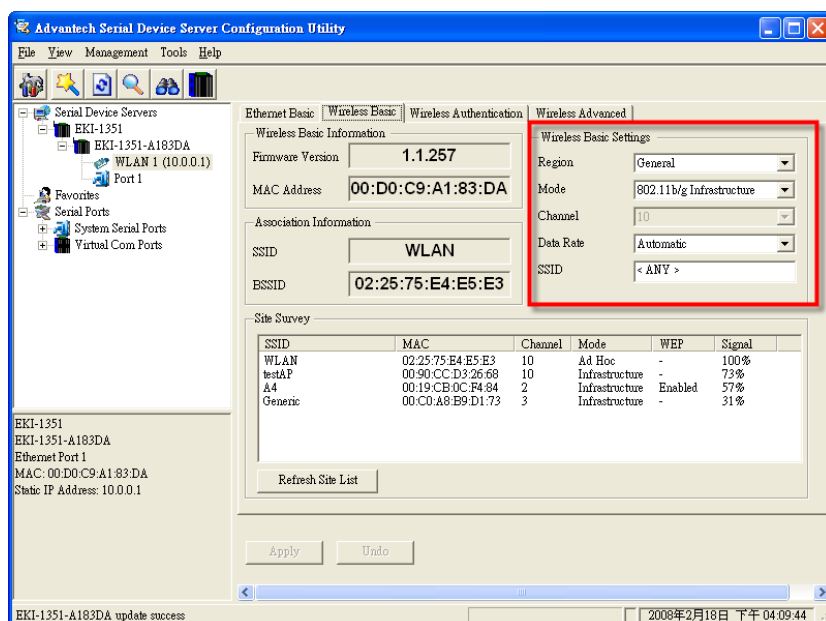
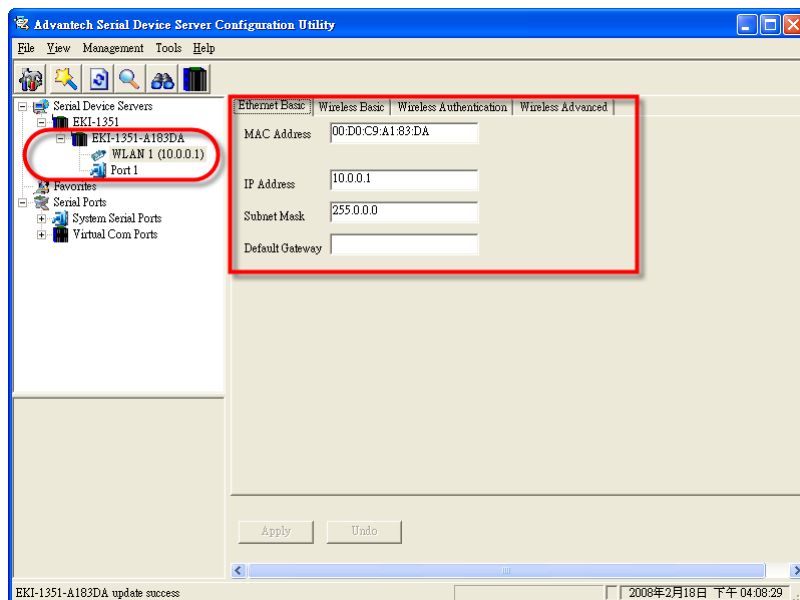

- Reset the Ethernet Basic settings and Wireless Basic settings as needed. (About these settings, please refer to section 3.3.1 and 3.3.2 of the manual)

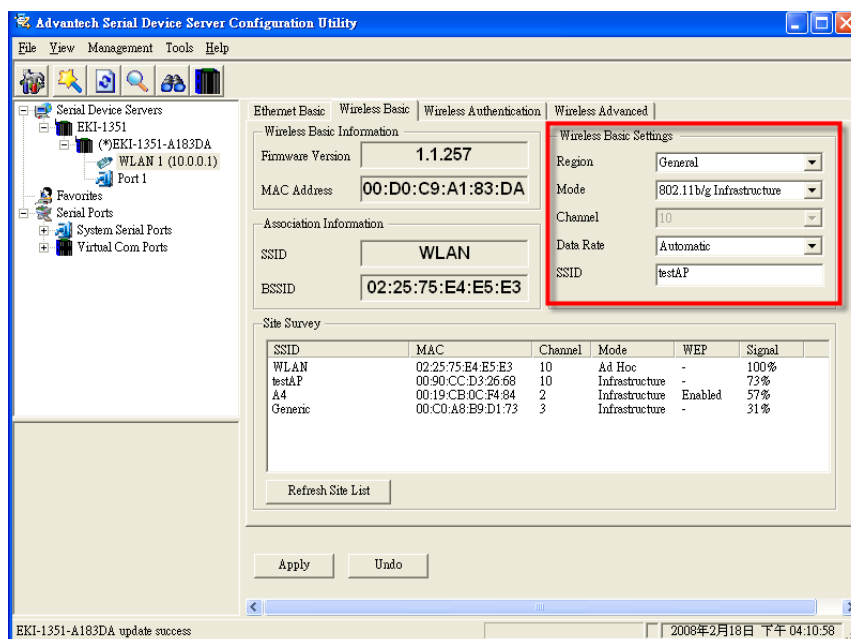

- Power off EKI-1351/1352, adjust the switch to **Normal Mode**, and then reboot it to finish the wireless connection. Now you can configure and set up port mapping through the access point.

A.2 Diagnostic Infrastructure Mode

(Without wireless module)

- Set the switch of EKI-1351/1352 to **Normal Mode**, then power on.
- Wait for 10 to 20 seconds until the signal quality is stable.
- Adjust the switch to **Diagnostic Mode**, and then wait for 5 seconds until the signal strength LED is blinking.
- Return the switch to **Normal Mode**, then EKI-1351/1352 will reboot automatically with Diagnostic Infrastructure Mode. Now EKI-1351/1352 will automatically search the field site for access points and create a connection to the one with best signal strength.
- Start the Serial Device Server Configuration Utility tool on your host PC (ensure your host PC and the possible access points that EKI-1351/1352 can connect to, are in the same network). Find the EKI-1351/1352 on the network.
- Reset the Ethernet settings as required. (About these settings, please refer to section 3.3.1 of the manual)
- Power off EKI-1351/1352, confirm the switch on **Normal Mode**, and then reboot it to finish the wireless connection. Now you can configure and set up port mapping through an access point.

ADVANTECH

eAutomation

www.advantech.com

Please verify specifications before quoting. This guide is intended for reference purposes only.

All product specifications are subject to change without notice.

No part of this publication may be reproduced in any form or by any means, electronic, photocopying, recording or otherwise, without prior written permission of the publisher.

All brand and product names are trademarks or registered trademarks of their respective companies.

© Advantech Co., Ltd. 2008