

DVP-SE

Instruction Sheet

2012-03-05



5012614900-00SD

Programmable Logic Controller

Thank you for choosing Delta DVP-SE. DVP-SE is a 12-point (8DI + 4DO) PLC MPU, offering various instructions and with 16k steps program memory, able to connect to all DVP Slim type series extension modules and high-speed extension modules, including digital I/O (max. 480 I/O points) and analog modules (for A/D, D/A conversion and temperature measurement). 2 points of 100 kHz and 2 points of 10 kHz high-speed pulse output satisfy all kinds of applications. DVP-SE is small in size and easy to install.

- ✎ This instruction sheet only provides introductory information on electrical specifications, general specifications, installation and wiring. For detailed information on programming and instructions, please refer to “DVP-SE Operation Manual: Programming”. For information about optional peripherals, please see individual product instruction sheet enclosed with DVP-SE.
- ✎ This is an OPEN TYPE device and therefore should be installed in an enclosure free of airborne dust, humidity, electric shock and vibration. The enclosure should prevent non-maintenance staff from operating the device (e.g. key or specific tools are required to open the enclosure) in case danger and damage on the device may occur.
- ✎ DO NOT connect input AC power supply to any of the I/O terminals; otherwise serious damage may occur. Check all the wiring again before switching on the power. Make sure the ground terminal Ⓧ is correctly grounded in order to prevent electromagnetic interference. DO NOT touch any terminals when the power is switched on.
- ✎ COM1 on this model is the Mini USB communication port. It only can be used to upload the program from the PLC, download the program to the PLC, and debug the program temporarily. It is not suitable for the long term monitoring function.

■ Product Profiles

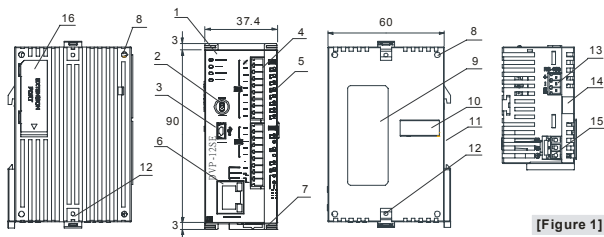

[Figure 1]

Unit: mm

1. POWER, RUN, ERROR, COM1 indicator	9. Nameplate
2. RUN/STOP switch	10. Right-side extension port
3. COM1 port (Mini USB)	11. DIN rail mounting slot (35mm)
4. I/O terminals and COM3 comm. port (RS-485)	12. Extension unit clip
5. I/O point and COM2, COM3 indicator	13. COM2 communication port (RS-485)
6. Ethernet communication port	14. Mounting rail for extension module
7. DIN rail clip	15. DC power input
8. Mounting hole for extension module	16. Left-side module connection port

■ Electrical Specifications

Model	DVP12SE11R	DVP12SE11T
Item		
Power supply voltage	24 VDC (-15 to 20%) (with counter-connection protection on the polarity of DC input power) DVPPS01/PS02: input 100 to 240 VAC, output 24 VDC/1A (PS02: 2A)	
Connector	European standard removable terminal block (Pin pitch: 3.5mm)	

Item	Model	DVP12SE11R	DVP12SE11T
Operation		Maximum power loss time is 10ms or less.	
Inrush current		Max. 7.5 A@24 VDC, $I^2t = 0.25 A^2S$	
Fuse capacity		2.5 A/30 VDC, Polyswitch	
Power consumption		1.8 W	1.5 W
Power protection		With counter-connection protection on the polarity of DC input power	
Insulation resistance		> 5 MΩ (all I/O point-to-ground: 500 VDC)	
Noise immunity		ESD: 8 kV Air Discharge EFT: Power Line: 2 kV, Digital I/O: 1 kV, Analog & Comm. I/O: 1 kV RS: 26 MHz to 1 GHz, 10 V/m	
Grounding		The diameter of grounding wire cannot be smaller than the wire diameter of terminals L and N (All DVP units should be grounded directly to the ground pole).	
Operation / storage		Operation: 0 to 55°C (temp.), 50 to 95% (humidity), Pollution degree 2 Storage: -25 to 70°C (temp.), 5 to 95% (humidity)	
Vibration / shock resistance		International standards: IEC61131-2, IEC 68-2-6 (TEST Fc)/IEC61131-2 & IEC 68-2-27 (TEST Ea)	
Weight (g)		145	135

Spec.		Input Points	
Items		24 VDC (-15 to 20%) single common port input	
Input No.		X0 to X2	X3 to X7
Input type		DC (SINK or SOURCE)	
Input current ($\pm 10\%$)		24 VDC, 5 mA	
Input impedance		4.7 kΩ	
Max. frequency		100 kHz	10 kHz
Action level	Off → On	> 15 VDC	
	On → Off	< 5 VDC	
Response time	Off → On	< 2.5 μs	< 20 μs
	On → Off	< 5 μs	< 50 μs
Filter time		Adjustable within 0 ~ 20ms by D1020 (Default: 10ms)	

Spec.		Output Points		
Items		Relay	Transistor	
Output No.		Y0 to Y3	Y0, Y2	Y1, Y3
Max. frequency		1 Hz	100 kHz	10 kHz
Working voltage		250 VAC, < 30 VDC	5 to 30 VDC #1	
Max. load	Resistive	1.5 A/1 point (5 A/COM)	0.5 A/1 point (2 A/COM)	
	Inductive	#2	15 W (30 VDC)	
	Lamp	20 WDC/100 WAC	2.5 W (30 VDC)	
Response time	Off → On	Approx. 10 ms	2 μs #3	20 μs #3
	On → Off		3 μs #3	30 μs #3

#1: UP, ZP must work with external auxiliary power supply 24 VDC (-15 to +20%), rated consumption approx. 1mA/point.

#2: Life curves

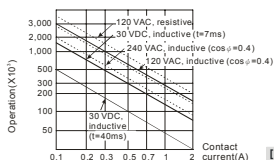

[Figure 2]

#3: Load = 0.5A

■ I/O Configuration

Model	Input		Output		I/O Configuration	
	Point	Type	Point	Type	Relay	Transistor
DVP12SE11R	8	DC (Sink Or Source)	4	Relay	S/S	S/S
DVP12SE11T					X0 X1 X2 X3 X4 X5 X6 X7 C0 Y0 Y1 Y2 Y3 ● SG COM3+ COM3-	X0 X1 X2 X3 X4 X5 X6 X7 Y0 Y1 Y2 Y3 UP ZP SG COM3+ COM3-

■ Dimension & Installation

Please install the PLC in an enclosure with sufficient space around it to allow heat dissipation, See [Figure 3].

- **Direct Mounting:** Use M4 screw according to the dimension of the product.
- **DIN Rail Mounting:** When mounting the PLC to 35mm DIN rail, be sure to use the retaining clip to stop any side-to-side movement of the PLC and reduce the chance of wires being loose. The retaining clip is at the bottom of the PLC. To secure the PLC to DIN rail, pull down the clip, place it onto the rail and gently push it up. To remove the PLC, pull the retaining clip down with a flat screwdriver and gently remove the PLC from DIN rail.

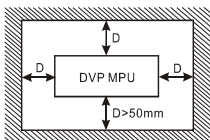

[Figure 3]

■ Wiring

1. Use 22-16AWG (1.5mm) single or multiple core wire on I/O wiring terminals. See the figure in the right hand side for its specification. PLC terminal screws should be tightened to 1.90 kg-cm (1.65 in-lbs) and please use only 60/75°C copper conductor.

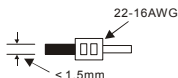

2. DO NOT wire empty terminal. DO NOT place the I/O signal cable in the same wiring circuit.
3. DO NOT drop tiny metallic conductor into the PLC while screwing and wiring. Tear off the sticker on the heat dissipation hole for preventing alien substances from dropping in to ensure normal heat dissipation of the PLC.

◆ Power Supply

The power input of DVP-SE is DC. When operating DVP-SE please note the following points:

1. The power is connected to two terminals, 24 VDC and 0 V, and the range of power is 20.4 to 28.8 VDC. If the power voltage is less than 17.5 VDC, the PLC will stop running, all outputs will go "Off", and the ERROR indicator will start to blink continuously.
2. The power shutdown for less than 10ms will not affect the operation of the PLC. However, the shutdown time that is too long or the drop of power voltage will stop the operation of the PLC, and all outputs will go off. When the power returns to normal status, the PLC will automatically resume the operation. (Please take care of the latched auxiliary relays and registers inside the PLC when doing the programming).

◆ Safety Wiring

Since DVP-SE is only compatible with DC power supply, Delta's power supply modules (DVPPS01/DVPPS02) are the suitable power supplies for DVP-SE. We suggest you install the protection circuit at the power supply terminal to protect DVPPS01 or DVPPS02. See the figure below.

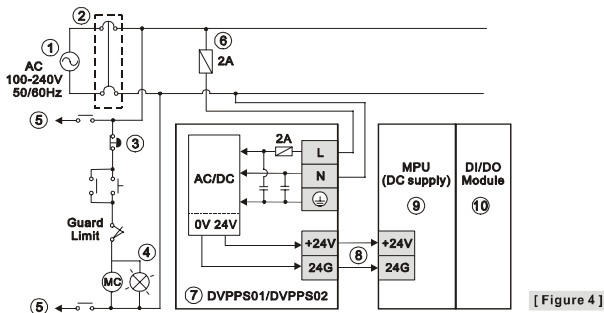

[Figure 4]

- | | |
|---|----------------------------------|
| ① AC power supply:100 ~ 240VAC, 50/60Hz | ② Breaker |
| ③ Emergency stop: This button cuts off the system power supply when accidental emergency takes place. | |
| ④ Power indicator | ⑤ AC power supply load |
| ⑥ Power supply circuit protection fuse (2A) | ⑦ DVPPS01/DVPPS02 |
| ⑧ DC power supply output: 24 VDC, 500 mA | ⑨ DVP-PLC (main processing unit) |
| ⑩ Digital I/O module | |

◆ Input Point Wiring

There are 2 types of DC inputs, SINK and SOURCE. (See the example below. For detailed point configuration, please refer to the specification of each model.)

● DC Signal IN – SINK mode

Input point loop equivalent circuit

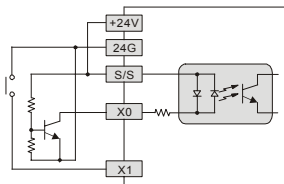

[Figure 5]

● DC Signal IN – SOURCE mode

Input point loop equivalent circuit

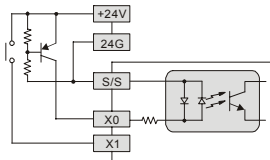

[Figure 6]

◆ Output Point Wiring

- DVP-SE has two output modules on it, relay and transistor. Be aware of the connection of shared terminals when wiring output terminals.
- Relay output terminals, Y0 to Y3 of relay models use C0 common port. See [Figure 7]. When the output points are enabled, their corresponding indicators on the front panel will be on.
- Transistor output terminals, Y0 to Y3 of transistor models use UP, ZP common port. See [Figure 8].

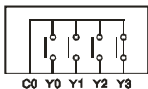

[Figure 7]

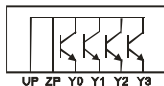

[Figure 8]

4. Isolation circuit: The optical coupler is used to isolate signals between the circuit inside PLC and input modules.

• Relay (R) output circuit wiring

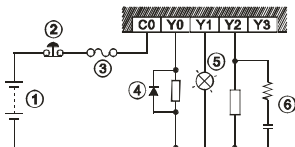

[Figure 9]

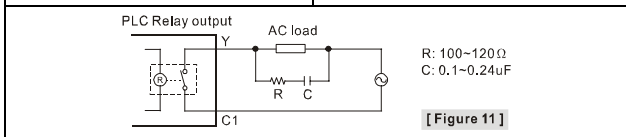
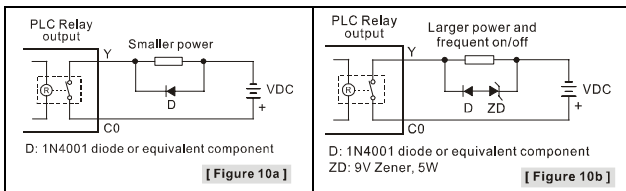

- ① DC power supply
- ② Emergency stop: Uses external switch
- ③ Fuse: 5 to 10A fuse at the shared terminal of output contacts to protect the output circuit
- ④ Transient voltage suppressor (SB360 3A 60V): Extends the life span of contact.
 - 1. Diode suppression of DC load: Used when in smaller power [Figure 10a]
 - 2. Diode + Zener suppression of DC load: Used when in larger power and frequent On/Off [Figure 10b]
- ⑤ Incandescent light (resistive load)
- ⑥ Absorber: Reduces the interference on AC load [Figure 11]

• Transistor (T) output circuit wiring

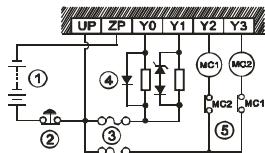

[Figure 12]

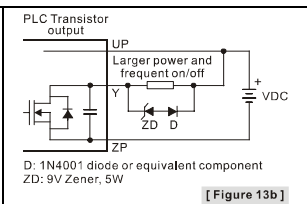
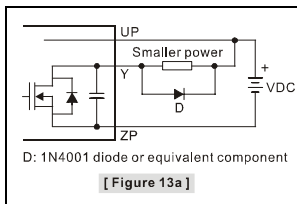

- ① DC power supply ② Emergency stop ③ Circuit protection fuse
- ④ The output of the transistor model is "open collector". If Y0/Y1 is set to pulse output, the output current has to be bigger than 0.1 A to ensure normal operation of the model.
1. Diode suppression: Used when in smaller power [Figure 13a]
 2. Diode + Zener suppression: Used when in larger power and frequent On/Off [Figure 13b]
- ⑤ Manually exclusive output: For example, Y2 and Y3 control the forward running and reverse running of the motor, forming an interlock for the external circuit, together with the PLC internal program, to ensure safe protection in case of any unexpected errors.

◆ RS-485 Wiring

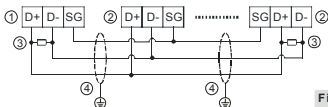

- ① Master node ② Slave node ③ Terminal resistor ④ Shielded cable

Note:

1. Terminal resistors are suggested to be connected to master and the last slave with resistor value of 120Ω.
2. To ensure communication quality, please apply double shielded twisted pair cable (20AWG) for wiring.

◆ Ethernet (RJ45) Wiring

Please use the twisted pair CAT-5e to connect the Ethernet RJ45 communication port.



① Tx+	⑤ N/C
② Tx-	⑥ Rx-
③ Rx+	⑦ N/C
④ N/C	⑧ N/C

Note: The DVP-SE series PLC is equipped with the Auto MDI/MDIX function. It does not need any jumper wire when it connects to the network device.

◆ Setting the Ethernet

The DVP-SE series PLC contains a built-in Ethernet communication port. Users have to set the network parameter before the PLC connects to other network devices. The default parameter setting values are 192.168.1.5 (the IP address) and 255.255.255.0 (the subnet mask). Users can set the parameter by using DCISoft, or by using the PLC program to write the values into the network control register (CR).

- Software: Start the DCISoft, and connect the PC to the DVP-SE series PLC through the ethernet cable. Enter "Communication Setting" page in DCISoft, and choose "Ethernet" communication port. Then, click "Search" to search for the picture representing the DVP-SE series PLC. After users click the picture twice, the setting page appears. Finally, enter the related parameters, and click "Apply" to finish the setting.
- PLC program: Users use the instruction "To" to write the IP address (CR#88, 89) and the subnet mask (CR#90, 91). For example, when the IP address is 192.168.1.5, users write 192.168 (H'COA8) into CR#89, and .1.5 into CR#88 (H'105).

Note: When users use the instruction "From/To" to read the data from the network control register and write the data into it, the module number is K108.