

User Manual

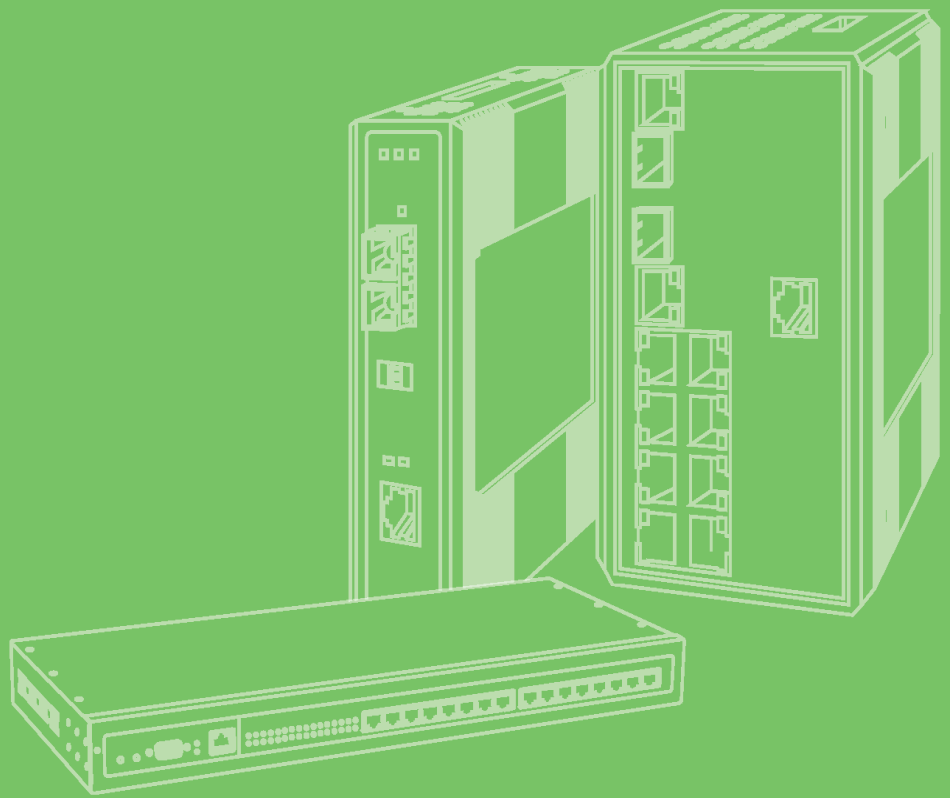

# EKI-1221, EKI-1222, EKI-1224

1/2/4-port Modbus Data Gateway

**ADVANTECH**

*eAutomation*

---

## Copyright

The documentation and the software included with this product are copyrighted 2008 by Advantech Co., Ltd. All rights are reserved. Advantech Co., Ltd. reserves the right to make improvements in the products described in this manual at any time without notice. No part of this manual may be reproduced, copied, translated or transmitted in any form or by any means without the prior written permission of Advantech Co., Ltd. Information provided in this manual is intended to be accurate and reliable. However, Advantech Co., Ltd. assumes no responsibility for its use, nor for any infringements of the rights of third parties, which may result from its use.

## Acknowledgements

Intel and Pentium are trademarks of Intel Corporation.

Microsoft Windows and MS-DOS are registered trademarks of Microsoft Corp.

All other product names or trademarks are properties of their respective owners.

## Product Warranty (2 years)

Advantech warrants to you, the original purchaser, that each of its products will be free from defects in materials and workmanship for two years from the date of purchase.

This warranty does not apply to any products which have been repaired or altered by persons other than repair personnel authorized by Advantech, or which have been subject to misuse, abuse, accident or improper installation. Advantech assumes no liability under the terms of this warranty as a consequence of such events.

Because of Advantech's high quality-control standards and rigorous testing, most of our customers never need to use our repair service. If an Advantech product is defective, it will be repaired or replaced at no charge during the warranty period. For out-of-warranty repairs, you will be billed according to the cost of replacement materials, service time and freight. Please consult your dealer for more details.

If you think you have a defective product, follow these steps:

1. Collect all the information about the problem encountered. (For example, CPU speed, Advantech products used, other hardware and software used, etc.) Note anything abnormal and list any onscreen messages you get when the problem occurs.
2. Call your dealer and describe the problem. Please have your manual, product, and any helpful information readily available.
3. If your product is diagnosed as defective, obtain an RMA (return merchandise authorization) number from your dealer. This allows us to process your return more quickly.
4. Carefully pack the defective product, a fully-completed Repair and Replacement Order Card and a photocopy proof of purchase date (such as your sales receipt) in a shippable container. A product returned without proof of the purchase date is not eligible for warranty service.
5. Write the RMA number visibly on the outside of the package and ship it prepaid to your dealer.

Part No. 2003122100

Printed in Taiwan

Edition 1

August 2008

# Declaration of Conformity

## CE

This product has passed the CE test for environmental specifications when shielded cables are used for external wiring. We recommend the use of shielded cables. This kind of cable is available from Advantech. Please contact your local supplier for ordering information.

## CE

This product has passed the CE test for environmental specifications. Test conditions for passing included the equipment being operated within an industrial enclosure. In order to protect the product from being damaged by ESD (Electrostatic Discharge) and EMI leakage, we strongly recommend the use of CE-compliant industrial enclosure products.

## FCC Class A

Note: This equipment has been tested and found to comply with the limits for a Class A digital device, pursuant to part 15 of the FCC Rules. These limits are designed to provide reasonable protection against harmful interference when the equipment is operated in a commercial environment. This equipment generates, uses, and can radiate radio frequency energy and, if not installed and used in accordance with the instruction manual, may cause harmful interference to radio communications. Operation of this equipment in a residential area is likely to cause harmful interference in which case the user will be required to correct the interference at his own expense.

# Technical Support and Assistance

1. Visit the Advantech web site at [www.advantech.com/support](http://www.advantech.com/support) where you can find the latest information about the product.
2. Contact your distributor, sales representative, or Advantech's customer service center for technical support if you need additional assistance. Please have the following information ready before you call:
  - Product name and serial number
  - Description of your peripheral attachments
  - Description of your software (operating system, version, application software, etc.)
  - A complete description of the problem
  - The exact wording of any error messages

---

## Safety Instructions

1. Read these safety instructions carefully.
2. Keep this User Manual for later reference.
3. Disconnect this equipment from any AC outlet before cleaning. Use a damp cloth. Do not use liquid or spray detergents for cleaning.
4. For plug-in equipment, the power outlet socket must be located near the equipment and must be easily accessible.
5. Keep this equipment away from humidity.
6. Put this equipment on a reliable surface during installation. Dropping it or letting it fall may cause damage.
7. The openings on the enclosure are for air convection. Protect the equipment from overheating. **DO NOT COVER THE OPENINGS.**
8. Make sure the voltage of the power source is correct before connecting the equipment to the power outlet.
9. Position the power cord so that people cannot step on it. Do not place anything over the power cord.
10. All cautions and warnings on the equipment should be noted.
11. If the equipment is not used for a long time, disconnect it from the power source to avoid damage by transient overvoltage.
12. Never pour any liquid into an opening. This may cause fire or electrical shock.
13. Never open the equipment. For safety reasons, the equipment should be opened only by qualified service personnel.
14. If one of the following situations arises, get the equipment checked by service personnel:
  - The power cord or plug is damaged.
  - Liquid has penetrated into the equipment.
  - The equipment has been exposed to moisture.
  - The equipment does not work well, or you cannot get it to work according to the user's manual.
  - The equipment has been dropped and damaged.
  - The equipment has obvious signs of breakage.
15. **DO NOT LEAVE THIS EQUIPMENT IN AN ENVIRONMENT WHERE THE STORAGE TEMPERATURE MAY GO BELOW -20° C (-4° F) OR ABOVE 60° C (140° F). THIS COULD DAMAGE THE EQUIPMENT. THE EQUIPMENT SHOULD BE IN A CONTROLLED ENVIRONMENT.**
16. **CAUTION: DANGER OF EXPLOSION IF BATTERY IS INCORRECTLY REPLACED. REPLACE ONLY WITH THE SAME OR EQUIVALENT TYPE RECOMMENDED BY THE MANUFACTURER, DISCARD USED BATTERIES ACCORDING TO THE MANUFACTURER'S INSTRUCTIONS.**
17. The sound pressure level at the operator's position according to IEC 704-1:1982 is no more than 70 dB (A).

**DISCLAIMER:** This set of instructions is given according to IEC 704-1. Advantech disclaims all responsibility for the accuracy of any statements contained herein.

<b>Chapter 1</b>	<b>Introduction.....</b>	<b>1</b>
1.1	Overview .....	2
1.2	Features .....	2
1.3	Specifications .....	3
1.4	Package Check List .....	4
<b>Chapter 2</b>	<b>Getting Started.....</b>	<b>5</b>
2.1	Understanding EKI-1221/1222/1224 .....	6
2.1.1	Protocol Overview .....	6
	Figure 2.1 Modbus System Architecture 1 .....	7
	Figure 2.2 Modbus System Architecture 2 .....	7
2.1.2	Modbus RTU .....	8
2.1.3	Modbus ASCII .....	8
	Table 2.1: Comparison of Modbus RTU and ASCII Modes .....	8
2.1.4	Modbus TCP .....	8
2.2	Hardware .....	9
2.2.1	LED Indicators .....	9
	Table 2.2: EKI-1221/1222/1224 LED Indicators .....	9
2.2.2	Dimensions (Units: mm) .....	10
	Figure 2.3 Front View of EKI-1221 .....	10
	Figure 2.4 Side View of EKI-1221 .....	10
	Figure 2.5 Back View of EKI-1221 .....	11
	Figure 2.6 Top View of EKI-1221 .....	11
	Figure 2.7 Front View of EKI-1222 .....	12
	Figure 2.8 Side View of EKI-1222 .....	12
	Figure 2.9 Back View of EKI-1222 .....	13
	Figure 2.10 Top View of EKI-1222 .....	13
	Figure 2.11 Front View of EKI-1224 .....	14
	Figure 2.12 Side View of EKI-1224 .....	14
	Figure 2.13 Back View of EKI-1224 .....	15
	Figure 2.14 Top View of EKI-1224 .....	15
2.3	Connecting Hardware .....	16
2.3.1	Choosing the Location .....	16
	Figure 2.15 Combine the Metal Mounting Kit .....	16
	Figure 2.16 DIN-rail Step 1 .....	17
	Figure 2.17 DIN-rail Step 2 .....	17
2.3.2	Connecting Power .....	18
	Figure 2.18 Power Connector .....	18
2.3.3	Connecting Serial Devices .....	18
	Figure 2.19 EKI-1221/1222/1224 Serial Port Pin Assignments ...	18
2.3.4	Connecting to a Host or the Network .....	18
<b>Chapter 3</b>	<b>Configuration .....</b>	<b>19</b>
3.1	Installing the Configuration Utility .....	20
3.2	Starting the Configuration Utility .....	23
3.3	Discovering Modbus Data Gateways .....	24
	3.3.1 Auto Searching .....	24
	3.3.2 Clear Device List and Search Again .....	27
	3.3.3 Manual Appending .....	27
3.4	Setting Ethernet Parameters .....	28
3.5	Setting Serial Communication Parameters .....	29
	3.5.1 Basic Configuration .....	30
	3.5.2 Operation Configuration .....	32
3.6	Function Accessible Setting .....	34
3.7	Monitoring Modbus Status .....	35

---

3.8	Administrator Setting.....	35
3.8.1	Import/Export Serial Port Setting .....	36
3.8.2	Locate the Modbus Data Gateway .....	36
3.8.3	Lock Device .....	37
3.8.4	Restore to Factory Default Settings.....	38
3.8.5	Update Firmware .....	39

# Chapter 1

Introduction

---

## 1.1 Overview

Advantech's EKI-1200 series of Modbus Data Gateways are a robust, feature-rich, and cost effective way to integrate of Ethernet and Serial Modbus devices. The EKI-1221/1222/1224 provides one, two or four serial ports, two switched Ethernet ports, a wide range of power inputs, and a compact slim design, making them an ideal solution for connecting multiple Modbus/RTU and Modbus/ASCII serial devices to Modbus TCP (Ethernet).

Originally developed for PLCs in industrial automation and manufacturing control applications, Modbus is one of the most popular open standard protocols in use today. The communication mode can be Modbus RTU/ASCII (Serial) or Modbus TCP (Ethernet). Many industrial devices use Modbus as their communication standard. However, the Ethernet-based Modbus protocol is different from the original serial-based protocols that a Modbus Data Gateway is needed to be a bridge for integration.

The two Ethernet ports allow the EKI-1221/1222/1224 to establish two separated Ethernet connections to two Ethernet domains or two Ethernet switches in the same domain. Through a dual Ethernet connection, the EKI-1221/1222/1224 greatly improves the device connectivity reliability, increase system stability, and simplify the redundant configuration.

The Modbus/RTU and Modbus/ASCII protocols define how a "master" device polls one or more "slave" devices and write real-time data over RS-232, RS-422, or RS-485 serial data communication. The EKI-1221/1222/1224 provides a feature that can allow users to select master or slave operation for each serial port. EKI-1221/1222/1224 not only allows Ethernet master can control serial slaves, but it can also allow serial masters to control Ethernet slaves. Further more, the EKI-1221/1222/1224 can allow both Ethernet and serial slaves to be controlled by both Ethernet and serial masters.

The EKI-1221/1222/1224 provides various operation modes: RTU Master, RTU Slave, ASCII Master, and ASCII Slave.

## 1.2 Features

- Provides dual 10/100 Mbps auto-sensing Ethernet ports
- Compact design without any hardware configuration
- Integration of Modbus TCP and Modbus RTU/ASCII networks
- Supports baud rate up to 921.6 Kbps
- Support up to 16 connections and 32 requests simultaneously
- Supports 31 slaves per serial port
- Provides easy to use configuration utility
- Software selectable RS-232/422/485 communication
- Auto searching slave ID over configuration utility
- Surge protection for RS-422/485 line and power input
- Mounts on DIN-rail, wall, or panel



## 1.3 Specifications

### LAN

- Speed: 10/100 Mbps auto sensing
- No. of Ports: 2
- Port Connector: RJ45 x 2 (with LED)
- Protection: Built-in 1.5 KV magnetic isolation

### Serial Interface

- Port Type: RS-232/422/485, software selectable
- No. of Ports:
  - EKI-1221: 1
  - EKI-1222: 2
  - EKI-1224: 4
- Port Connector: DB9 (Male)
- Baud Rate: 50 bps to 921.6 Kbps
- Parity: None, Odd, Even, Space, Mark
- Data Bits: 7, 8
- Stop Bits: 1, 2
- Flow Control: RTS/CTS, XON/XOFF, DTR/DSR
- Signals:
  - RS-232: TxD, RxD, CTS, RTS, DTR, DSR, DCD, RI, GND
  - RS-422: TxD+, TxD-, RxD+, RxD-, GND
  - RS-485: Data+, Data-, GND
- Protection: 15 KV ESD for all signals, enhanced protection for RS-422/485 lines

### Software

- Utility: Advantech Serial Device Server Configuration Utility
- OS Support: Windows 2000/XP/Vista (x86)
- Operation Mode: RTU Master, RTU Slave, ASCII Master, ASCII Slave

### General

- LED indicators:
  - System: Power1, Power2, System Status
  - LAN: Speed, Link/Active
  - Serial: Tx, Rx

### Power

- Power input: 12 to 48 VDC x 2
- Power connector: Terminal block
- Power Consumption:
  - EKI-1221: 2W
  - EKI-1222: 2.5W
  - EKI-1224: 4W
- Power Line Protection: 1 KV burst (EN61000-4-4), 0.5 KV surge (EN51000-4-5)

---

### **Environmental**

- Operating Temperature: 0 to 60 °C (32 to 140 °F)
- Storage Temperature: -20 to 85 °C (-4 to 185 °F)
- Operating Humidity: 5 to 95 % RH

### **Regulatory Approvals**

- ECM: CE Class A, FCC Part 15 Subpart B Class A
- Safety: UL (UL60950-1)

## **1.4 Package Check List**

- One EKI Modbus Data Gateway
- Panel mounting bracket
- CD-ROM for configuration utility and user manual

# Chapter 2

Getting Started

---

## 2.1 Understanding EKI-1221/1222/1224

Networks have become increasingly vital for industrial automation applications. Many control devices today do not have a network port and can only communicate with a dedicated local PC or control panel. Advantech's revolutionary network-enabling technology is now allowing control devices with serial ports to connect to the Ethernet and share networks quickly and cost-effectively. The EKI-1221/1222/1224 is network-based, Modbus data gateway for integrating new and existing Modbus/RTU and Modbus/ASCII serial devices to newer TCP/IP networked-based devices. Manufacturers, system integrators, and end users can now take advantage of the EKI-1221/1222/1224 to create networked applications for remote managing and accessing data for their control devices that wasn't possible before.

### 2.1.1 Protocol Overview

Originally developed for PLCs in industrial automation and manufacturing control application, Modbus has become one of the most popular open standard protocols in use today. When it comes to planning data communication for open, multi-vendor industrial control systems, Modbus is the first choice of end-users and integrators. Although it's not the most powerful protocol available, its rare simplicity allows not only rapid implementation, but also remains flexible enough to be applied in virtually all industrial situations. The communication mode of Modbus can be ASCII, RTU, or TCP/IP. The EKI-1221/1222/1224 is used to support applications such as protocol conversion between serial (Modbus/ASCII or Modbus/RTU) and networked (Modbus/TCP) Modbus devices or it can be used to bridge Modbus serial devices over TCP/IP network.

The Modbus/RTU and Modbus/ASCII protocols define how a "master" device polls one or more "slave" devices to read and write real-time data over RS-232, RS-422, or RS-485 serial data communication. The simplicity of Modbus/RTU not only allows rapid implementation, but can also remain flexible enough to be applied in virtually all industrial situations.

During Modbus network communication, the protocol determines how each controller will know its device address, recognize a message addressed to it, determine the kind of action to be taken, and extract any data or other information contained in the message. If a reply is required, the controller will construct the reply message and send it back using Modbus protocol.

The way controllers communicate with each other is by using a master-slave technique, in which only one device (the master) can initiate queries. The other devices (the slaves) respond by supplying the requested data to the master, or by taking the action requested in the query. Typical master devices include host processors and programming panels. Typical slaves include programmable controllers.

It is the master that can address individual slaves and initiate a broadcast message to all slaves. On the other hand, slaves return a response to queries that are addressed to them individually. Responses are not returned to broadcast queries from the master.

The Modbus protocol has a definite format for the master's query, which incorporates the device (or broadcast) address, a function code defining the requested action, any data to be sent, and an error-checking field. The slave's response message, which is also constructed using Modbus protocol, contains fields confirming the action taken, any data to be returned, and an error-checking field. If an error occurred in receipt of the message, or if the slave is unable to perform the requested action, the slave will construct an error message and send it as its response.

The basic system architecture is as below:

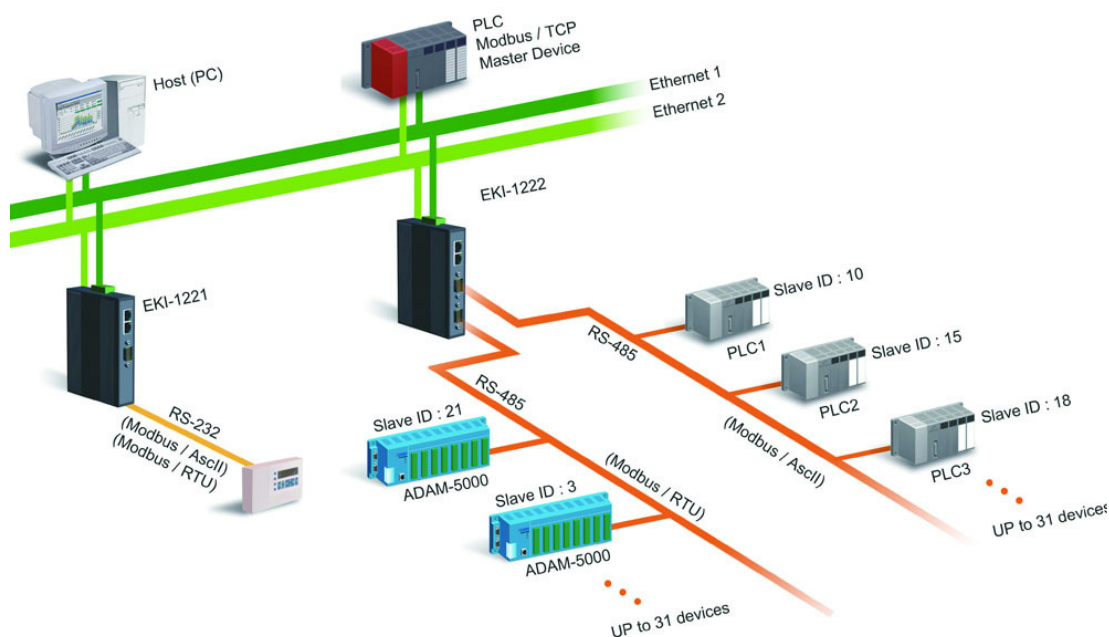

**Figure 2.1 Modbus System Architecture 1**

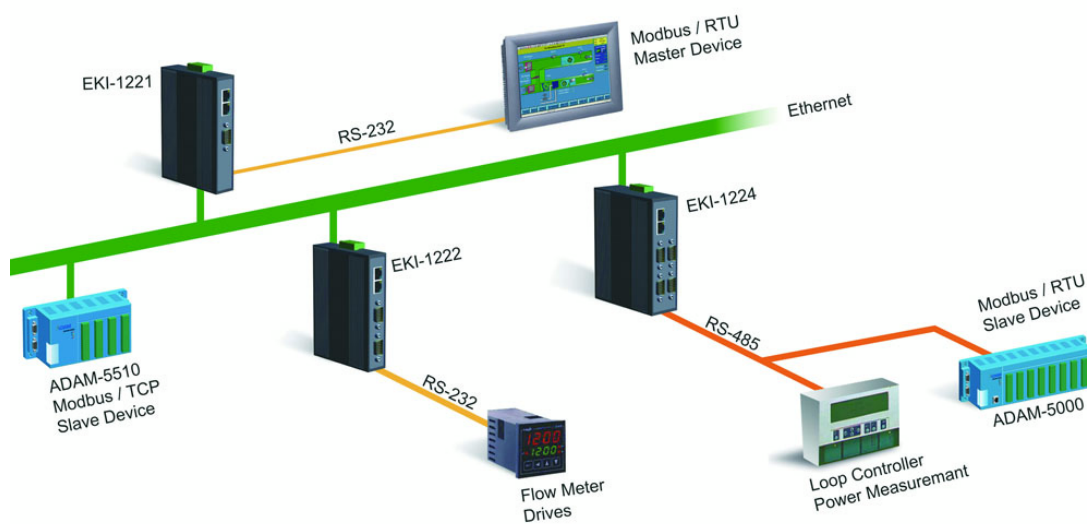

**Figure 2.2 Modbus System Architecture 2**

## 2.1.2 Modbus RTU

The Modbus/RTU protocol defines how a “master” device polls one or more “slave” devices to read and write data in real-time over RS-232, RS-422, or RS-485 serial data communication.

When using RTU mode, each 8-bit byte in a message contains two 4-bit hexadecimal characters. The main advantage of this mode is that its greater character density allows better data throughput than ASCII mode for the same baud rate. Nevertheless, each message must be transmitted in continuous stream.

## 2.1.3 Modbus ASCII

When using ASCII mode, each 8-bit byte in a message is sent as two ASCII characters. The primary advantage of this ASCII mode is that it allows time intervals of up to one second to occur between characters without causing an error.

**Table 2.1: Comparison of Modbus RTU and ASCII Modes**

Mode	RTU	ASCII
Coding System	8-bit binary. Two hexadecimal character contained in each ASCII character of the message	Hexadecimal. One hexadecimal character contained in each ASCII character of the message
Bits per Byte	1 start bit, 8 data bits, 1 bit for even/odd parity; no bit for parity 1 stop bit if parity is used; 2 bits if no parity	1 start bit , 7 data bits, 1 bit for even/odd parity; no bit for parity 1 stop bit if parity is used; 2 bits if no parity
Error Check	CRC	LRC

## 2.1.4 Modbus TCP

As a new extension of Modbus/RTU, the Modbus/TCP protocol defines how Modbus/RTU messages are encoded within and transported over TCP/IP-based networks. Modbus/TCP is just as simple to implement and flexible to apply as the original Modbus/RTU. The Modbus/TCP protocol is defined by its form of encapsulation for a Modbus request or response. That means the Modbus request or response data is encapsulated in TCP frame that has a six-byte header in Modbus/TCP protocol.

Modbus/TCP enables the use of Modbus messaging in an Intranet running the TCP/IP protocols. Modbus/TCP is most commonly used for Ethernet attachment of PLC's or I/O modules to other simple field buses or I/O networks.

## 2.2 Hardware

The following instructions will give the overview of EKI-1221/1222/1224 hardware and its installation.

### 2.2.1 LED Indicators

There are LEDs display the two sets of power status, system status, dual networks status, and serial communication status on the front panel of EKI-1221, EKI-1222, and EKI-1224. Each of them has its own specific meaning as below table.

**Table 2.2: EKI-1221/1222/1224 LED Indicators**

LED Name	LED Color	LED Description
P1	Green	Power 1 is on.
	Off	Power 1 is off, or power error condition exists.
P2	Green	Power 2 is on.
	Off	Power 2 is off, or power error condition exists.
Status	Orange	Blinking: System is ready. Steady on: The device server has been located by utility's locating the device function.
	Off	System is not working.
Ethernet	Orange	Blinking: Ethernet port is transmitting or receiving data. Steady on: Ethernet has the good link for 10Mbps or 100Mbps operations.
	Green	On: 100Mbps Ethernet connection. Off: 10Mbps Ethernet connection.
Serial	Orange	Serial port is transmitting data.
	Green	Serial port is receiving data.
	Off	No data is transmitted or received through the serial port.

## 2.2.2 Dimensions (Units: mm)

EKI-1221:

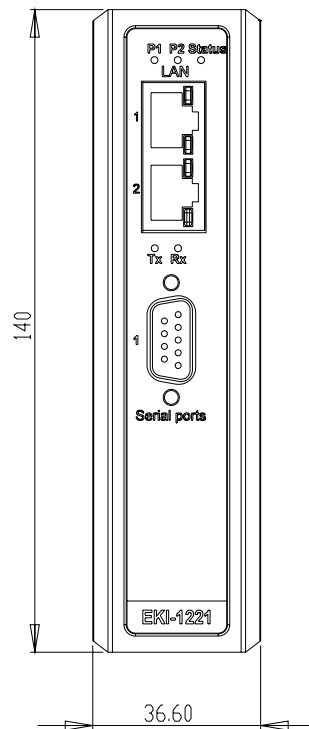

Figure 2.3 Front View of EKI-1221

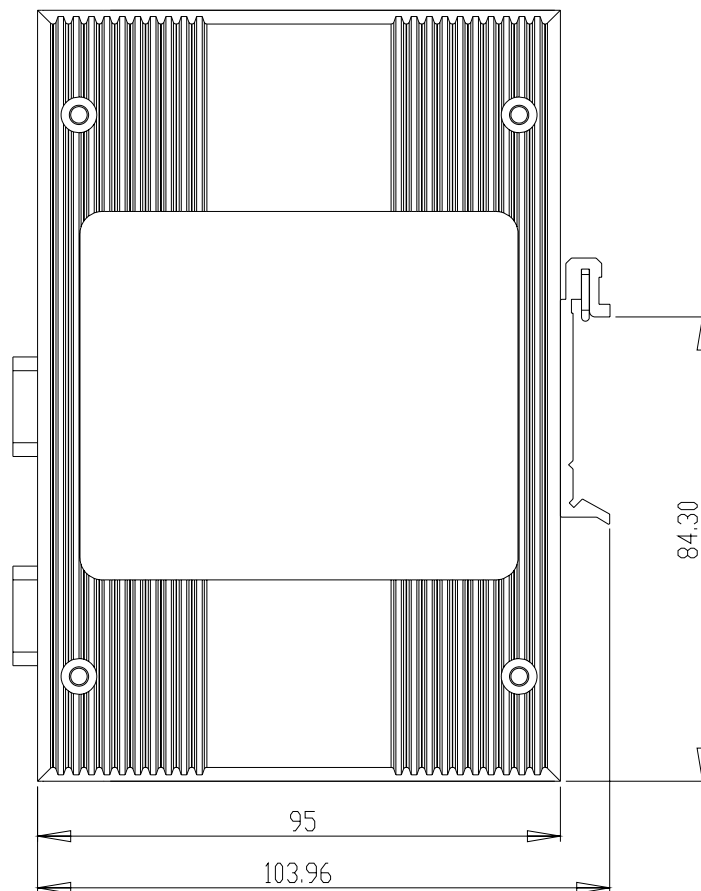

Figure 2.4 Side View of EKI-1221



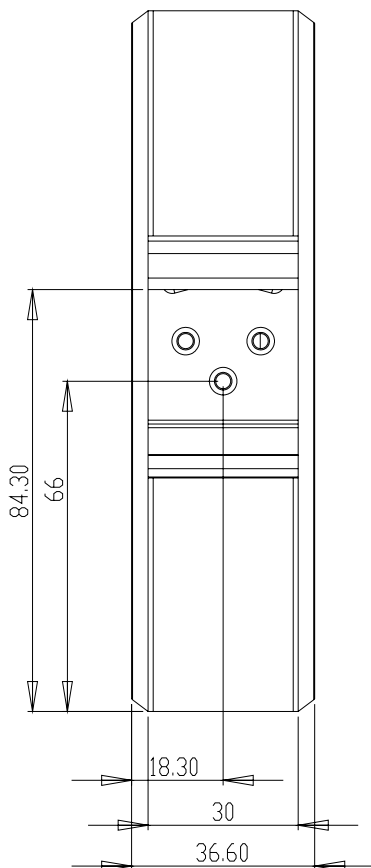

Figure 2.5 Back View of EKI-1221

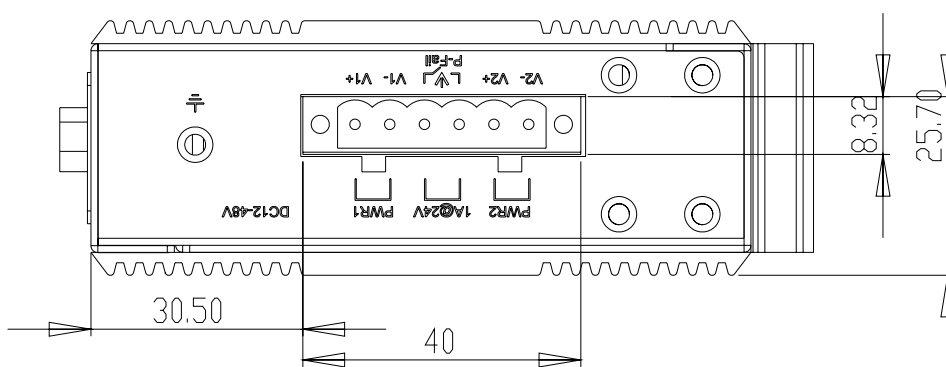
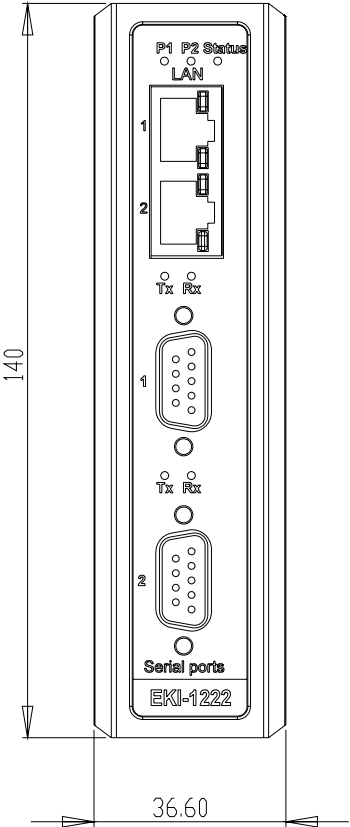
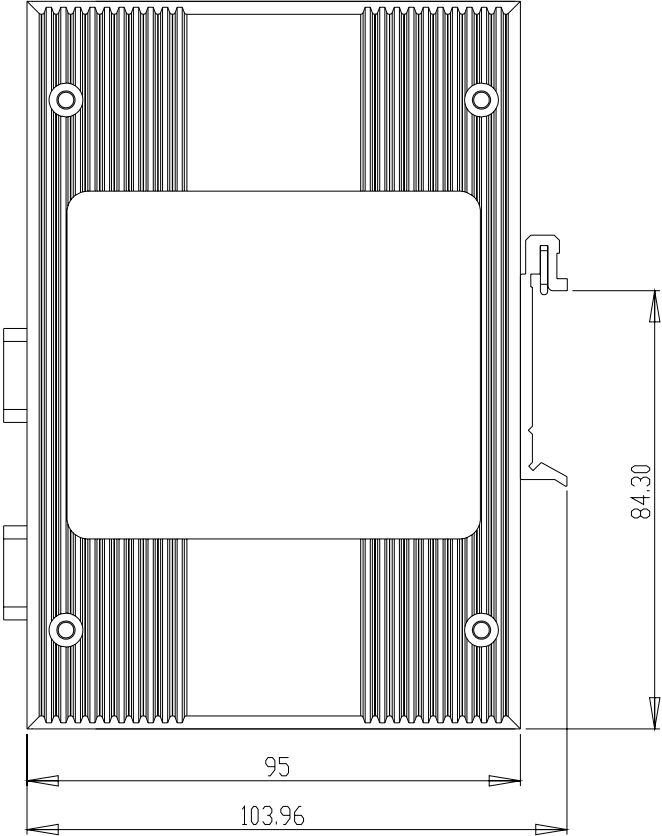

Figure 2.6 Top View of EKI-1221

**EKI-1222:**



**Figure 2.7 Front View of EKI-1222**



**Figure 2.8 Side View of EKI-1222**

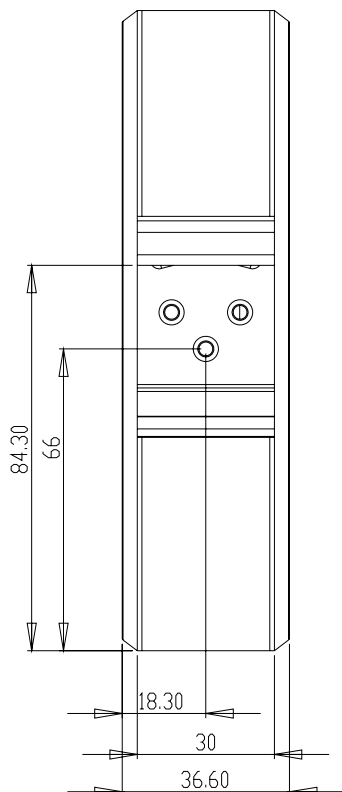

Figure 2.9 Back View of EKI-1222

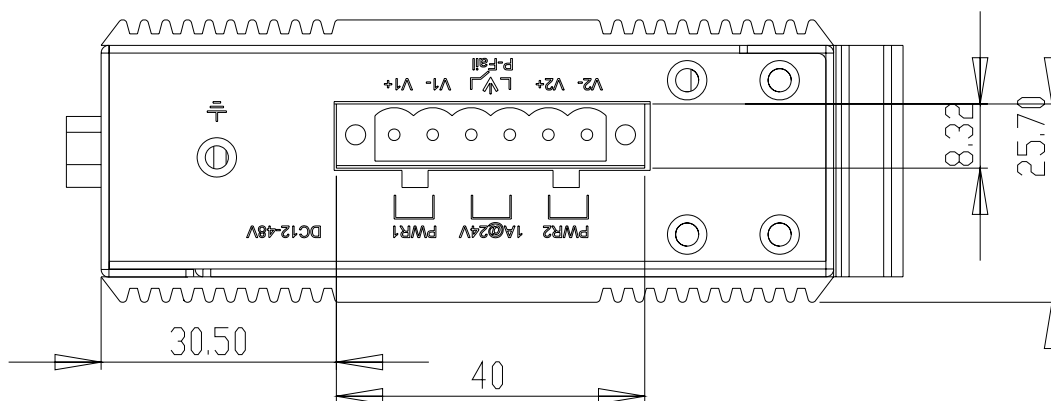
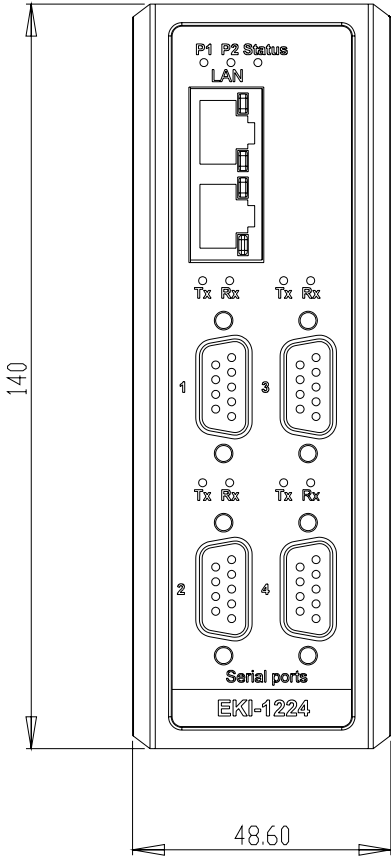
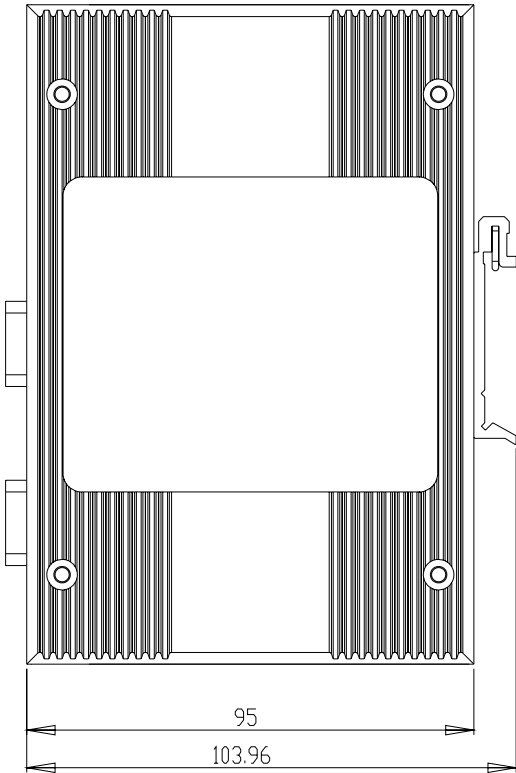

Figure 2.10 Top View of EKI-1222

**EKI-1224:**



**Figure 2.11 Front View of EKI-1224**



**Figure 2.12 Side View of EKI-1224**

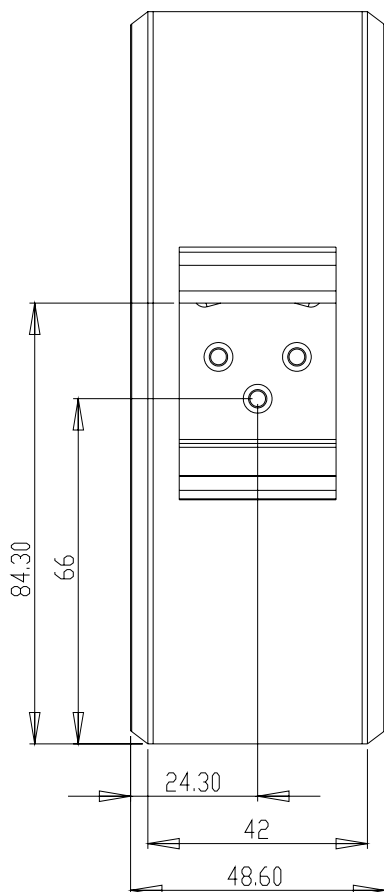

**Figure 2.13 Back View of EKI-1224**

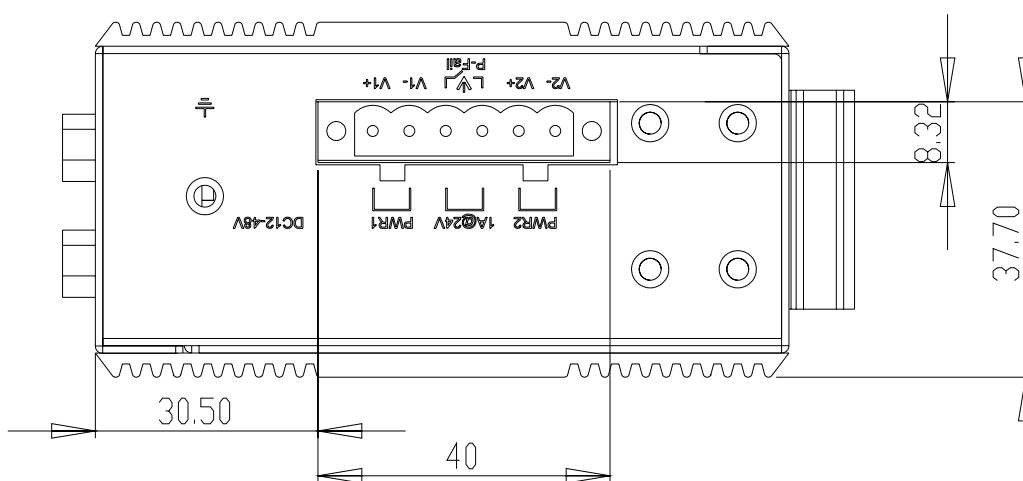

**Figure 2.14 Top View of EKI-1224**

## 2.3 Connecting Hardware

In this instruction, it will explain how to find a proper location for your EKI-1221/1222/1224, and how to connect to the network, hook up the power cable, and connect to the EKI-1221/1222/1224.

### 2.3.1 Choosing the Location

Due to its versatility and innovative design, the EKI-122/1222/1224 can be:

- Fixed to a panel mount
- Fixed to a DIN-rail

#### Panel/Wall Mounting

The EKI-1221/1222/1224 can be attached to a wall using the included metal brackets. Each bracket comes with four screws. You can install the EKI-1221/1222/1224 firmly via the components, please see the figures below.



Figure 2.15 Combine the Metal Mounting Kit

### DIN-rail Mounting

The EKI-1221/1222/1224 can be mounted on a standard DIN-rail. The DIN-rail kit is screwed on the Modbus data gateway when out of factory. If the DIN-rail kit is not screwed on the EKI-1221/1222/1224, please screw the DIN-rail kit on the Modbus data gateway first.

First, hang the EKI-1221/1222/1224 to the DIN-rail with angle of inclination. See below figure.



**Figure 2.16 DIN-rail Step 1**

Then, let the EKI-1221/1222/1224 down straight to slide over the rail smoothly.



**Figure 2.17 DIN-rail Step 2**

### 2.3.2 Connecting Power

The EKI-1221/1222/1224 supports dual +12 to 48 VDC power inputs and a power-fail relay output. Following figure is the power terminal block pin assignments. Please refer it to connect to the proper power requirements and polarity.

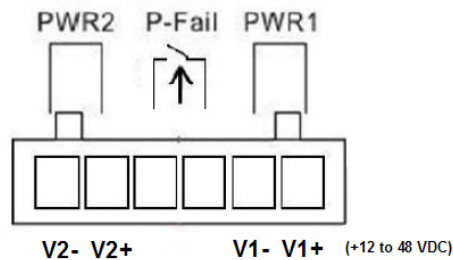
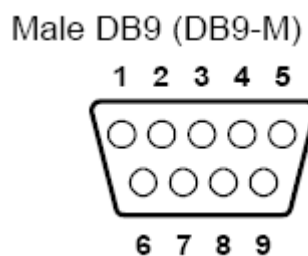

**Figure 2.18 Power Connector**

You can connect an alarm indicator, buzzer or other signaling equipment through the power-fail relay output. The relay opens if power input V1 or V2 fails. (“Open” means if you connect relay output with an LED, the light will be shut off)

### 2.3.3 Connecting Serial Devices

The EKI-1221/1222/1224 provides one, two or four standard serial ports DB9 (male) connectors. RS-232/422/485 pin assignments are as below.



**Figure 2.19 EKI-1221/1222/1224 Serial Port Pin Assignments**

Pin	1	2	3	4	5	6	7	8	9
RS-232	DCD	RX	TX	DTR	GND	DSR	RTS	CTS	RI
RS-422	TX-	-	-	TX+	GND	-	RX+	-	RX-
RS-485	Data-	-	-	Data+	GND	-	-	-	-

### 2.3.4 Connecting to a Host or the Network

The EKI-1221/1222/1224 provides two RJ45 connectors with dual independent Ethernet networks, and supports 10/100 Mbps transmission speed. The EKI-1221/1222/1224 will auto detect current transmission speed on the network and configure itself accordingly. For normal operation, the EKI-1221/1222/1224 can be connected to other hubs or switches through a twisted-pair straight through the Ethernet cable. For configuration or troubleshooting purposes, user may need to connect the EKI-1221/1222/1224 directly to the host PC. In this operation mode, user can use a crossover Ethernet cable to connect the EKI-1221/1222/1224 to the host PC’s Ethernet connector.



# Chapter 3

## Configuration

## 3.1 Installing the Configuration Utility

The following section will show you how to install Advantech Serial Device Server Configuration Utility, a tool to set up and monitor the EKI series Modbus Data Gateways.

*Note* Be sure the Microsoft .NET Framework on your host PC is greater than version 2.0 .

1. Insert the Advantech INET Series Driver Utility CD-ROM into the CD-ROM drive (e.g. E:\) on the host PC.
2. Use Windows explorer or the Windows Run command to execute the setup program, the path for the setup program on the CD-ROM should be: *E:\Utility&Driver\SerialDeviceServerConfigurationUtility\Serial\_Device\_Server\_Configuration\_Utility\_[Version]\_Release\_[date].exe*
3. If there is an existed COM port mapping utility on the host PC, you have to remove it and reboot, then go on installing.

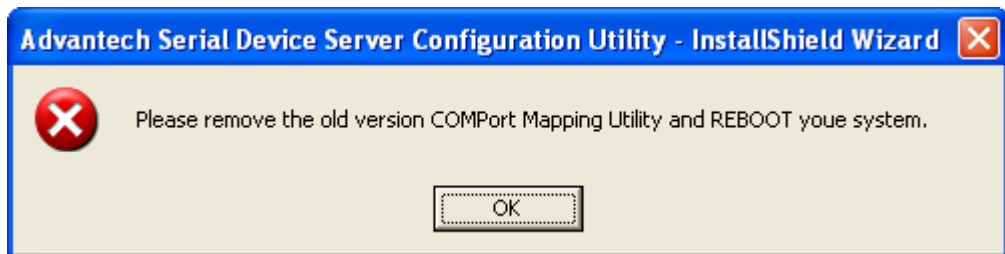

4. Once the InstallShield Wizard starts running, click "Next" when the welcome window opens to proceed with the installation.

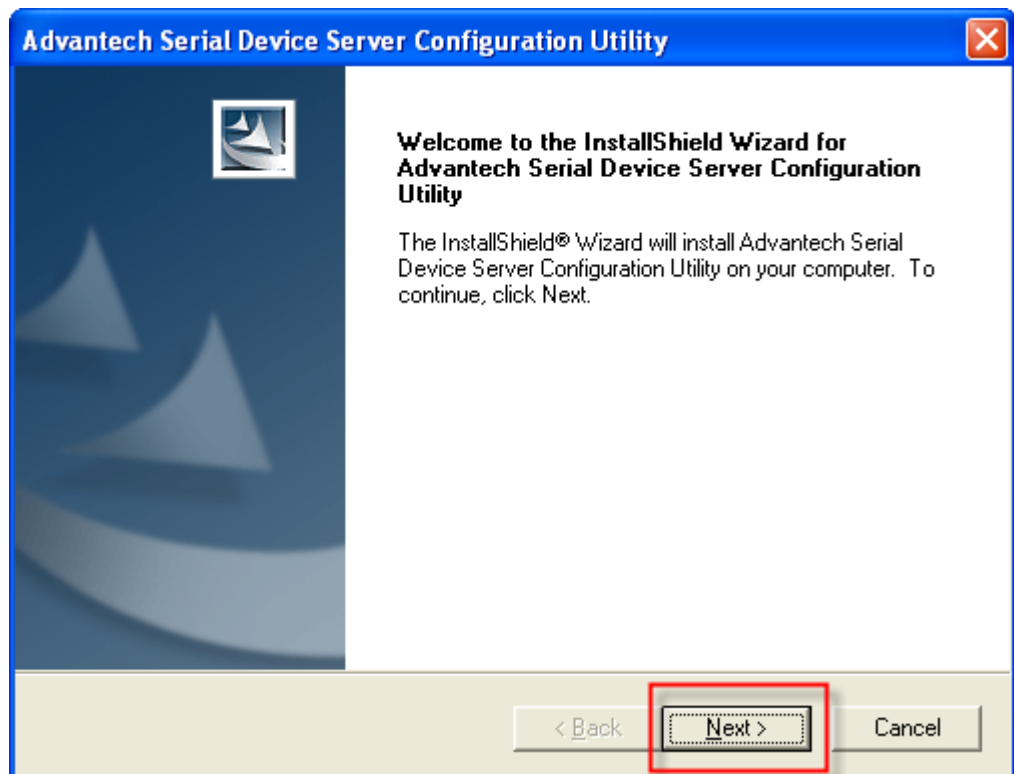

- Carefully read the Software License Agreement, and press “Yes” to continue.

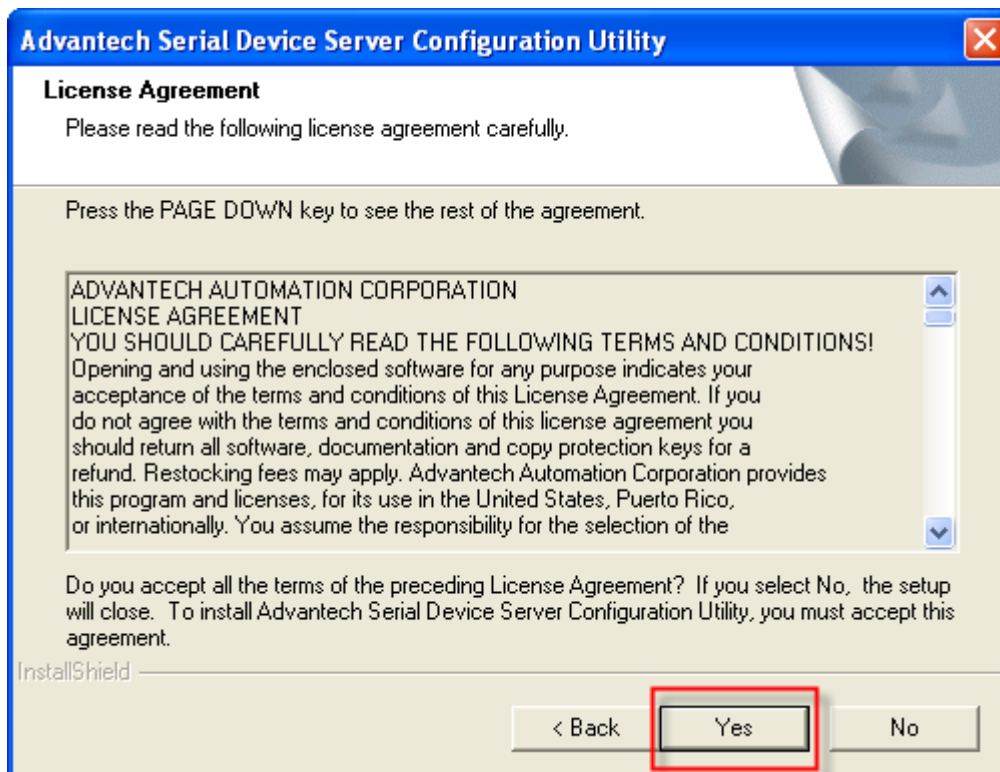

- The InstallShield will specify a default installation path, C:\Program Files\Advantech eAutomation\Serial Device Server Configuration Utility. You may change the destination directory by clicking on “Browse...” click “Next” to finish the installation.

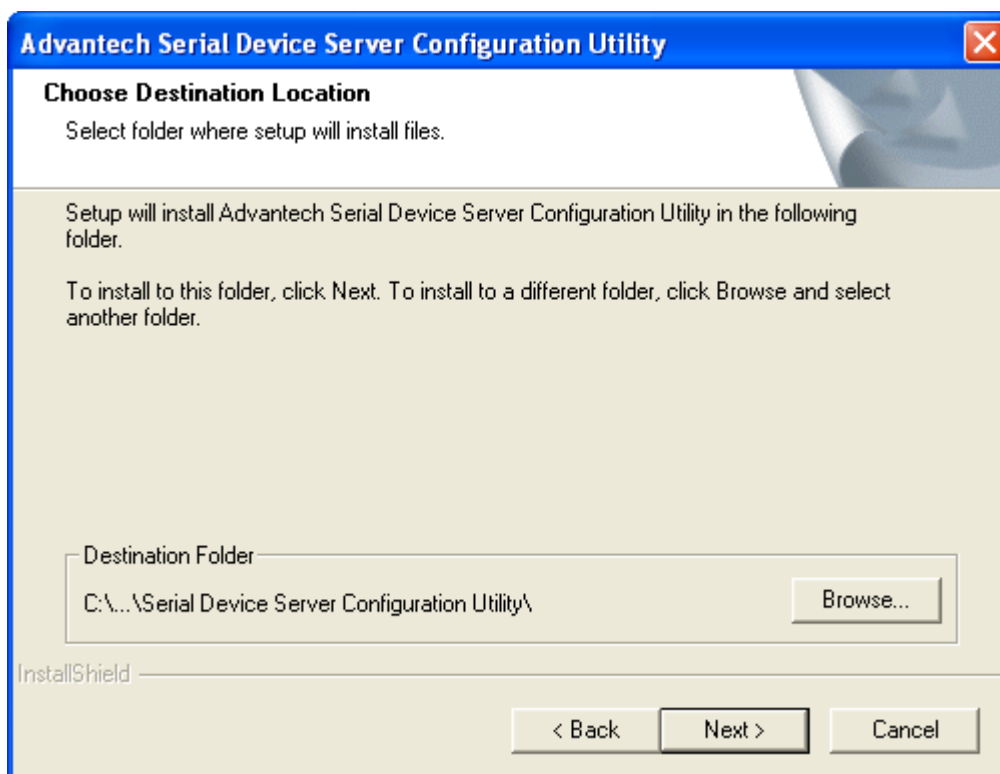

7. Click "Next" to start copying the software files.

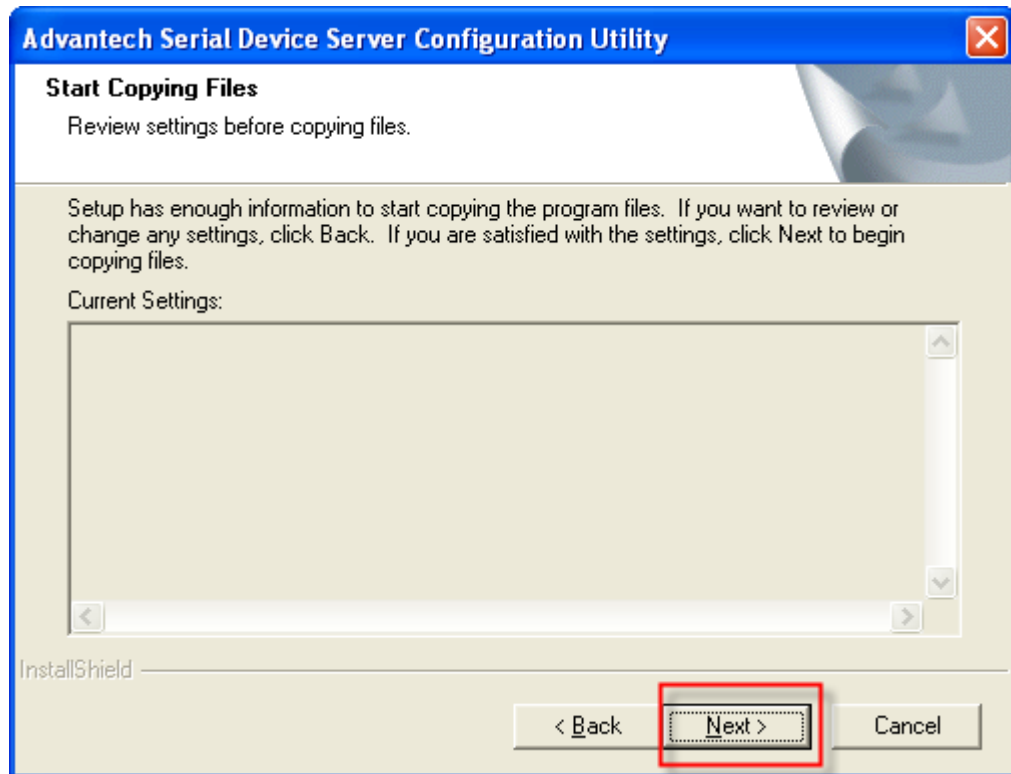

8. After few minutes, a message will indicate that Configuration Utility is successfully installed, click "Finish" to exit the InstallShield.

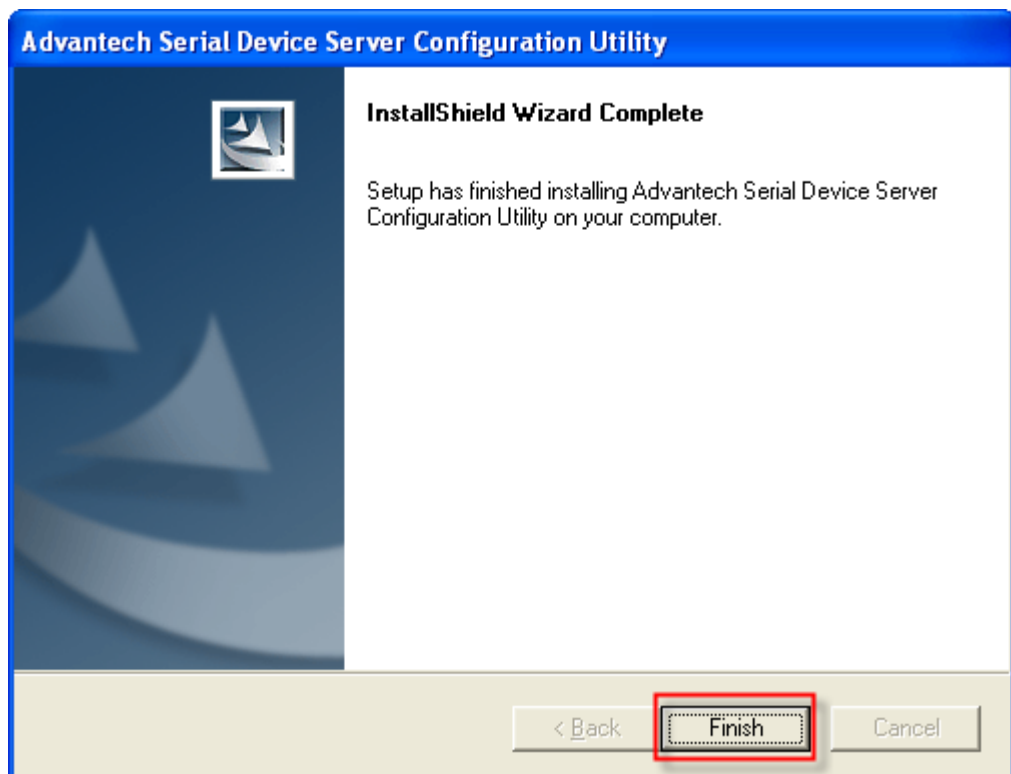

## 3.2 Starting the Configuration Utility

The EKI-1221/1222/1224 provides an easy-to-use configuration utility to configure your Modbus data gateways through an Ethernet connection. For secure administration, it can also restrict the access rights for configuration to only one host PC to enhance network security. With this secure function enabled, other PCs will not have permission for configuration. After the installation program on the Advantech IEDG Series Driver Utility CD-ROM is finished, the serial device servers will be ready for use and configure.

You may open the Serial Device Server Configuration Utility from the Windows Start Menu by clicking **Start** → **All Programs** → **Advantech eAutomation** → **Serial Device Server Configuration Utility**. The Serial Device Server Configuration Utility will appear as below figure.

There are four major areas in the new Serial Device Server Configuration Utility.

1. Serial Device Servers List Area: All devices will be searched and listed in this area. You can arrange different favorite group and virtual COM ports.
2. Serial Device Servers Information Area: Click on the devices or move cursor to the devices, the related information will be shown in this area.
3. Configuration Area: Click on the items on the Serial Device Sever List Area, the configuration page will be displayed in this area.
4. Quick Tool Bar: Useful management functions' shortcuts.

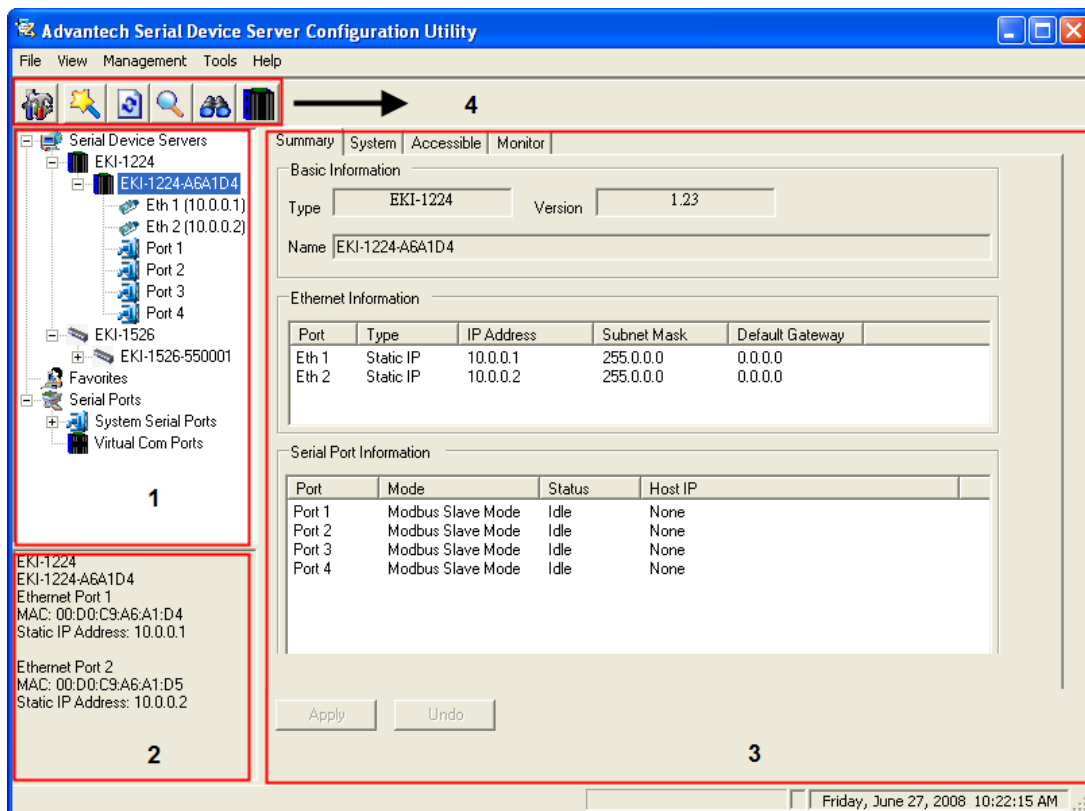

## 3.3 Discovering Modbus Data Gateways

### 3.3.1 Auto Searching

Advantech Serial Device Server Configuration Utility will automatically search all the EKI, ADAM and EDG series device servers on the network and show them on the Serial Device Server List Area of the utility. The Utility provides an auto-searching function to show your device(s) by simply executing the configuration utility program from the **Start Menu**.

From here all devices on the same network domain will be searched and display on the Serial Device Server List Area. You can click on the device name to show the features of the specific device. Click on the "+" before the model name (e.g. EKI-1224), and the utility will expand the tree structure to show the individual device name. Click on the "-" before the model name (e.g. EKI-1224), and the utility will collapse the tree structure.

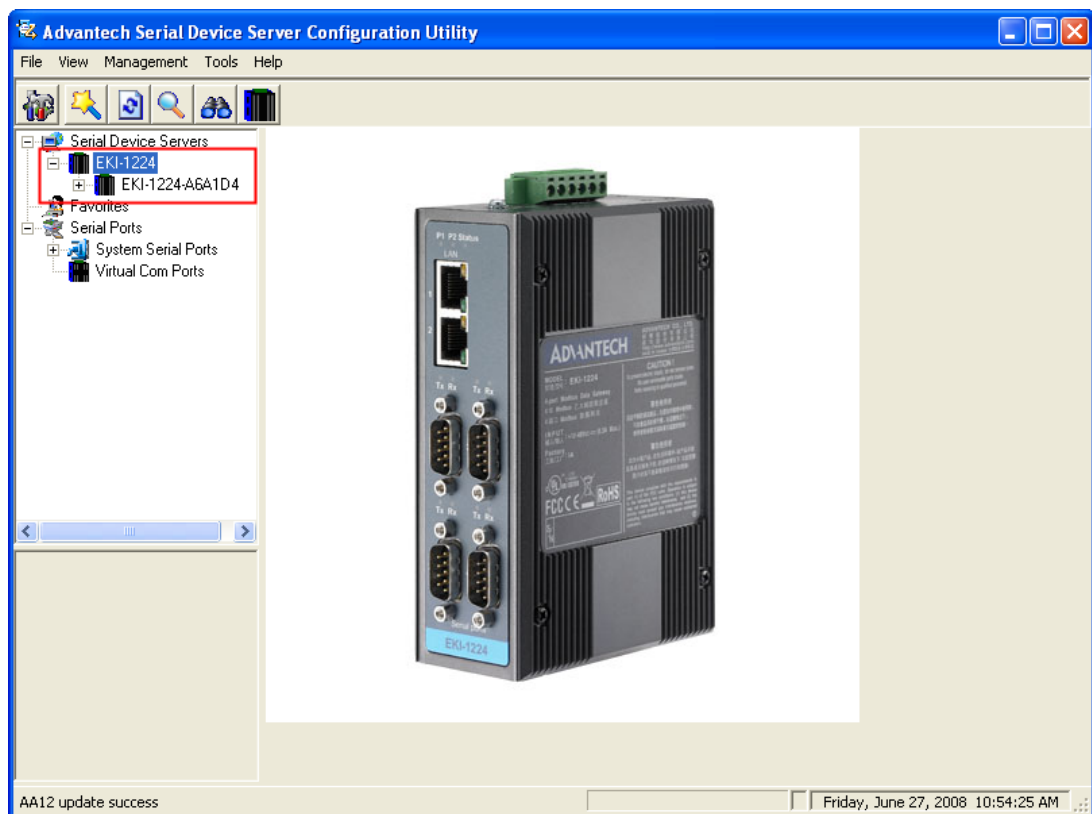

For example, EKI-1224 in this figure is shown “EKI-1224-A6A1D4” after expanding the tree structure.

**Note** When you configure the device for the first time, the default device name is “MAC ID”. In this case, the device name “EKI-1224-A6A1D4” means the device’s Mac ID is “00 D0 C9 A6 A1 D4”. You can change the device name in System Tab of Device Property.

Select the device in this sub-tree. The first tab on the “Configuration Area” shows the summary of “Basic Information” included device type, firmware version, and device name, “Ethernet Information”, and “Serial Port Information”. In the serial port information frame, it displays the operation mode, status and connected host IP.

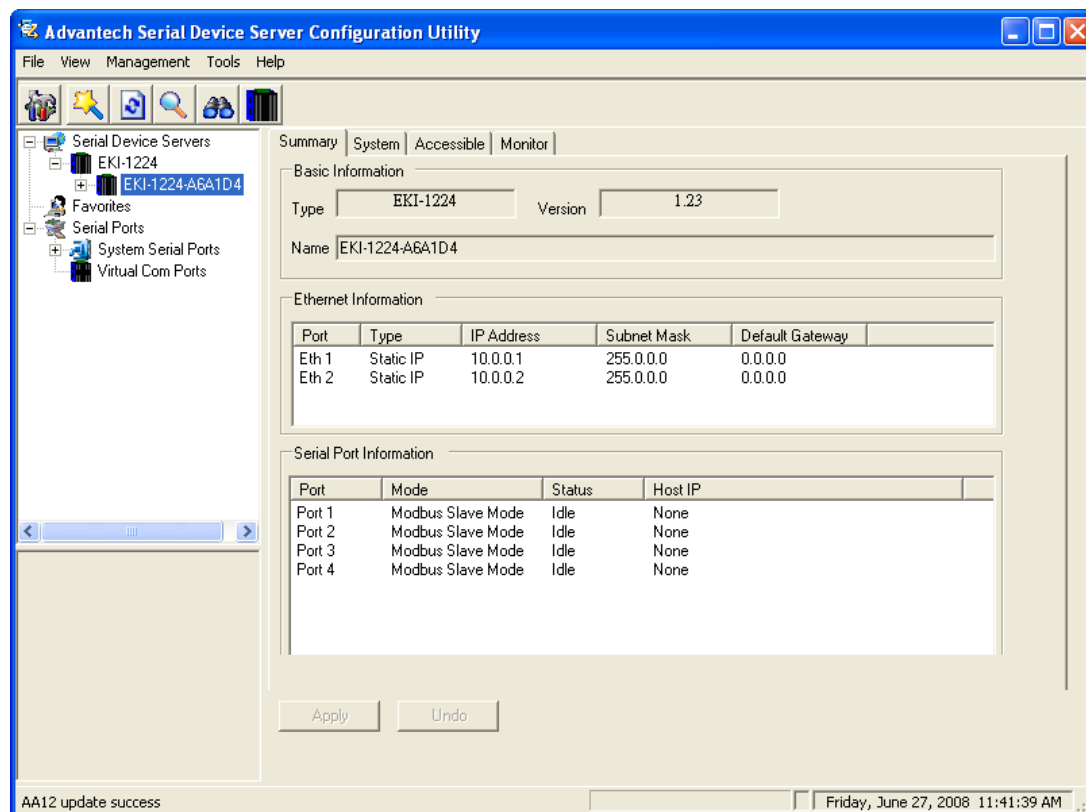

Click on the “+” before the device name, and the utility will expand the communication interfaces on this Modbus data gateway.

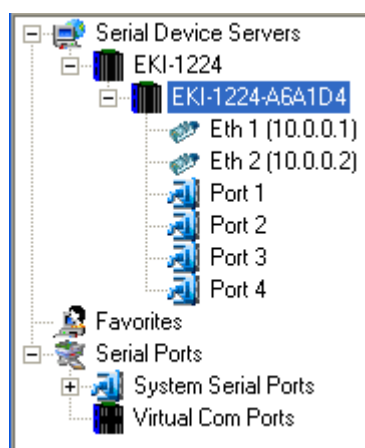

Click on each interface item, you will enter the configuration page to modify the setting. The configuration will be introduced on following sections.

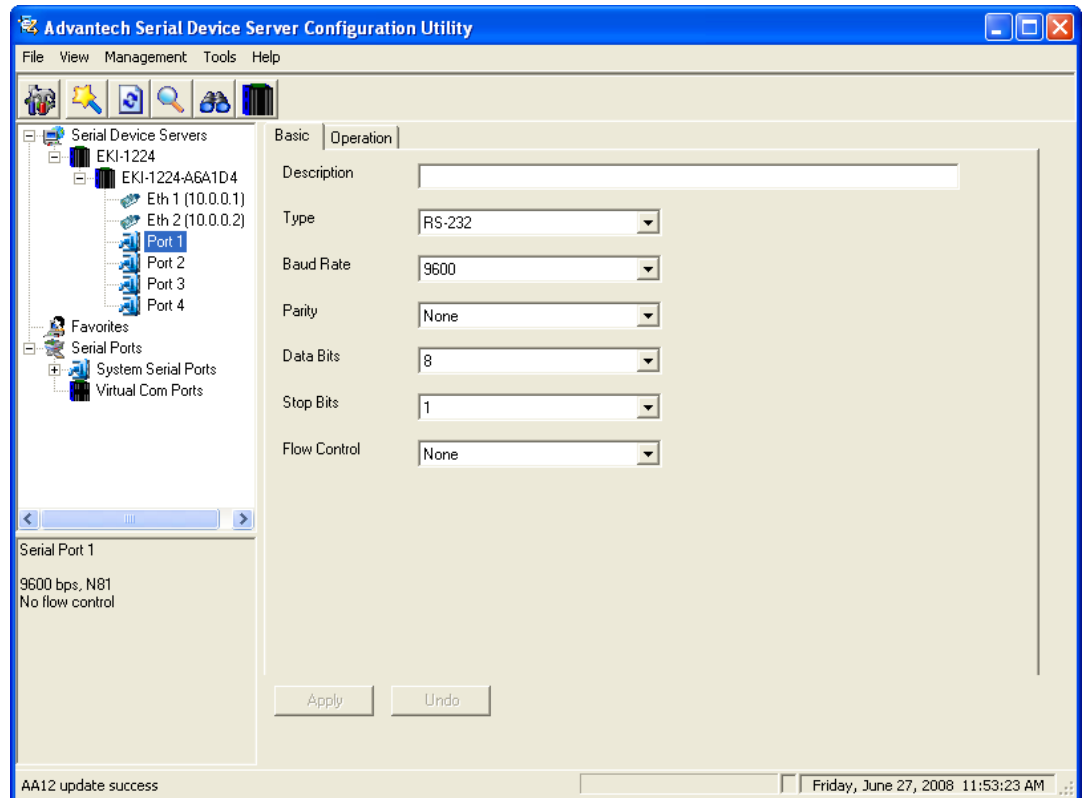
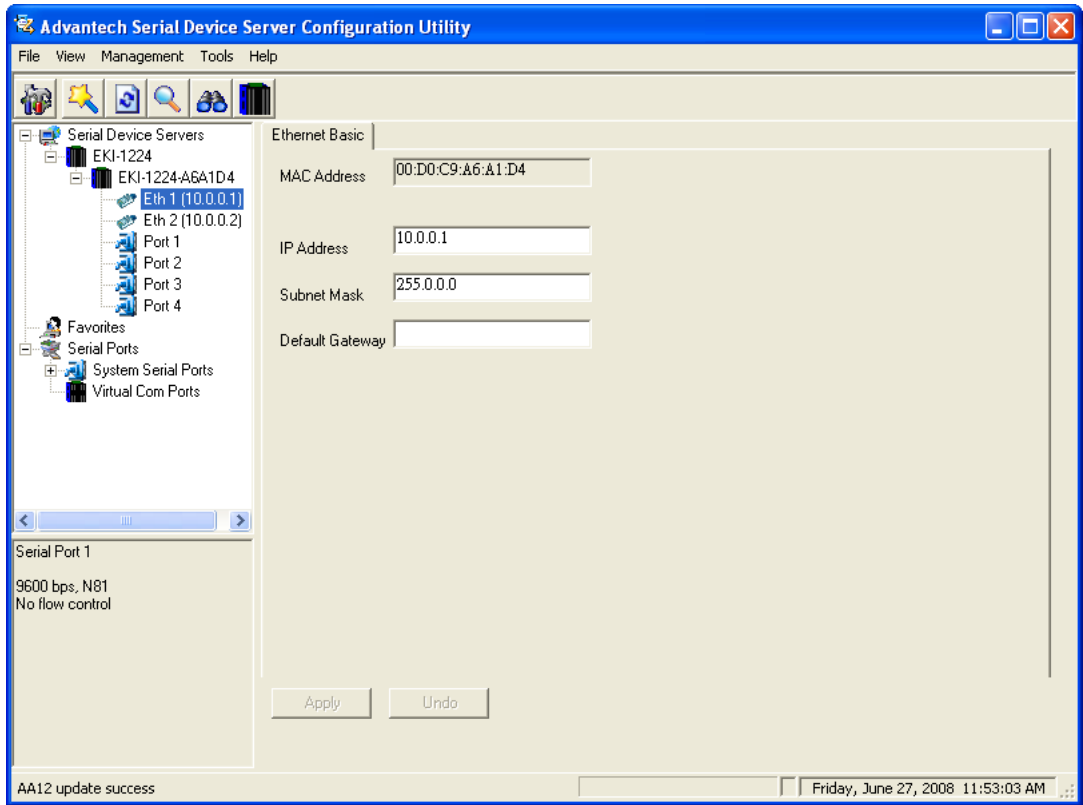



### 3.3.2 Clear Device List and Search Again

You can click the “Clear Device List and Search Again” button on the Quick Tool Bar



and the utility will clear all list device servers in the Serial Device Server List Area and re-search again. Don't use this function frequently, or the warning message will be pop-up.



You also can click the “Search Again” button on the Quick Tool Bar  and the utility will search serial device servers on the local LAN.

### 3.3.3 Manual Appending

Using “Add IP address to Favorite” or “Search a Range of IP addresses” functions, you are allowed to add one device or group of devices to “Favorites”. These devices can locate on local network domain or other network domain.

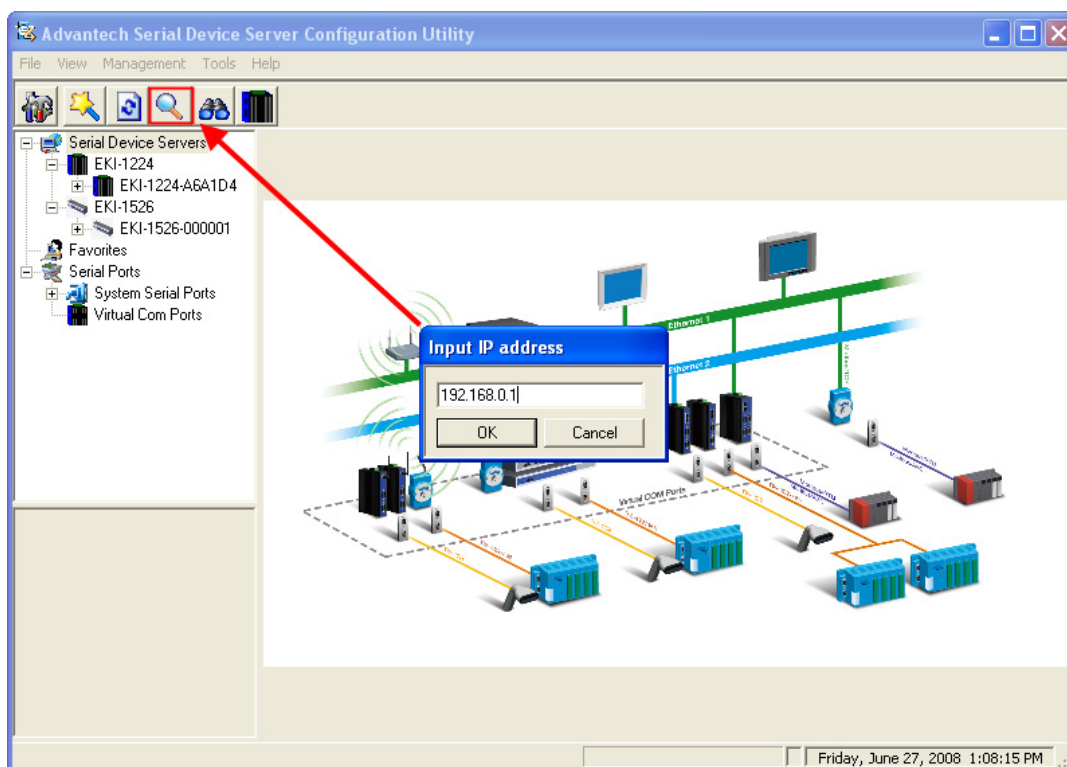

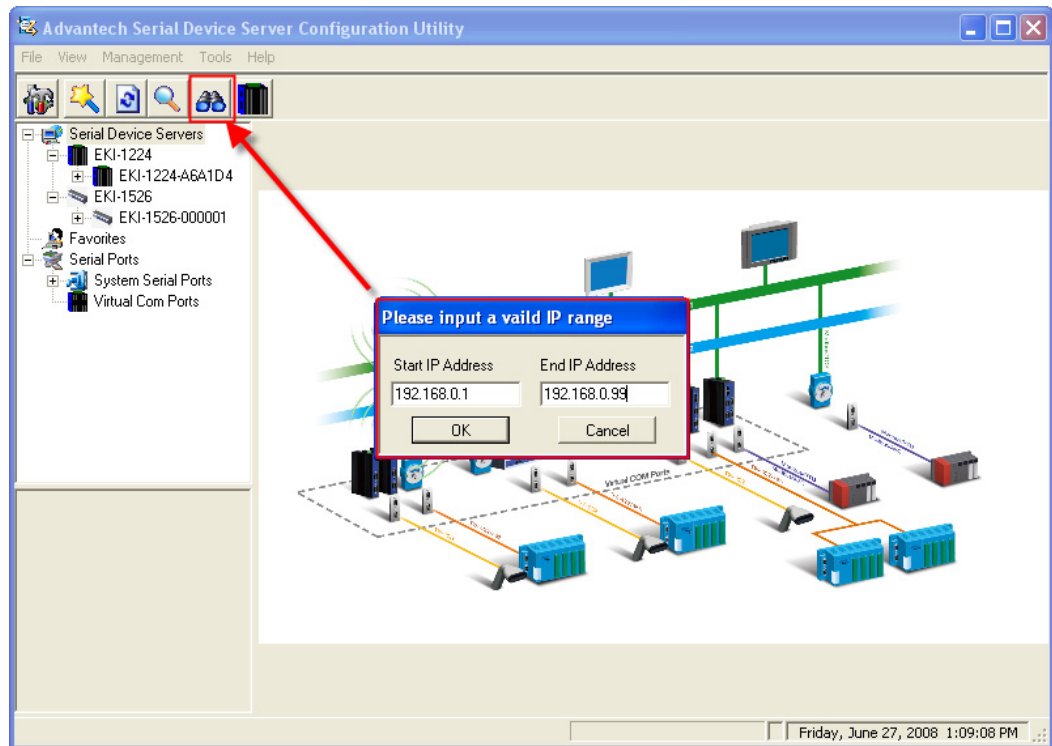

### 3.4 Setting Ethernet Parameters

Click on the “+” before the model name (e.g. EKI-1224), and the utility will expand the tree structure to show the individual device name. And click on the “+” before the device name, and utility will expand the communication interfaces on this Modbus data gateway. Select the Ethernet interface (Eth1 or Eth2, these are two individual Ethernet ports).

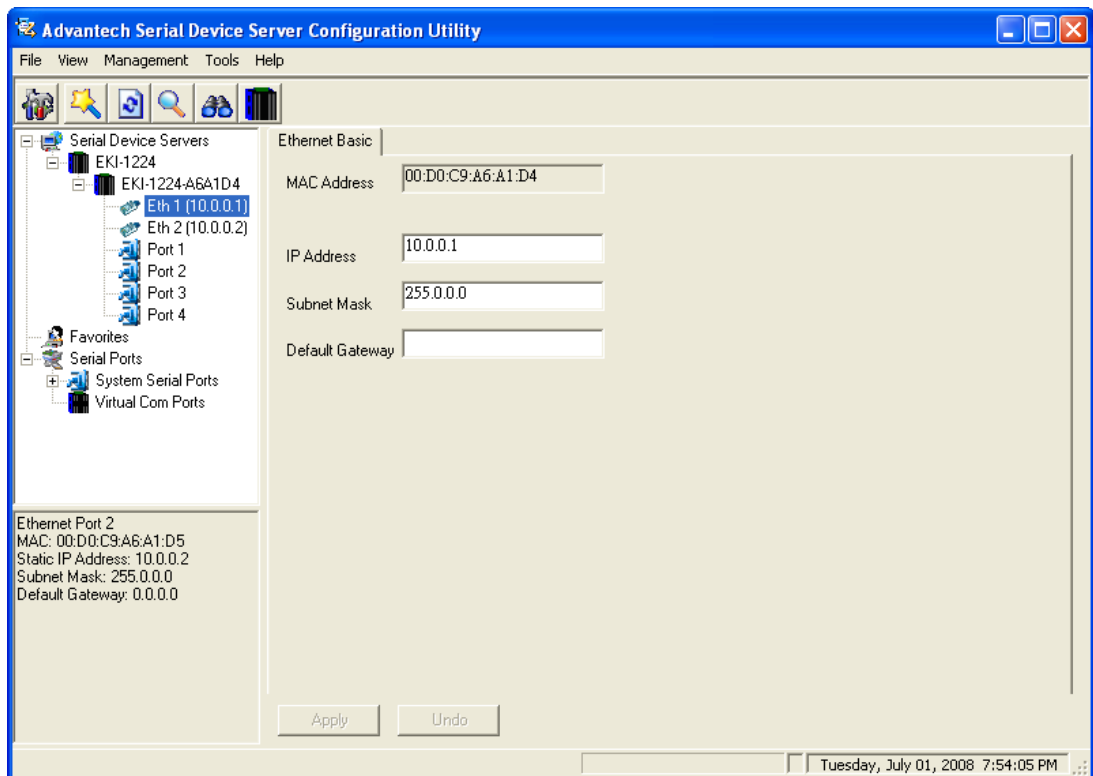

**MAC Address:**

The MAC address is for the local system to identify and locate each serial device servers. This MAC address is already set before delivery from factory, hence no need for further configuration.

**IP Address, Subnet Mask, Default Gateway:**

The IP address identifies your Modbus data gateway on the global network. Each EKI-1221/1222/1224 has the same default IP address 10.0.0.1 and 10.0.0.2 for dual Ethernet ports. Obtain these specific IP addresses from your network administrator and then configure each Advantech Modbus data gateway with individual IP addresses, related Subnet Mask and Gateway Setting.

*Note* When you have finished the configuration of these settings for each category, please press the “Apply” button in order to make these settings effective on the Modbus data gateway. (Will reboot your Modbus data gateway immediately)

## 3.5 Setting Serial Communication Parameters

Click on the "+" before the model name (e.g. EKI-1224), and the utility will expand the tree structure to show the individual device name. And click on the "+" before the device name, and the utility will expand the interfaces on this device server. Select the serial interface. (Port1 to Port4 on e.g. EKI-1224)

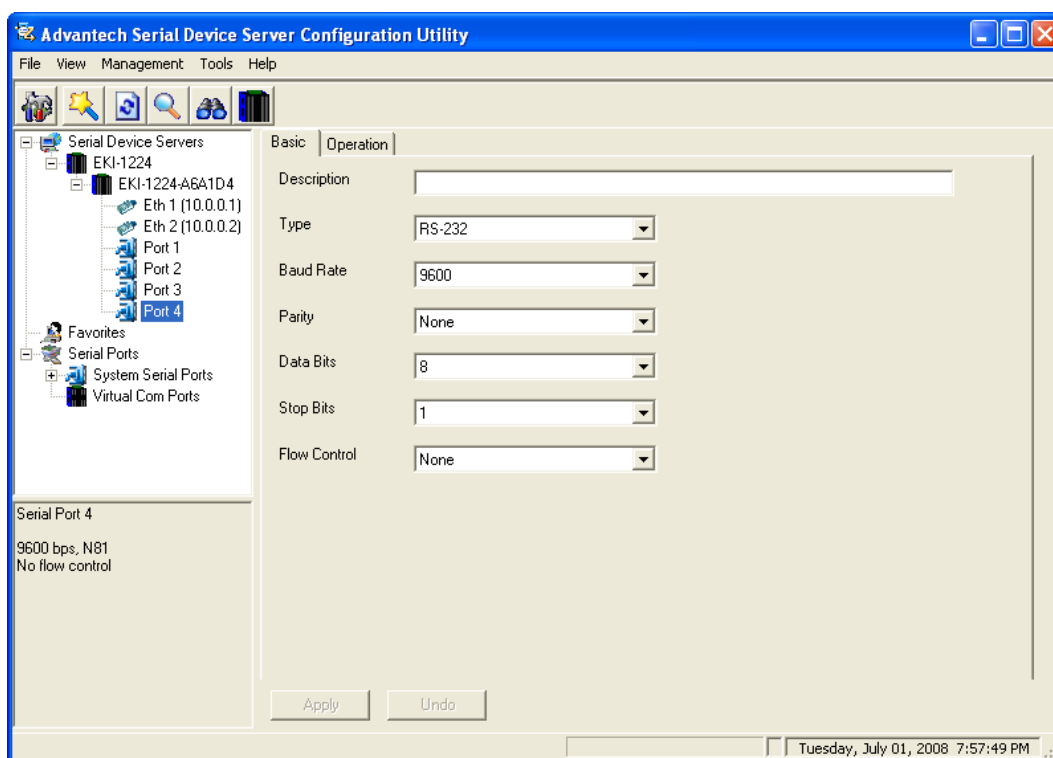

### 3.5.1 Basic Configuration

#### Description:

You can give a more detailed description on the function of the port for easier management and maintenance. Descriptions have a limit of 128 characters.

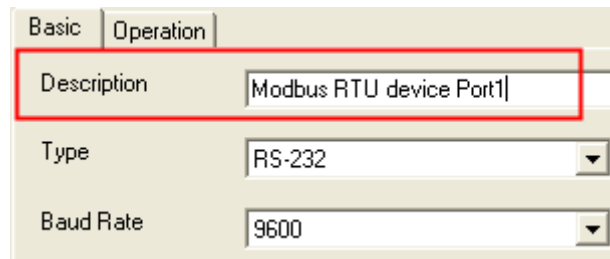

The screenshot shows the 'Basic' configuration tab with the following fields:

Description	Modbus RTU device Port1
Type	RS-232
Baud Rate	9600

#### Type:

Each EKI-1221/1222/1224 offers 3 kinds of serial interfaces, RS-232, RS-485 and RS-422. You can use any one of these serial interfaces according to your requirements. You must also pay special attention to the wiring scheme of the EKI-1221/1222/1224 serial connection to make sure it conforms to the serial type you select.

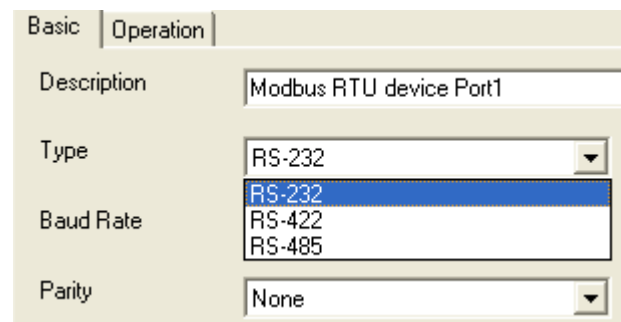

The screenshot shows the 'Basic' configuration tab with the 'Type' dropdown menu open, displaying the following options:

Description	Modbus RTU device Port1
Type	RS-232
Baud Rate	RS-232
	RS-422
	RS-485
Parity	None

#### Baud Rate:

The EKI-1221/1222/1224 supports baud rate from 50 bps to 921.6 Kbps. While setting the baud rate, please note that the value should conform to the current transmission speeds of connected devices.

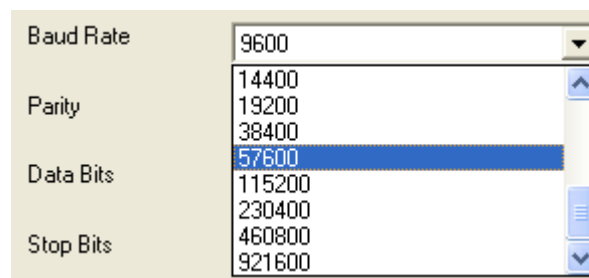

The screenshot shows the 'Baud Rate' dropdown menu with the following options:

Baud Rate	9600
Parity	14400
	19200
	38400
Data Bits	57600
	115200
	230400
Stop Bits	460800
	921600

**Parity, Data bits, Stop bits:**

The settings for these parameters depend on the protocol that is running on the connected Modbus device (i.e. Modbus/ASCII or Modbus/RTU).

Parity	None	Even or Odd
Data bits	7	7
Stop bits	2	1

**Modbus/ASCII**

Parity	None	Even or Odd
Data bits	8	8
Stop bits	2	1

**Modbus/RTU****Flow Control:**

The EKI-1221/1222/1224 provides four options: None, XOn/XOff, RTS/CTS, and DTR/DSR.

The image shows a configuration window with three dropdown menus. The first menu is labeled 'Data Bits' and is set to '8'. The second menu is labeled 'Stop Bits' and is set to '1'. The third menu is labeled 'Flow Control' and is set to 'None'. The 'Flow Control' menu is open, showing a list of options: 'None', 'XOn/XOff', 'RTS/CTS', and 'DTR/DSR'. The 'None' option is highlighted in blue.

## 3.5.2 Operation Configuration

The Operation tab is for each serial port's operation mode configuration. The operation mode determines whether the devices that are connected to the serial port will operate as a master or a slave, and whether the Modbus RTU or Modbus ASCII protocol will be used.

### Modbus Slave Mode:

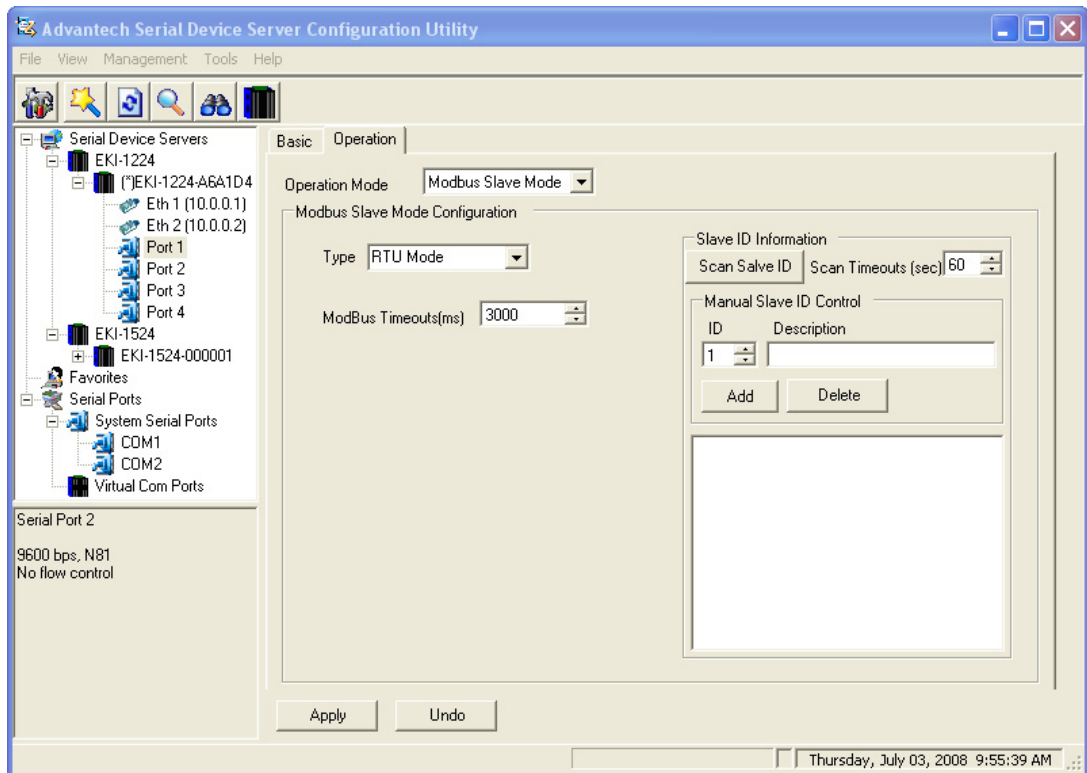

### Type:

This option specifies whether the Modbus RTU or Modbus ASCII slave devices are connected to the serial port.

### Modbus Timeouts (ms):

This option specifies the time duration in milliseconds for the EKI-1221/1222/1224 to wait for a response after it has issued a command while using Modbus/RTU or Modbus ASCII. After the timeout is expired and no response is received, the EKI-1221/1222/1224 will regard the command as failed. Note that the timeout for the host PC must be greater than the timeout setting here specified, otherwise an error will occur.

### ASCII Character Timeouts (ms):

This option specifies the time interval in milliseconds between characters within the Modbus/ASCII message. If a greater interval occurs, the receiving device assumes an error has occurred.

**Slave ID Information:**

The EKI-1221/1222/1224 features an excellent function that the utility will scan slave ID automatically. Click “Scan Slave ID” button, and the utility will start to issue the requests to the devices connected to this serial port and wait the reply about slave ID information. The “Scan Timeouts (sec)” means the time duration the utility wait for response slave ID information. Alternative option, the utility allows to manual add or delete slave ID information.

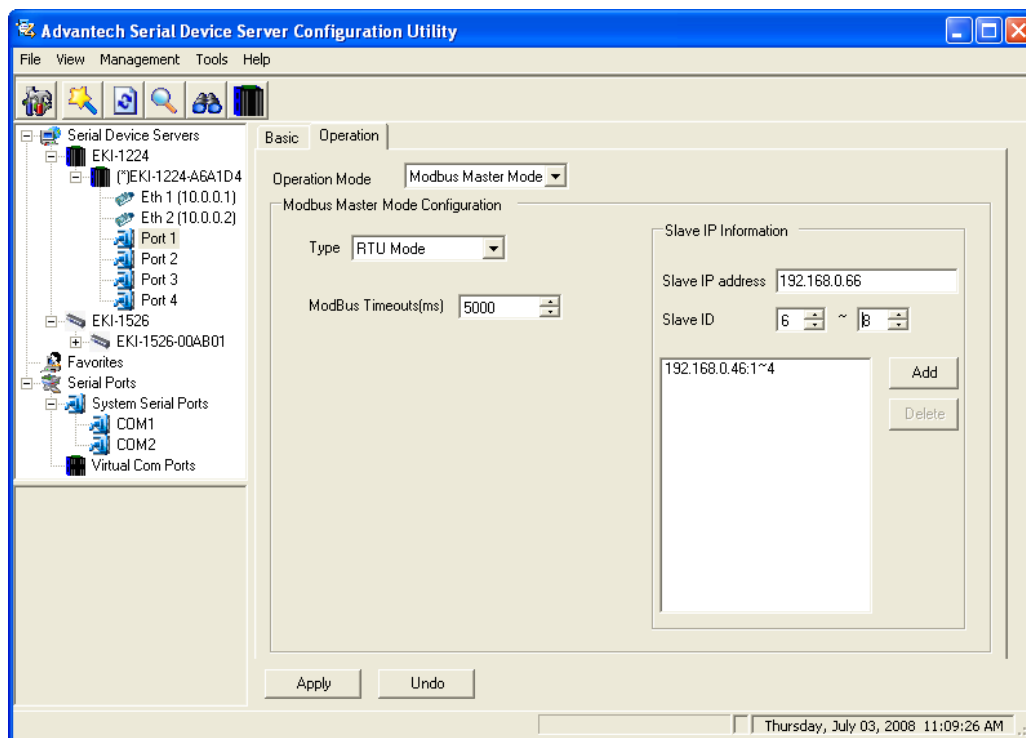
**Modbus Master Mode:****Type:**

This option specifies whether the Modbus RTU or Modbus ASCII master device is connected to the serial port.

**Modbus Timeouts (ms):**

This option specifies the time duration in milliseconds for the EKI-1221/1222/1224 to wait for a response after it has issued a command while using Modbus/RTU or Modbus ASCII. After the timeout is expired and no response is received, the EKI-1221/1222/1224 will regard the command as failed.

**ASCII Character Timeouts (ms):**

This option specifies the time interval in milliseconds between characters within the Modbus/ASCII message. If a greater interval occurs, the receiving device assumes an error has occurred.

**Slave IP Information:**

This option specifies the slave IP address and slave ID of the Modbus TCP slave device or another EKI-1221/1222/1224 acts the Modbus slave device. Type the IP address in the column and its slave ID range, then click “Add” or “Delete” button to add or remove the slave IP list.

## 3.6 Function Accessible Setting

The EKI-1221/1222/1224 provides a security function that the utility allows to set up an accessible IP list for Modbus TCP devices which can access data from Modbus data gateway.

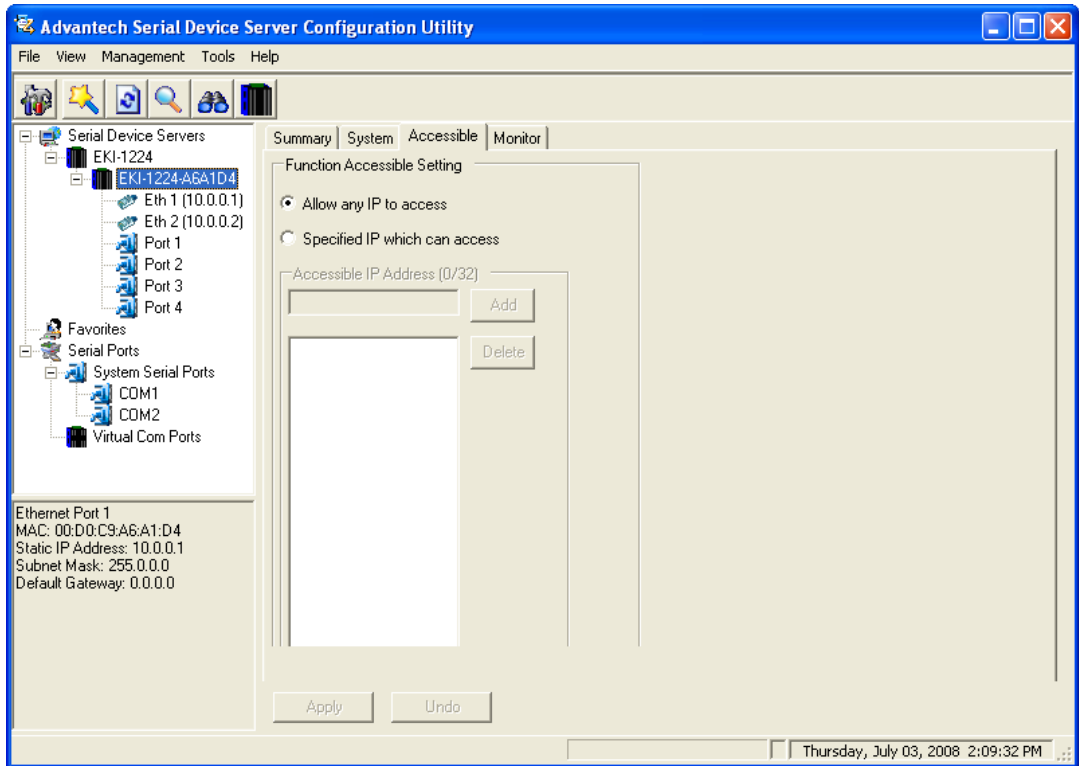

### Allow any IP access:

The default option, any Modbus TCP device can communicate with this Modbus data gateway.

### Specified IP which can access:

Type the IP address in the column and click "Add" or "Delete" button to make the accessible IP address list. The limit of this list is 32 IP addresses.



### 3.7 Monitoring Modbus Status

Configuration utility provides an excellent function that allows monitoring the serial ports' status. It will present each serial port's operation mode and status. The IP address of the Modbus TCP device which is communicating with serial port will be list on the right window. Click "Refresh" button, the status will be refresh once. It will be auto refresh after click "Auto Refresh" and the time duration is depending on the setting (the default value is 1000ms).

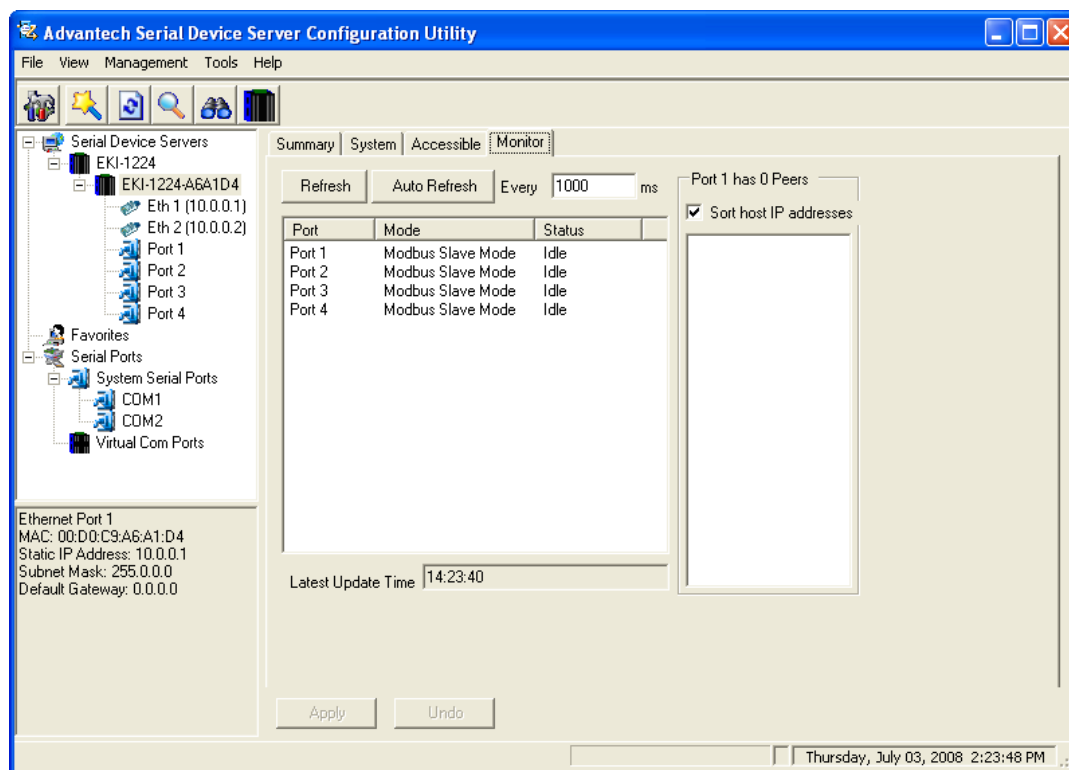

### 3.8 Administrator Setting

The configuration utility provides several administrator settings for easy management and configuration. Right click the mouse on the device name in the sub-tree of Serial Device Sever List Area, and select these administrator settings.



### 3.8.1 Import/Export Serial Port Setting

The utility allows importing or exporting the serial port setting including “Basic Setting” and “Operation Setting” via “.sps” file format.

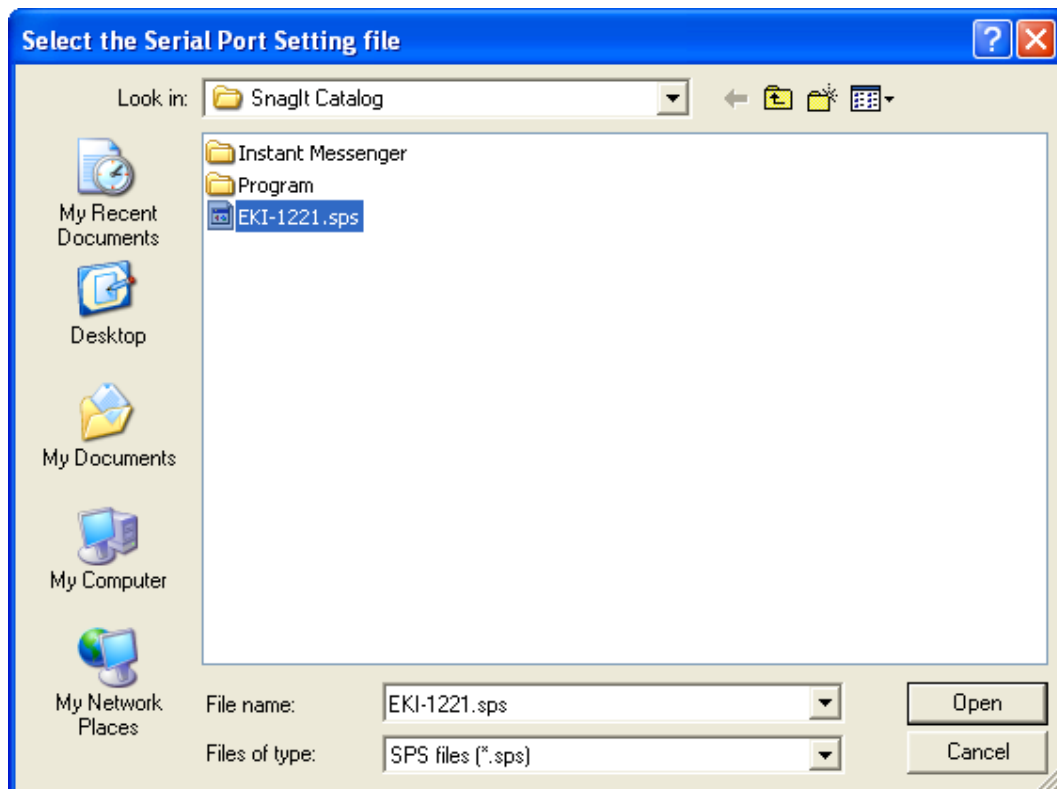

### 3.8.2 Locate the Modbus Data Gateway

If there are many Modbus data gateways need your management, you may need to identify which unit is correct to configuration on utility. Click “Locate” to make that unit’s “Status” LED be steady on until you click “Stop Locate”.

### 3.8.3 Lock Device

The configuration utility provides the “Lock Device” function to make it more confidential. You need to set up a password while the first time clicking “Lock Device”. Be sure to click “Reset Device” to restart the Modbus gateway and store your setting password into the memory.

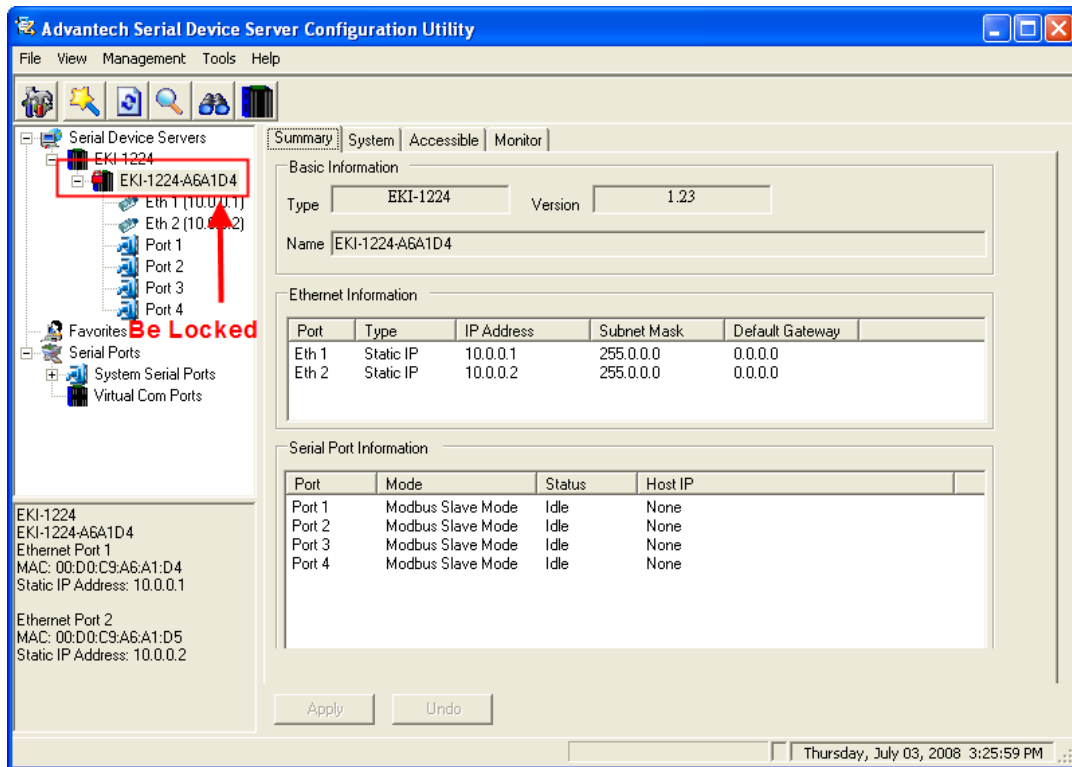

Click “Unlock Device” to unlock the Modbus data gateway, and you need to fill in the password you have set up before. If you forgot the password, the only way to solve this problem is to restore the setting of the Modbus data gateway to the factory default which will be introduced next section.

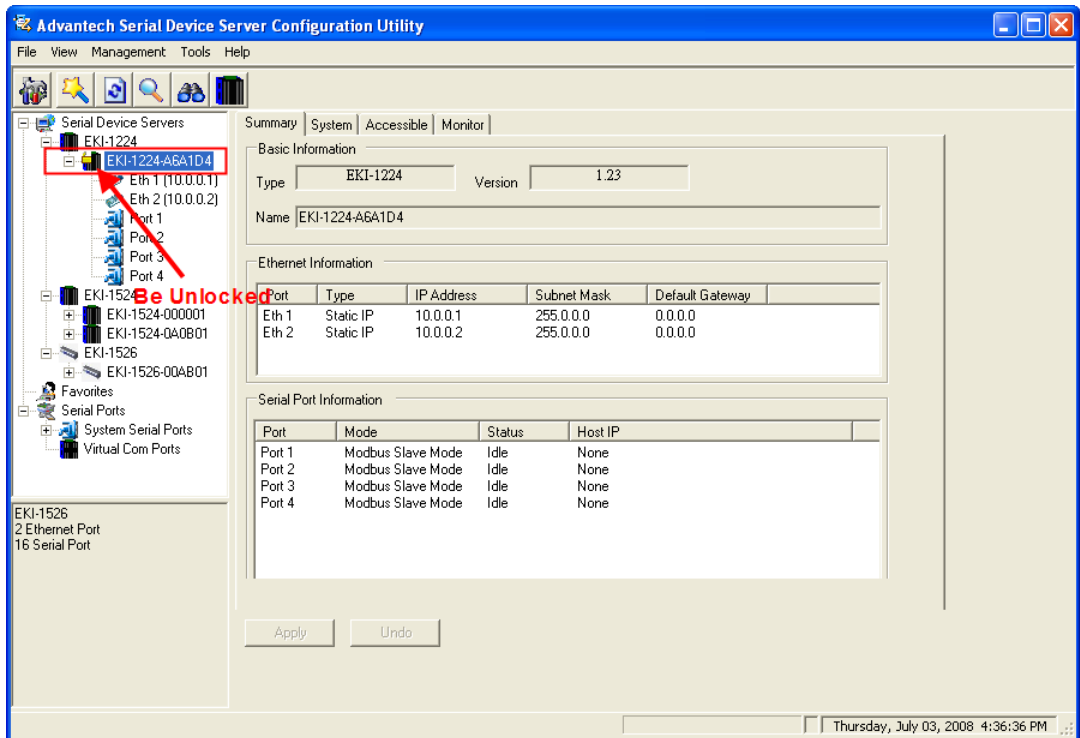

If you want to disable this function or change the password, click “Change Password” to change the password to default “None” (leave the new password and confirm new password columns blank) to disable this function or other password you want to change. Be sure to click “Reset Device” to restart the Modbus gateway and store the new password into the memory.

### 3.8.4 Restore to Factory Default Settings

The configuration utility provides this function to let you can restore the Modbus data gateway to factory default settings. The confirm message will be pop-up while clicking “Restore to Factory Default Settings”. If you really want to restore the Modbus data gateway to factory default settings, please click “Yes” button to continue.

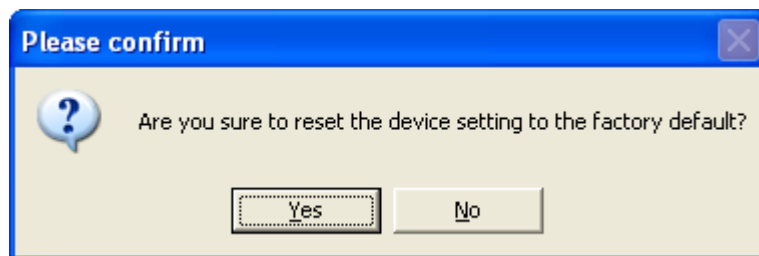

Then, please power off the Modbus data gateway within ten seconds, after reconnecting the power back, the all setting will be reset to the factory default. If the power remains more than ten seconds, the Modbus data gateway will not have any changes.

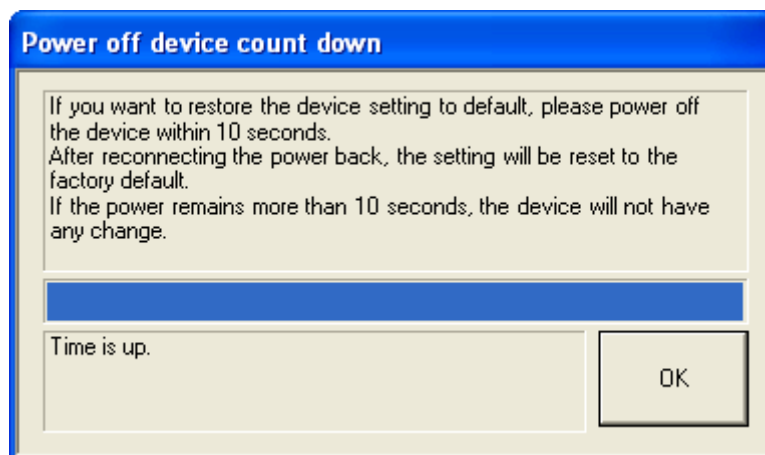

### 3.8.5 Update Firmware

Advantech continually upgrades its firmware to keep up with the ever-expanding world of computing. You can use the update firmware function in the utility to carry out the upgrade procedure. Please access Advantech's website: <http://www.advantech.com> to download the latest version of the firmware.

1. Right click on the device name and select "Update Firmware" function.

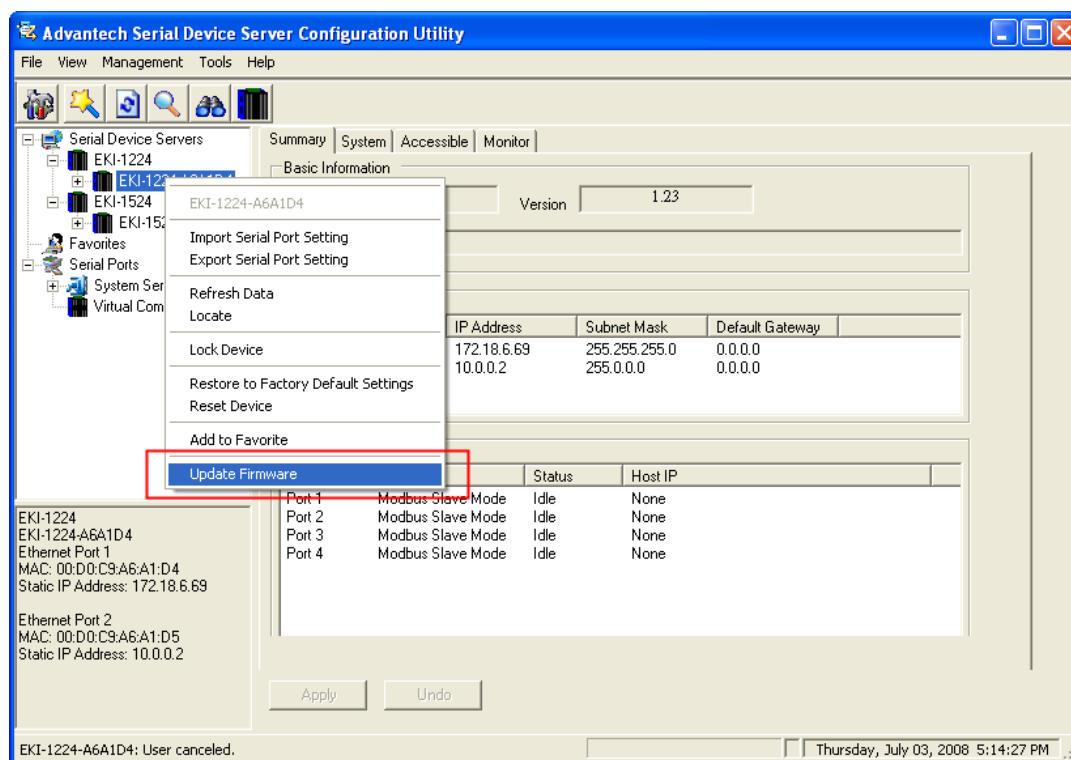

2. Select the firmware file you want to update.

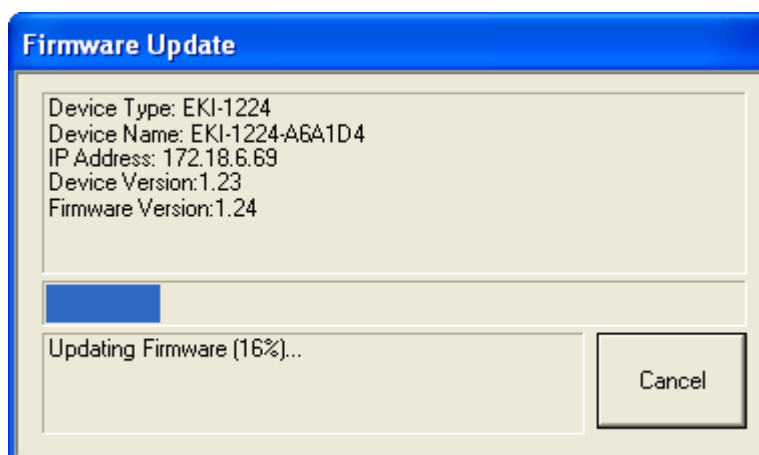
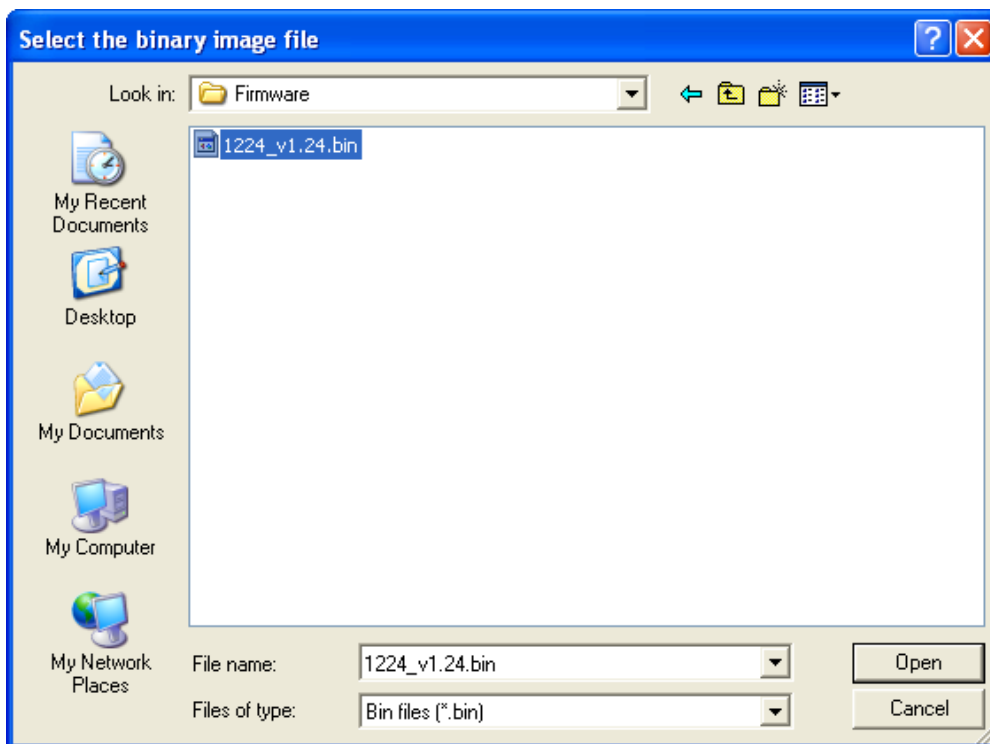

3. After downloading the firmware completely, click "OK" button, and the Modbus data gateway will restart automatically.

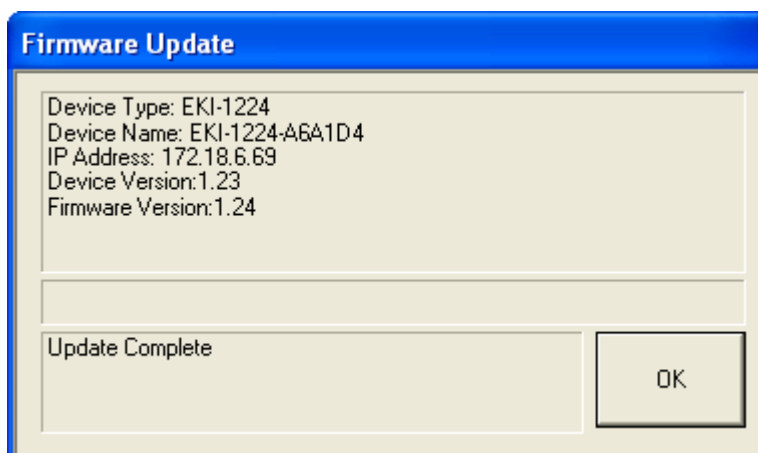



# ADVANTECH

## *eAutomation*

[www.advantech.com](http://www.advantech.com)

Please verify specifications before quoting. This guide is intended for reference purposes only.

All product specifications are subject to change without notice.

No part of this publication may be reproduced in any form or by any means, electronic, photocopying, recording or otherwise, without prior written permission of the publisher.

All brand and product names are trademarks or registered trademarks of their respective companies.

© Advantech Co., Ltd. 2008